



14th Balkan Cadet & Junior 3th U21 18th Children

SERBIA - Kragujevac

29/3/2013 - 31/3/2013

Male Kata Children Born1999

Entries: 24

GRE364 A.KOGIAS []
CYR324 S.PETRIDIS []
BUL319 P.PENEV []
<BYE>
FYR310 R.MUSTAFOVSKI []
HUN306 Z.GULYAS []
SRB376 U.VUKMIROVIC []
<BYE>
MNE244 V.MIJAC []
BIH427 F.SIJERCIC []
BUL328 E.TASKOV []
<BYE>
FYR384 K.VASILESKI []
GRE389 A.STEFANOPOULOS
TUR797 G.ILGEZDI []
<BYE>
FYR399 S.MERIPUSHKOSKI [
BUL251 V.PAVLOV [Gsh/Sho]
TUR681 A.TEBER []
<BYE>
MNE189 S.STANCOVIC [Gsh/
BIH362 E.MUSANOVIC [Gsh/D
SRB368 M.STANKOVIC []
<BYE>
GRE594 I.AARON [Enpi]
BIH295 A.HALILOVIC [Unsu]
ALB151 B.CAPI []
<BYE>
SRB508 D.RAKIC [Gsh/Sho]
TUR690 M.KARA [Gsh/Sho]
MNE303 A.TODOROVIC []
<BYE>





14th Balkan Cadet & Junior 3th U21 18th Children

SERBIA - Kragujevac

29/3/2013 - 31/3/2013

Male Kata Children Born1999

Repechage Pool 1

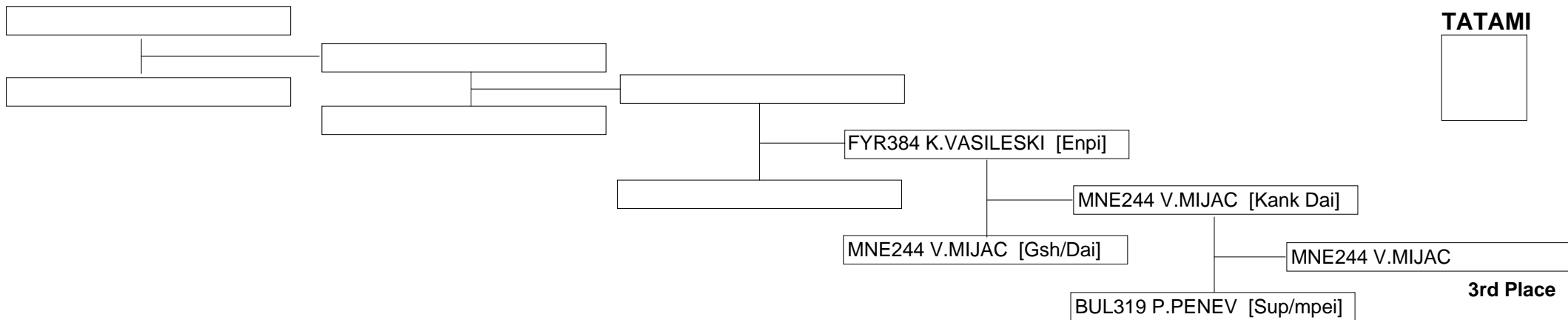

Repechage Pool 2

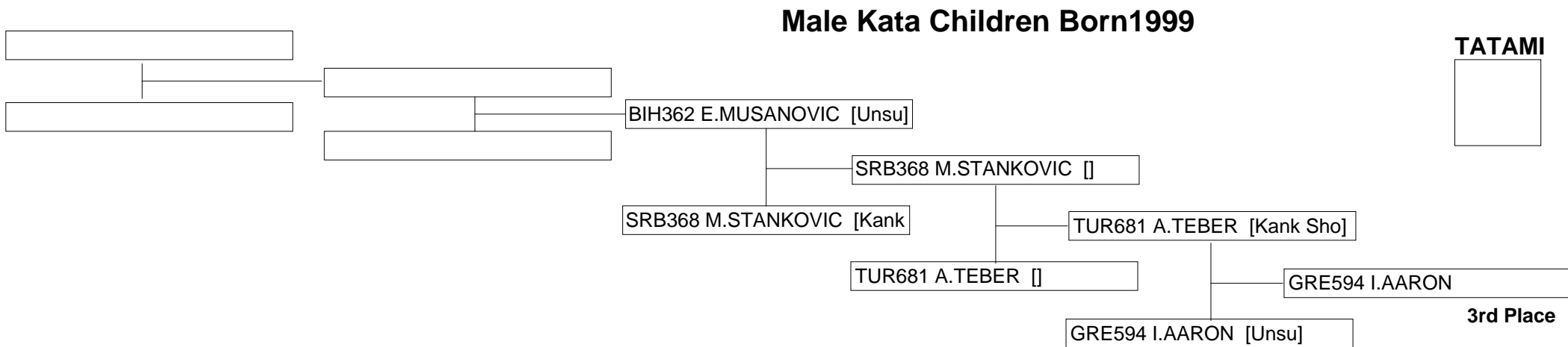



14th Balkan Cadet & Junior 3th U21 18th Children

SERBIA - Kragujevac

29/3/2013 - 31/3/2013

Male Kata Children Born 2000

Entries: 26

FYR380 Z.NIKOLOSKI []
BIH550 D.STOMORNJAK []
TUR773 A.BOLAT []
CYR267 A.THEODOSIOU []
MNE289 M.POPOVIC []
HUN275 A.GULYAS []
GRE495 A.BATIS []
<BYE>
MNE293 M.DUCIC []
GRE367 V.BOURAS []
TUR784 K.DURAN []
<BYE>
CYR258 A.LOUIS []
SRB321 B.KASPORSKI []
BUL309 T.KITANOV []
<BYE>
SRB342 S.SUVAJCEVIC []
FYR368 D.GULABOSKI []
BIH349 A.HAMAMDZIC []
HUN298 G.SZILAGYI []
CYR266 O.IOANNIDES [Sanse]
BUL305 I.ISAEV [Seipai]
TUR640 O.ARSLAN []
<BYE>
BUL358 R.HRISTOV [Seipai]
BIH355 M.KELESTURA [Enpi]
GRE521 C.XENOS []
<BYE>
FYR474 S.ILIEVSKI [Enpi]
SRB341 L.CEROVIC [Jion]
MNE272 D.COLOVIC []
<BYE>

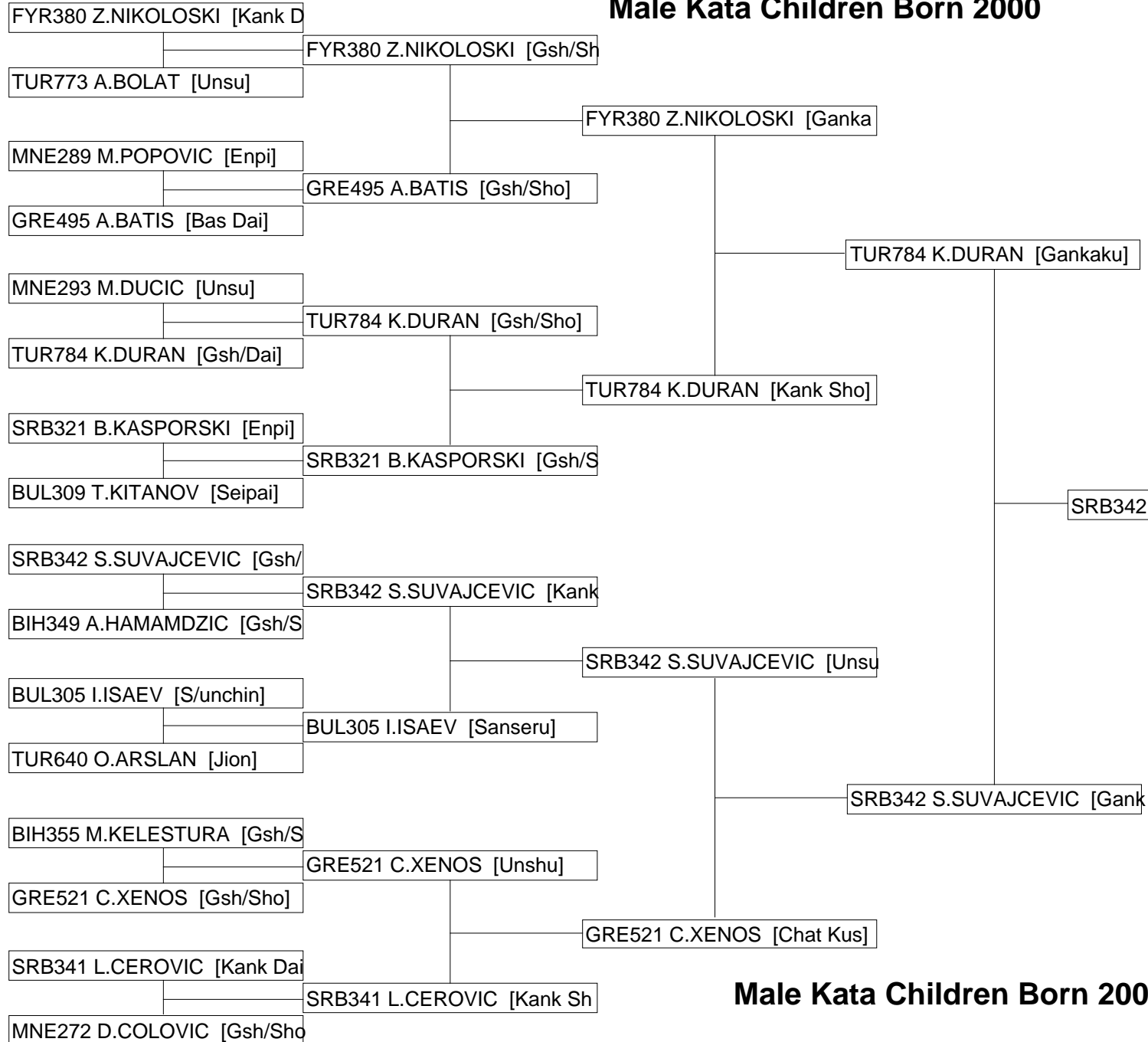

Male Kata Children Born 2000

Pool 1

TATAMI

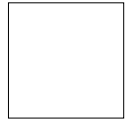

TATAMI

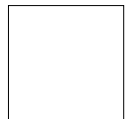

Pool 2



14th Balkan Cadet & Junior 3th U21 18th Children

SERBIA - Kragujevac

29/3/2013 - 31/3/2013

Male Kata Children Born 2000

Repechage Pool 1

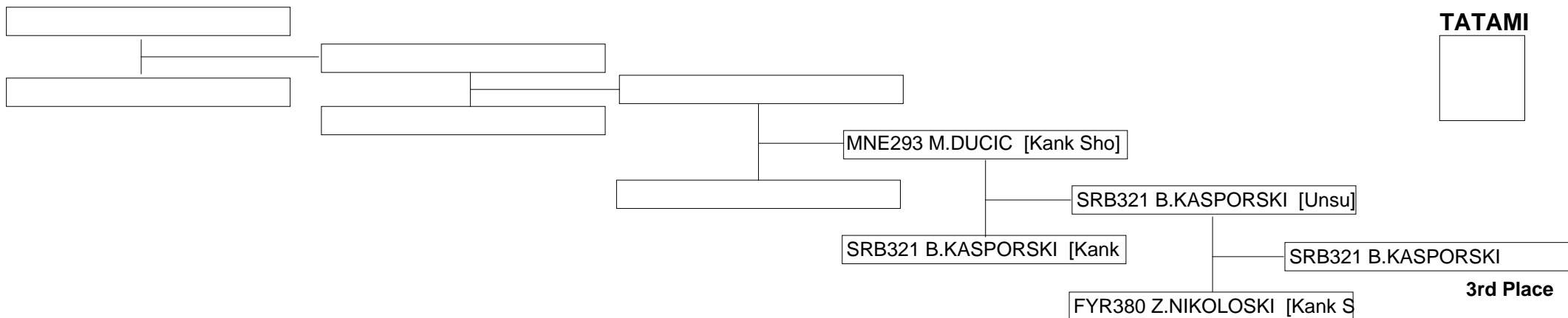

Repechage Pool 2

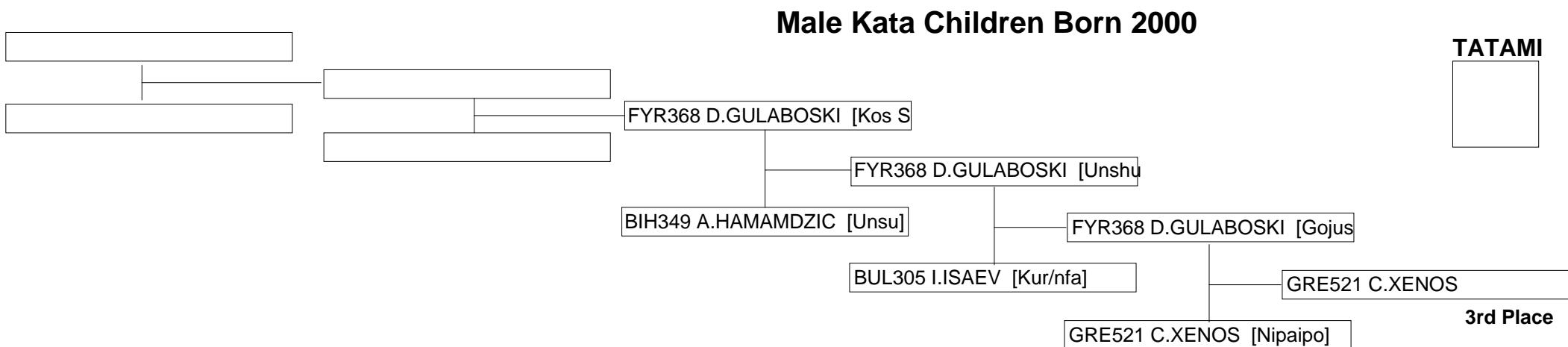



14th Balkan Cadet & Junior 3th U21 18th Children

SERBIA - Kragujevac

29/3/2013 - 31/3/2013

Male Kata Children Born 2001

Entries: 22

FYR403 H.DIMITRIJEVSKI []
CYR196 S.NICOLAOU []
HUN311 B.KERTESZ []
<BYE>
CRO398 L.KOSCEVIC []
BUL352 D.DIMITROV []
BIH551 M.SUBASIC []
<BYE>
MNE382 M.RAMOVIC []
GRE554 D.GKERZELIS []
BUL342 R.ANDREOU []
<BYE>
FYR396 A.IDRIZ []
<BYE>
SRB386 D.KALACUN []
<BYE>
GRE580 M.SEGREDAKIS []
BIH516 I.SEHIC []
MNE302 A.LEKIC []
<BYE>
TUR660 Y.KARA []
BUL299 A.AHMEDOV []
SRB377 D.VUKOBRATOVIC []
<BYE>
FYR402 J.VASIKJ []
GRE539 P.KAPSALIS []
BIH406 M.SMAJLOVIC []
<BYE>
SRB518 A.SOJAT []
<BYE>
MNE376 A.KOCAN []
<BYE>



Pool 1

TATAMI



TATAMI

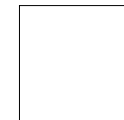

Pool 2

Male Kata Children Born 2001



14th Balkan Cadet & Junior 3th U21 18th Children

SERBIA - Kragujevac

29/3/2013 - 31/3/2013

Male Kata Children Born 2001

Repechage Pool 1

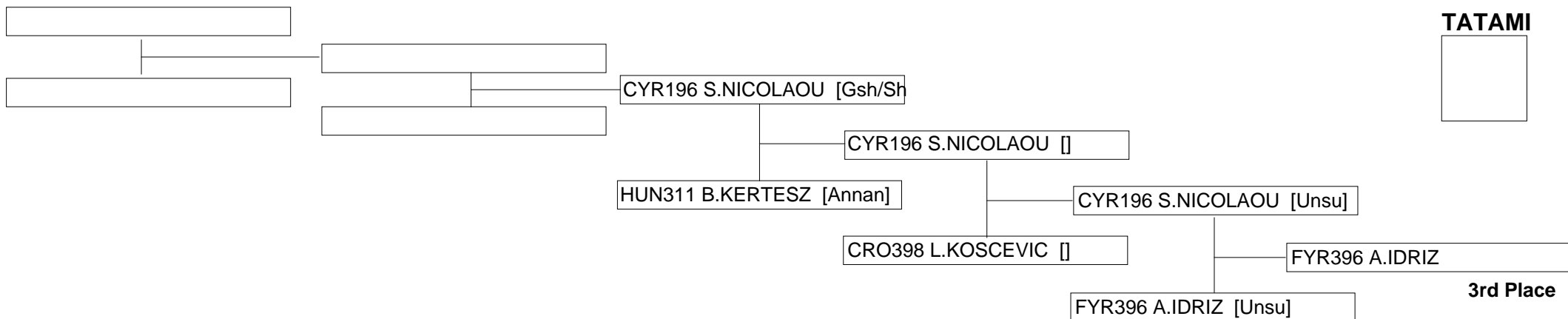

Repechage Pool 2

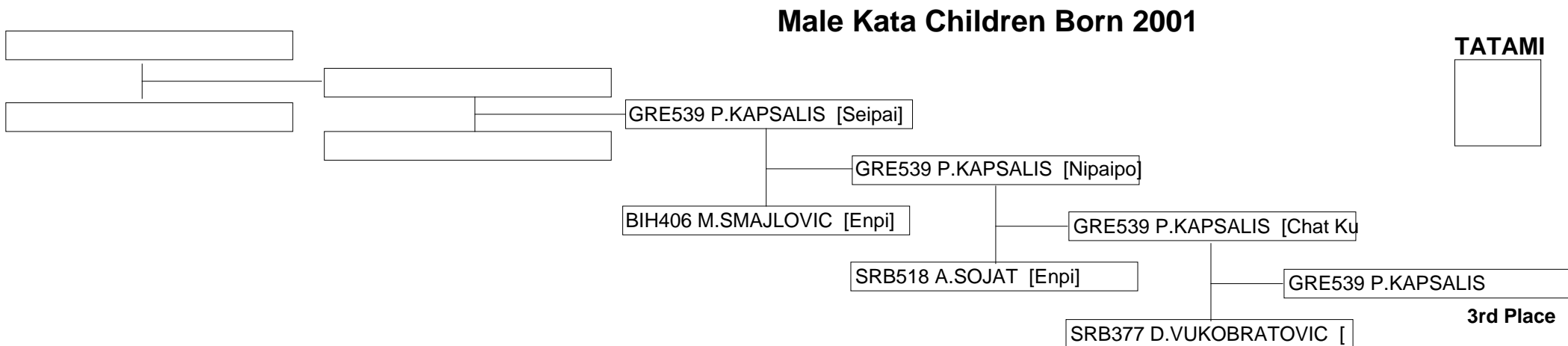



14th Balkan Cadet & Junior 3th U21 18th Children

SERBIA - Kragujevac

29/3/2013 - 31/3/2013

Male Kata Children Born 2002

Entries: 23

CRO400 D.PILJEK [Jion]
 MNE387 N.STANISIC [Gsh/Sh]
 FYR495 M.BUNTESKI []
 <BYE>

MNE387 N.STANISIC [Jion]

FYR495 M.BUNTESKI [Kank D]

FYR495 M.BUNTESKI [Enpi]

FYR495 M.BUNTESKI [Gsh/Da]

Pool 1

BUL348 Y.ATANASOV [Kur/nfa]
 BIH498 H.MURADBASIC [Bas]

BUL348 Y.ATANASOV [Seisan]

GRE711 E.GOGAS [Annanko]

GRE711 E.GOGAS [Sei/chin]

TATAMI

GRE711 E.GOGAS []
 <BYE>

GRE752 A.PEDRINI [Sei/chin]
 BUL357 T.HRISTOV [Seipai]

BUL357 T.HRISTOV [Kur/nfa]

BUL357 T.HRISTOV [Seisan]

HUN300 B.BEKE []
 <BYE>

HUN300 B.BEKE []

MNE412 F.BAKIC [Jion]

TUR798 M.IYIKESICI [Gsh/Sho]
 MNE412 F.BAKIC [Gsh/Sho]

MNE412 F.BAKIC [Enpi]

MNE412 F.BAKIC [Kank Dai]

SRB511 D.RISTIC []
 <BYE>

SRB511 D.RISTIC [Bas Dai]

FYR465 A.NEDELKOVSKI

FYR465 A.NEDELKOVSKI [Gs]
 MNE380 K.NIKOCEVIC [Gsh/S]

FYR465 A.NEDELKOVSKI [Ka]

FYR465 A.NEDELKOVSKI [Gs]

TUR782 R.DOGAN []
 <BYE>

TUR782 R.DOGAN []

FYR465 A.NEDELKOVSKI [Un]

BUL373 R.REDZHEPI [Seipai]
 BIH493 S.MIDZIC [Jion]

BUL373 R.REDZHEPI [Kur/nfa]

SRB524 U.SUBOTA [Njsh/Sho]

SRB524 U.SUBOTA []
 <BYE>

SRB524 U.SUBOTA [Bas Sho]

FYR465 A.NEDELKOVSKI [Ga]

TATAMI

TUR781 O.DEMIREL []
 FYR525 A.SPASOVSKI []

FYR525 A.SPASOVSKI [Kank]

FYR525 A.SPASOVSKI []

GRE705 C.DELLIS []
 <BYE>

GRE705 C.DELLIS [Jion]

FYR525 A.SPASOVSKI [Enpi]

Pool 2

SRB432 L.KRESOVIC []
 <BYE>

SRB432 L.KRESOVIC [Bas Dai]

SRB432 L.KRESOVIC [Jion]

BIH514 A.SALKICEVIC []
 <BYE>

BIH514 A.SALKICEVIC [Bas D]

Male Kata Children Born 2002



14th Balkan Cadet & Junior 3th U21 18th Children

SERBIA - Kragujevac

29/3/2013 - 31/3/2013

Male Kata Children Born 2002

Repechage Pool 1

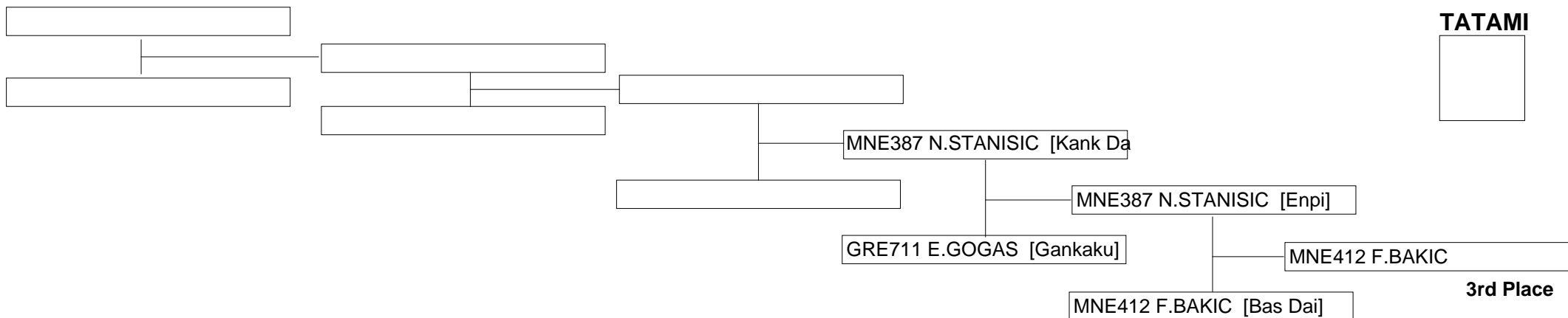

Repechage Pool 2

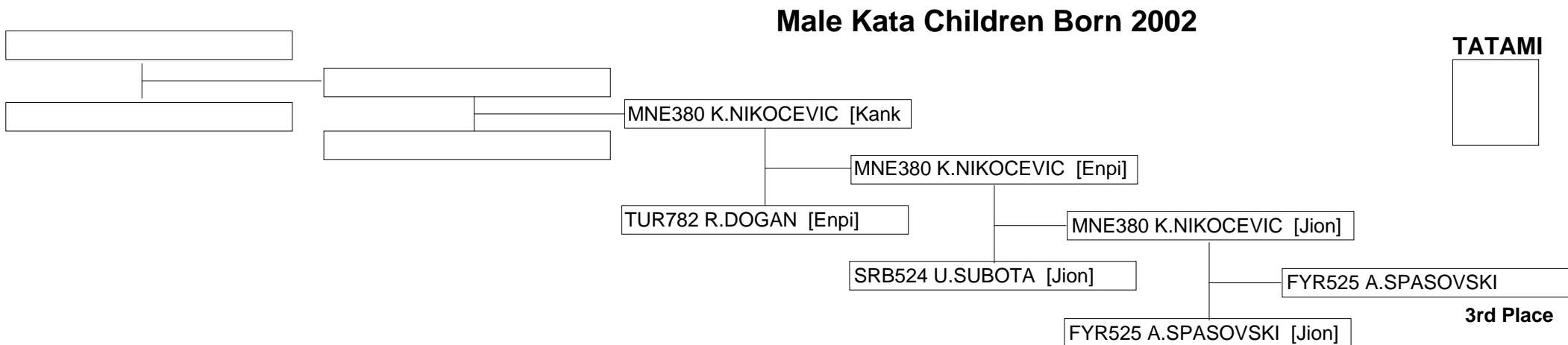



14th Balkan Cadet & Junior 3th U21 18th Children

SERBIA - Kragujevac

29/3/2013 - 31/3/2013

Female Kata Children Born1999

Entries: 18

FYR379 A.SAVIK []
TUR654 A.DUZGEL []
SRB345 N.DJURDJEVIC []
<BYE>
GRE392 C.ZARRA []
<BYE>
MNE195 J.MARIC []
<BYE>
SRB310 A.JANKOVIC []
<BYE>
GRE706 M.EVAGGELAKOU []
<BYE>
TUR643 H.BASKAYA []
<BYE>
BIH472 M.JAKIC []
<BYE>
MNE402 E.PALJEVIC [Gsh/Sh]
GRE393 E.KOUSOULI [Jion]
FYR297 T.CVETKOVSKA []
<BYE>
BIH284 A.TAHIROVIC []
<BYE>
TUR821 B.TURGUT []
<BYE>
FYR333 A.MATESKA []
<BYE>
BIH494 M.MOSTARAC []
<BYE>
SRB383 E.GOJACIC []
<BYE>
MNE282 M.ROGANOVIC []
<BYE>

TUR654 A.DUZGEL [Gsh/Sho]
SRB345 N.DJURDJEVIC [Gsh/]
SRB345 N.DJURDJEVIC [Enpi]
GRE392 C.ZARRA [Gsh/Sho]
MNE195 J.MARIC [Kank Dai]
MNE195 J.MARIC [Gsh/Sho]
SRB310 A.JANKOVIC [Gsh/Sh]
SRB310 A.JANKOVIC [Gsh/Dai]
GRE706 M.EVAGGELAKOU [Gsh/Sho]
TUR643 H.BASKAYA [Kank Dai]
TUR643 H.BASKAYA [Gsh/Sho]
BIH472 M.JAKIC [Gsh/Sho]
MNE402 E.PALJEVIC [Kank Sh]
MNE402 E.PALJEVIC [Kank D]
FYR297 T.CVETKOVSKA [Enpi]
BIH284 A.TAHIROVIC [Gsh/Sh]
BIH284 A.TAHIROVIC [Enpi]
TUR821 B.TURGUT [Enpi]
FYR333 A.MATESKA [Kos Sho]
BIH494 M.MOSTARAC [Gsh/S]
BIH494 M.MOSTARAC [Enpi]
SRB383 E.GOJACIC [Jion]
SRB383 E.GOJACIC [Kank Sh]
MNE282 M.ROGANOVIC [Jion]

MNE195 J.MARIC [Gsh/Dai]

MNE195 J.MARIC [Kank Dai]

MNE195 J.MARIC [Kank Sho]

SRB310 A.JANKOVIC [Gsh/Dai]

TUR643 H.BASKAYA [Gsh/Dai]

TUR643 H.BASKAYA [Gsh/Sho]

MNE195 J.MARIC

BIH284 A.TAHIROVIC [Unsu]

BIH284 A.TAHIROVIC [Enpi]

BIH284 A.TAHIROVIC [Kank D]

BIH494 M.MOSTARAC [Gsh/S]

SRB383 E.GOJACIC [Unsu]

Pool 1

TATAMI

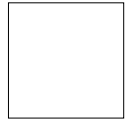

TATAMI

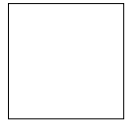

Pool 2

Female Kata Children Born1999



14th Balkan Cadet & Junior 3th U21 18th Children

SERBIA - Kragujevac

29/3/2013 - 31/3/2013

Female Kata Children Born1999

Repechage Pool 1

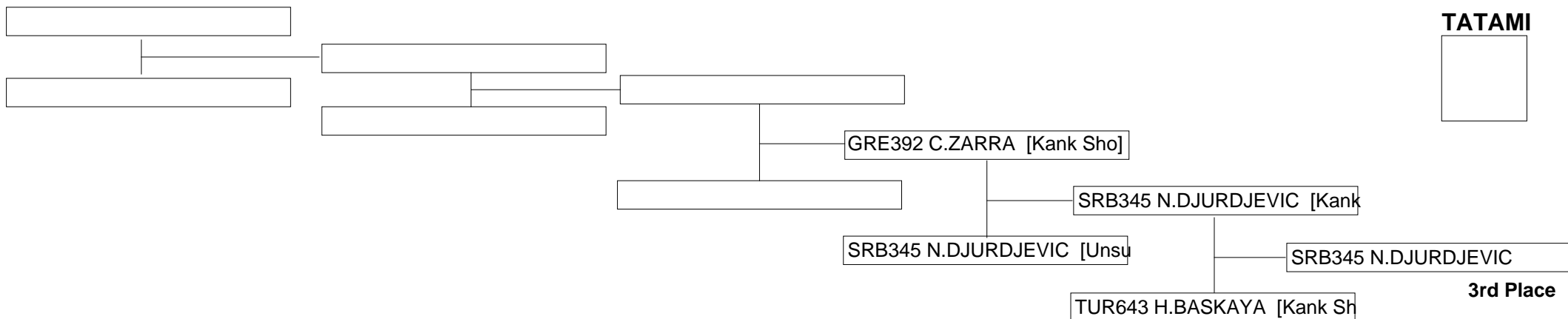

Repechage Pool 2

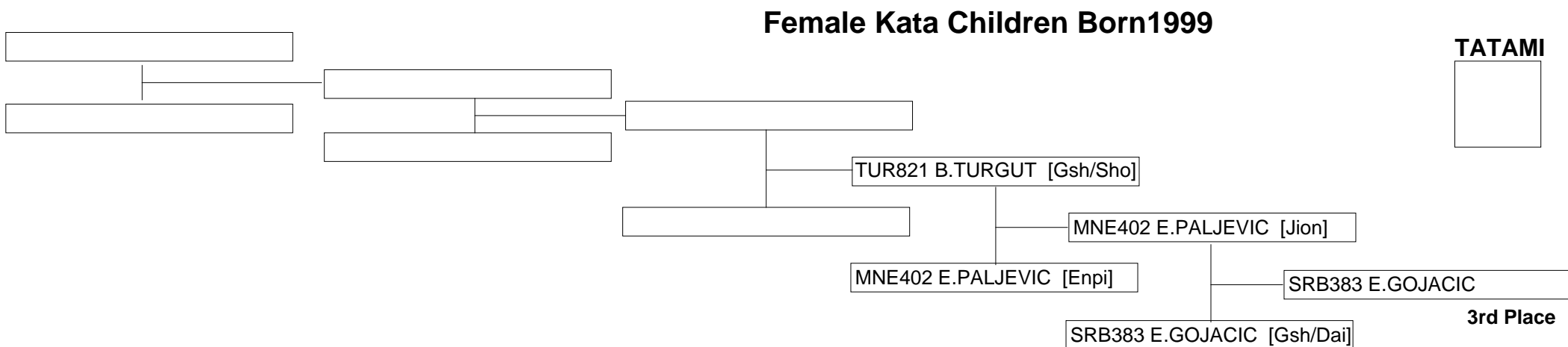



14th Balkan Cadet & Junior 3th U21 18th Children

SERBIA - Kragujevac

29/3/2013 - 31/3/2013

Female Kata Children Born 2000

Entries: 22

CYR274 N.THEOCHARIDOU []
SRB365 J.SIMIC [Jion]

SRB365 J.SIMIC []

BIH462 A.GRAHIC []
<BYE>

BIH462 A.GRAHIC []

CRO382 A.CUK [Enpi]
FYR364 L.DIMESKA [Sup/mpei]

FYR364 L.DIMESKA []

GRE528 N.GKONOU []
<BYE>

GRE528 N.GKONOU []

TUR819 M.TASSCI [Jion]
FYR363 K.KAMCHESKA [Anna]

TUR819 M.TASSCI []

MNE300 V.BUJIC []
<BYE>

MNE300 V.BUJIC []

BUL304 I.GORANOVA []
<BYE>

BUL304 I.GORANOVA [Jion]

GRE576 A.PAPOUTSI []
<BYE>

GRE576 A.PAPOUTSI [Kank D

MNE273 D.CIROVIC [Enpi]
TUR814 N.SARA [Jion]

MNE273 D.CIROVIC [Kank Sh

BUL361 Z.IVANOVA []
<BYE>

BUL361 Z.IVANOVA [Annan]

GRE516 P.THEODORAKOPOU
SRB455 A.DUCIC []

GRE516 P.THEODORAKOPOU

BIH351 L.JAKIC []
<BYE>

BIH351 L.JAKIC [Gsh/Sho]

CYR263 M.HADJIEFSTATHIOU
FYR360 M.TALESKA []

FYR360 M.TALESKA [Chat Ku

SRB385 L.JOVANOVIC []
<BYE>

SRB385 L.JOVANOVIC [Enpi]

MNE413 A.MIJOVIC []
<BYE>

MNE413 A.MIJOVIC [Gsh/Sho]

BIH389 A.GAPA []
<BYE>

BIH389 A.GAPA [Jion]

SRB365 J.SIMIC []

FYR364 L.DIMESKA []

TUR819 M.TASSCI []

GRE576 A.PAPOUTSI []

MNE273 D.CIROVIC []

GRE516 P.THEODORAKOPOU

SRB385 L.JOVANOVIC []

BIH389 A.GAPA []

SRB365 J.SIMIC []

TUR819 M.TASSCI []

GRE516 P.THEODORAKOPOU

SRB385 L.JOVANOVIC []

TUR819 M.TASSCI [Jion]

TUR819 M.TASSCI

GRE516 P.THEODORAKOPOU

Pool 1

TATAMI

TATAMI

Pool 2

Female Kata Children Born 2000



14th Balkan Cadet & Junior 3th U21 18th Children

SERBIA - Kragujevac

29/3/2013 - 31/3/2013

Female Kata Children Born 2000

Repechage Pool 1

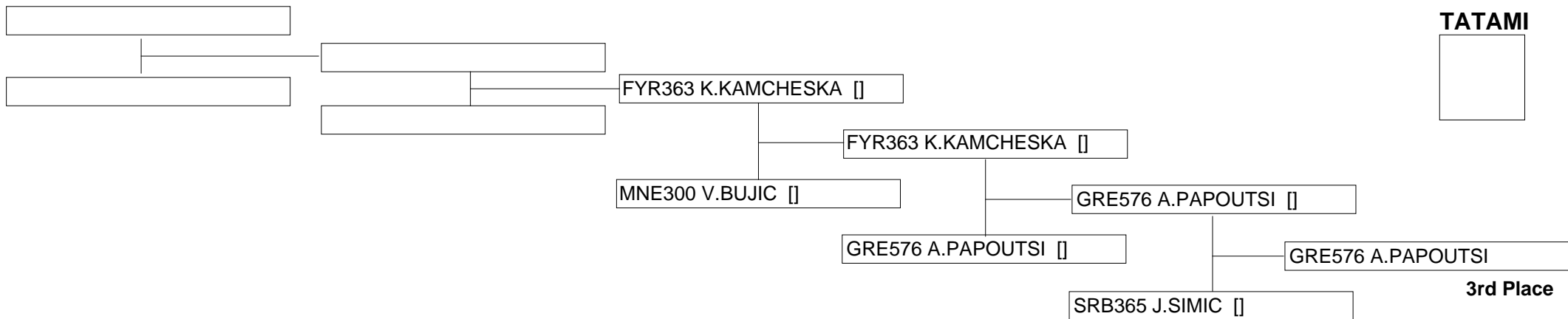

Repechage Pool 2

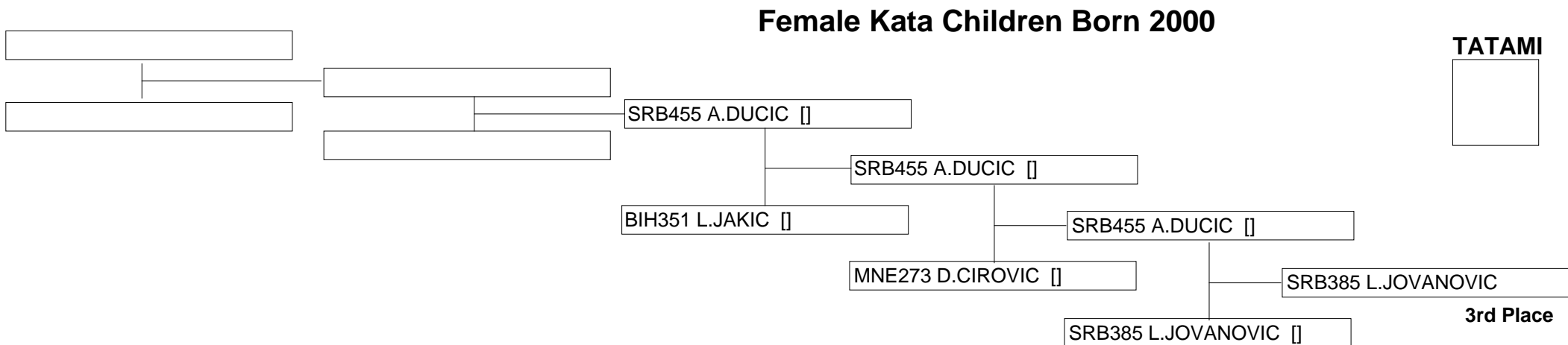



14th Balkan Cadet & Junior 3th U21 18th Children

SERBIA - Kragujevac

29/3/2013 - 31/3/2013

TUR807 S.OKUNAK []
HUN283 Z.BANOVICS []
SRB358 D.PJEVAC []
<BYE>
FYR390 K.ANDONOVSKA []
<BYE>
MNE295 I.BUJKOVIC []
<BYE>
GRE572 C.NIKA []
HUN272 Z.BARANYI []
FYR397 M.KOCH []
<BYE>
SRB370 M.VARSAKOVIC []
<BYE>
BIH520 A.SULJIC []
<BYE>
FYR393 V.DUNIMAGLOSKA []
GRE593 N.ZERVOU []
BIH467 B.HASKIC []
<BYE>
HUN315 L.LELKES []
<BYE>
SRB517 E.SOJAT []
<BYE>
MNE299 N.RADACIC []
BIH369 M.RADIC []
GRE570 F.MPATSILA []
<BYE>
BUL311 A.KOSTADINOVA []
<BYE>
TUR779 Z.CELIK []
<BYE>

TUR807 S.OKUNAK []
SRB358 D.PJEVAC []
SRB358 D.PJEVAC []
FYR390 K.ANDONOVSKA []
MNE295 I.BUJKOVIC []
MNE295 I.BUJKOVIC []
GRE572 C.NIKA []
FYR397 M.KOCH []
GRE572 C.NIKA []
FYR397 M.KOCH []
SRB370 M.VARSAKOVIC []
BIH520 A.SULJIC []
BIH520 A.SULJIC []
GRE593 N.ZERVOU []
GRE593 N.ZERVOU []
BIH467 B.HASKIC []
HUN315 L.LELKES []
HUN315 L.LELKES []
SRB517 E.SOJAT []
SRB517 E.SOJAT []
MNE299 N.RADACIC []
MNE299 N.RADACIC []
GRE570 F.MPATSILA []
GRE570 F.MPATSILA []
BUL311 A.KOSTADINOVA []
BUL311 A.KOSTADINOVA []
TUR779 Z.CELIK []
TUR779 Z.CELIK []

Female Kata Children Born 2001

Entries: 20

Pool 1

TATAMI

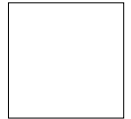

BIH520 A.SULJIC []

SRB358 D.PJEVAC [Jion]

GRE593 N.ZERVOU

GRE593 N.ZERVOU []

GRE593 N.ZERVOU [Unsu]

TATAMI

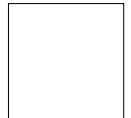

Pool 2

Female Kata Children Born 2001



14th Balkan Cadet & Junior 3th U21 18th Children

SERBIA - Kragujevac

29/3/2013 - 31/3/2013

Female Kata Children Born 2001

Repechage Pool 1

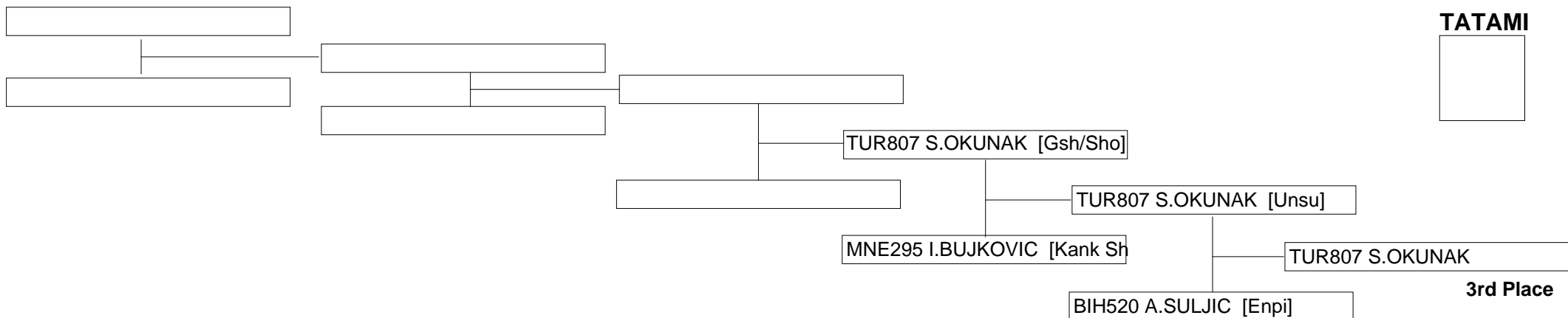

Repechage Pool 2

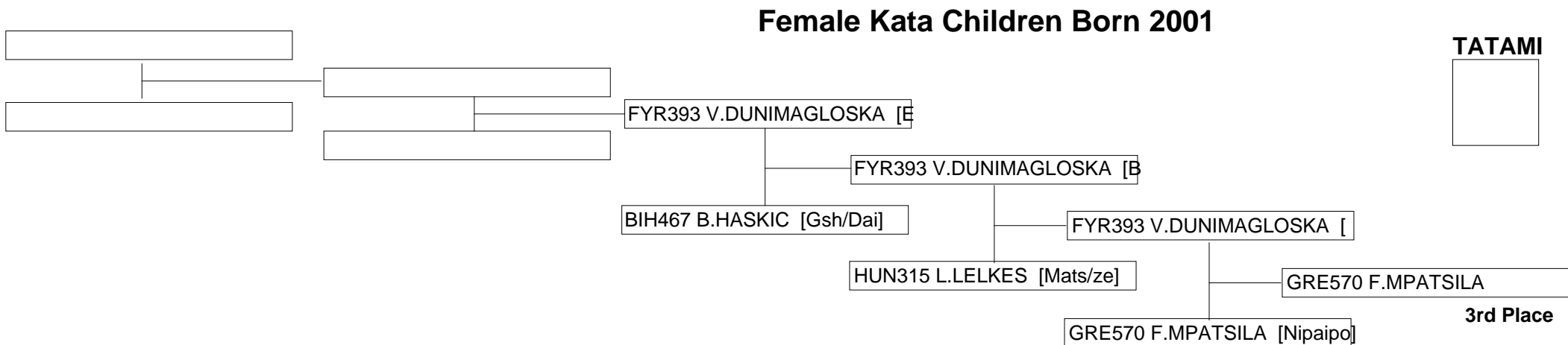



14th Balkan Cadet & Junior 3th U21 18th Children

SERBIA - Kragujevac

29/3/2013 - 31/3/2013

Female Kata Children Born 2002

Entries: 20

MNE400 M.MRAKOVIC [Gsh/S]
HUN273 Z.BENKO [Sup/mpei]
CRO397 N.CRNKOVIC []
<BYE>
FYR464 I.MUFTAROVA []
<BYE>
SRB536 D.ZIVKOVIC []
<BYE>
TUR765 A.ALTINBAS [Jion]
GRE736 G.LIBERI [Nipaipo]
BIH475 N.JOSIPOVIC []
<BYE>
BUL340 A.AHMEDOVA []
<BYE>
FYR462 V.AVRAMOVA []
<BYE>
GRE703 S.DAMASKINOVA [Jion]
FYR463 M.MANEVSKA [Enpi]
SRB470 V.KNEYEVIC []
<BYE>
MNE390 M.DJUKANOVIC []
<BYE>
BIH455 A.BECAREVIC []
<BYE>
BIH495 B.MUJANOVIC [Bas D]
GRE701 O.CHAVIAROPOULO
SRB456 M.GRUBOR []
<BYE>
TUR827 R.ZURNACI []
<BYE>
MNE403 S.RADJENOVIC []
<BYE>

MNE400 M.MRAKOVIC [Jion]
MNE400 M.MRAKOVIC [Kank]
CRO397 N.CRNKOVIC [Jion]
FYR464 I.MUFTAROVA [Enpi]
FYR464 I.MUFTAROVA [Kank]
SRB536 D.ZIVKOVIC [Enpi]
GRE736 G.LIBERI [Annan]
GRE736 G.LIBERI [Unshu]
BIH475 N.JOSIPOVIC [Jion]
GRE736 G.LIBERI [Jion]
BUL340 A.AHMEDOVA [Seipai]
FYR462 V.AVRAMOVA [Kank]
FYR462 V.AVRAMOVA [Kank]
FYR463 M.MANEVSKA [Gsh/D]
FYR463 M.MANEVSKA [Jion]
SRB470 V.KNEYEVIC [Jion]
MNE390 M.DJUKANOVIC [Jion]
MNE390 M.DJUKANOVIC [Gsh]
BIH455 A.BECAREVIC [Bas Da]
BIH495 B.MUJANOVIC [Jion]
BIH495 B.MUJANOVIC [Kank]
SRB456 M.GRUBOR [Jion]
BIH495 B.MUJANOVIC [Gsh/S]
TUR827 R.ZURNACI [Enpi]
TUR827 R.ZURNACI [Gsh/Sho]
MNE403 S.RADJENOVIC [Jion]

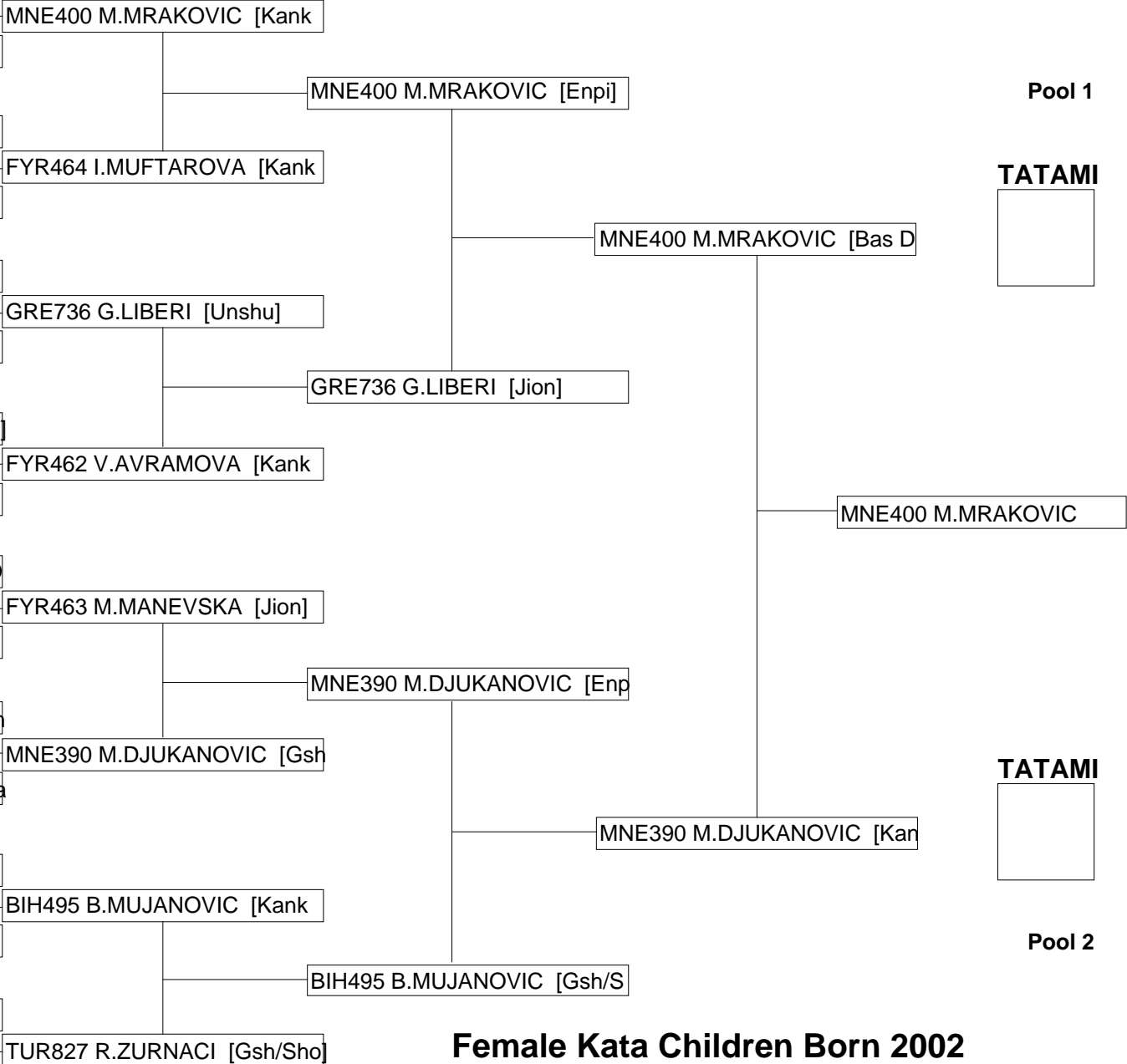

Pool 1

TATAMI

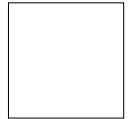

TATAMI

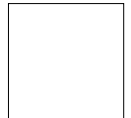

Pool 2

Female Kata Children Born 2002



14th Balkan Cadet & Junior 3th U21 18th Children

SERBIA - Kragujevac

29/3/2013 - 31/3/2013

Female Kata Children Born 2002

Repechage Pool 1

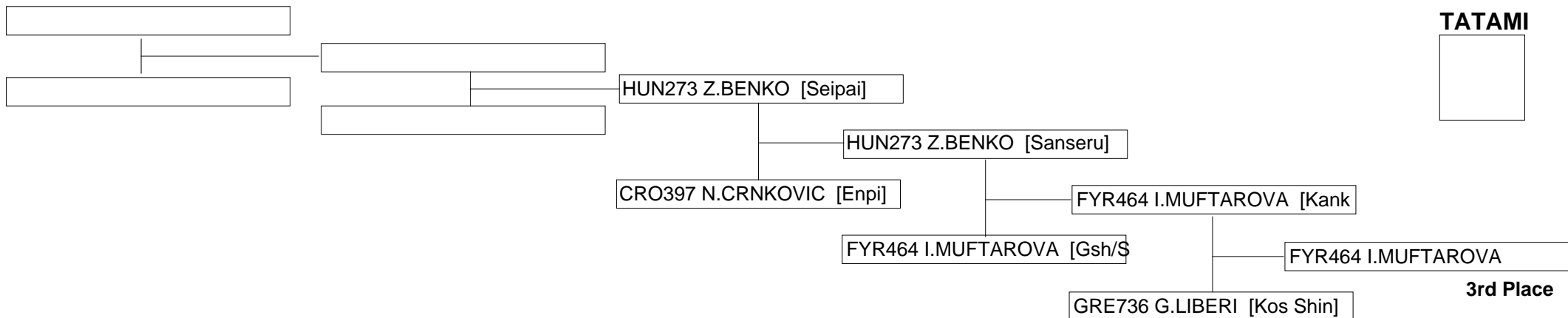

Repechage Pool 2

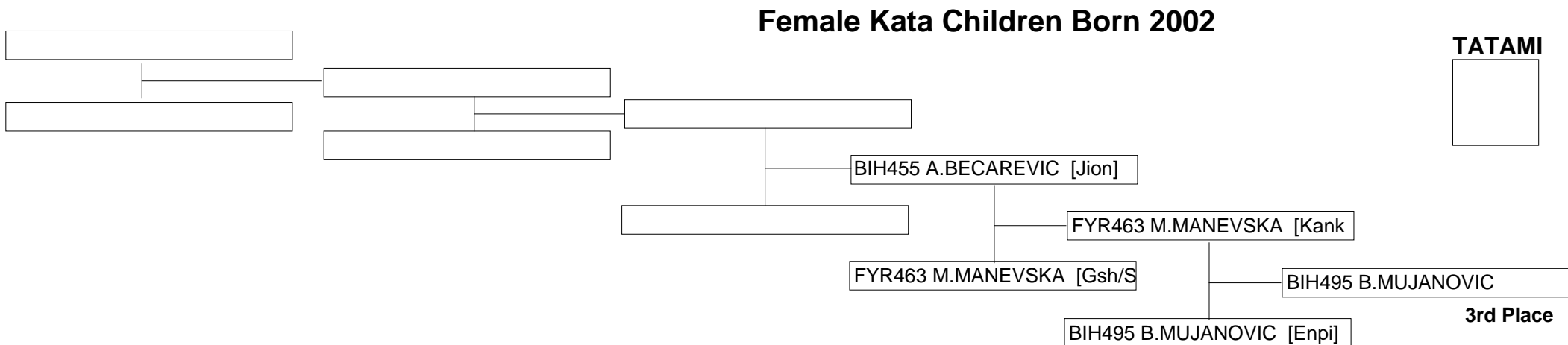



14th Balkan Cadet & Junior 3th U21 18th Children

SERBIA - Kragujevac

29/3/2013 - 31/3/2013

Male Tema Kata Children Born 1999-2000

Entries: 8

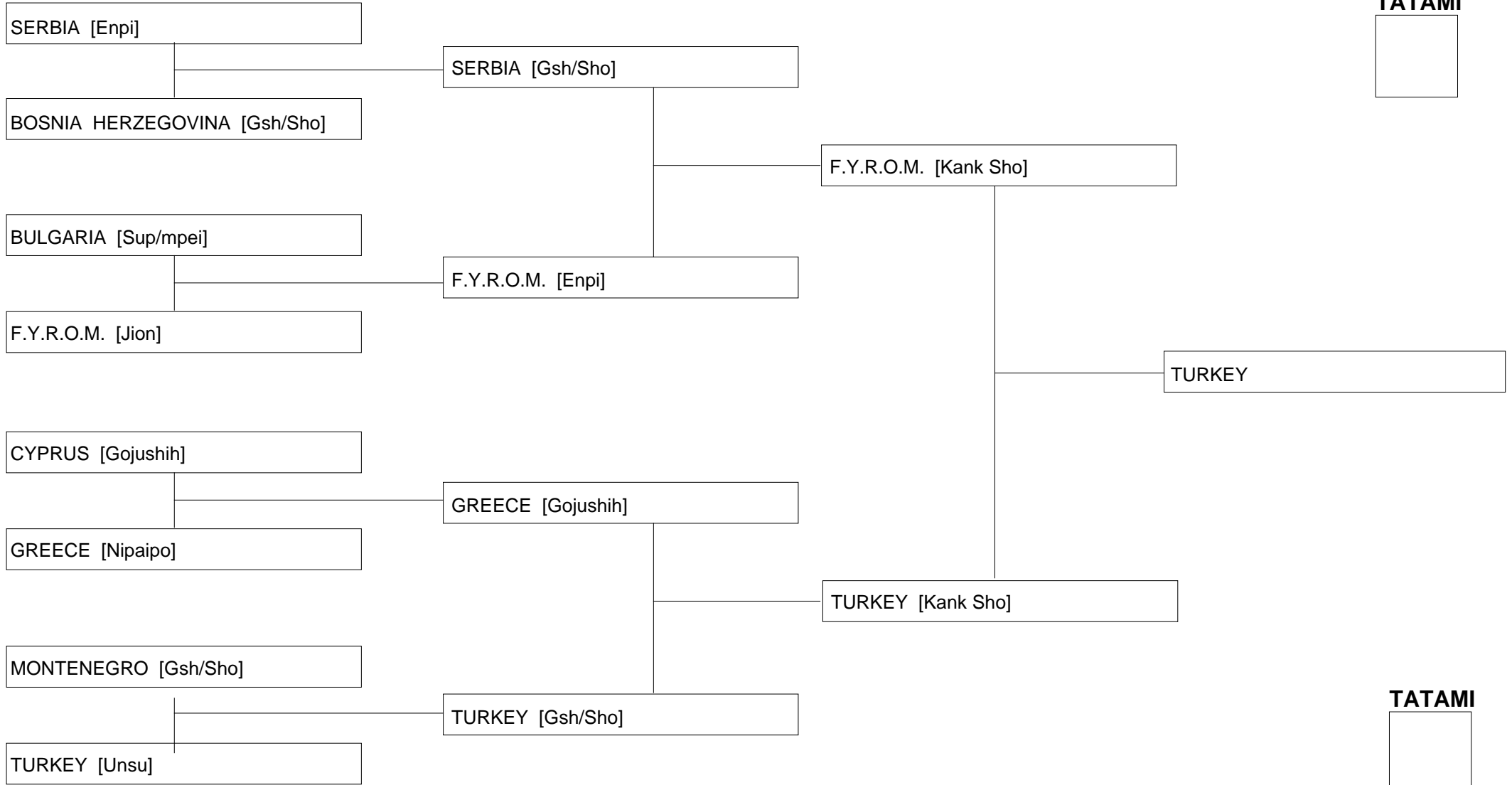

TATAMI

TATAMI

Male Tema Kata Children Born 1999-2000



14th Balkan Cadet & Junior 3th U21 18th Children

SERBIA - Kragujevac

29/3/2013 - 31/3/2013

Male Tema Kata Children Born 1999-2000

Repechage Pool 1

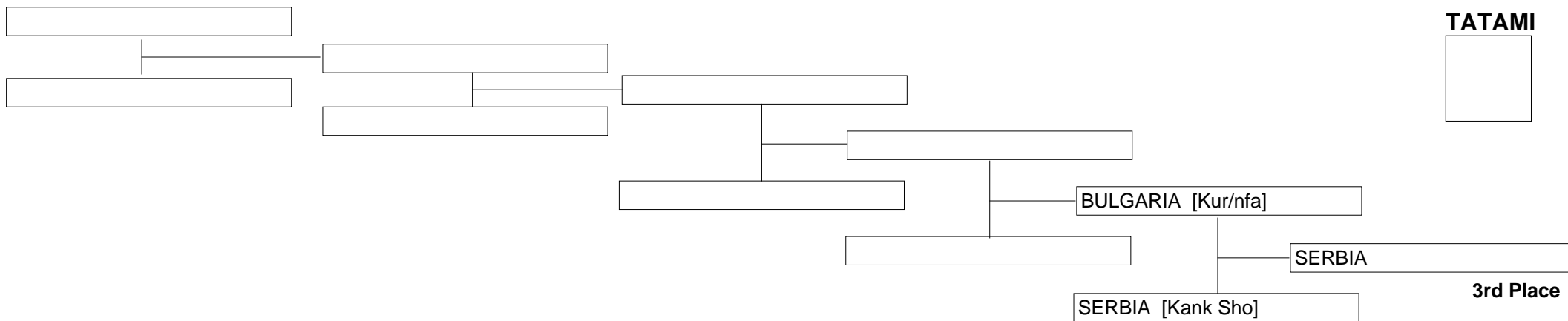

Repechage Pool 2

Male Tema Kata Children Born 1999-2000

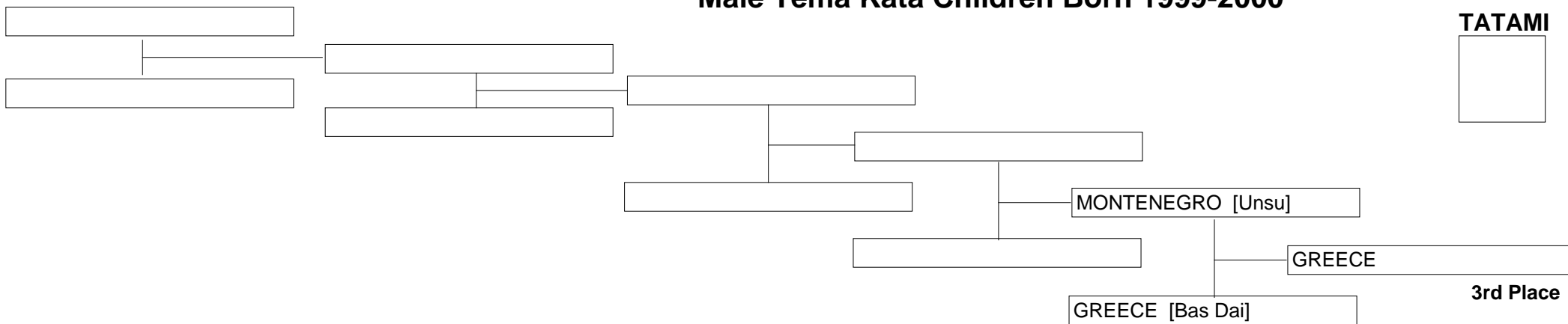



14th Balkan Cadet & Junior 3th U21 18th Children

SERBIA - Kragujevac

29/3/2013 - 31/3/2013

Male Tema Kata Children Born 2001-2002

Entries: 6

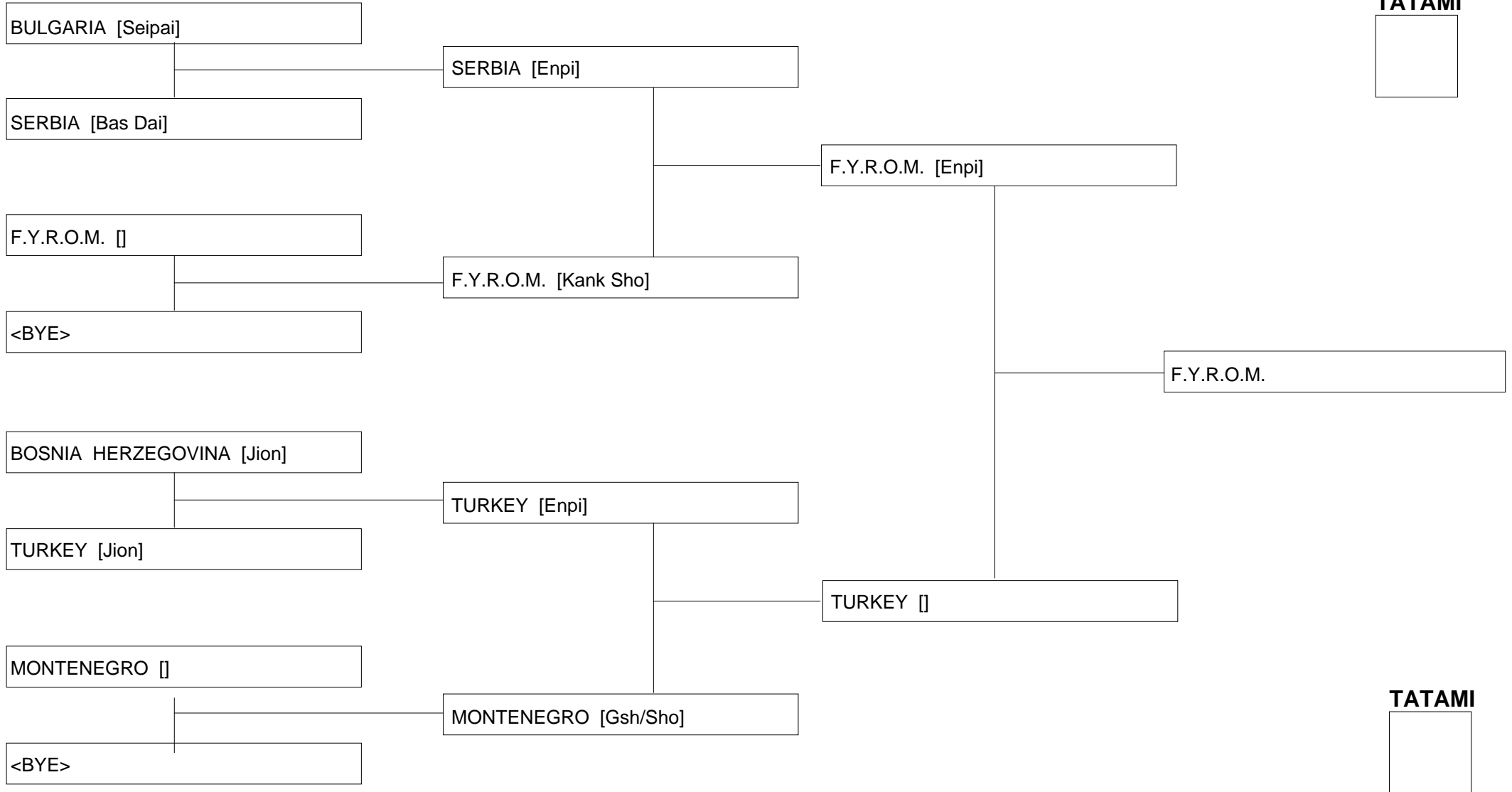

Male Tema Kata Children Born 2001-2002



14th Balkan Cadet & Junior 3th U21 18th Children

SERBIA - Kragujevac

29/3/2013 - 31/3/2013

Male Tema Kata Children Born 2001-2002

Repechage Pool 1

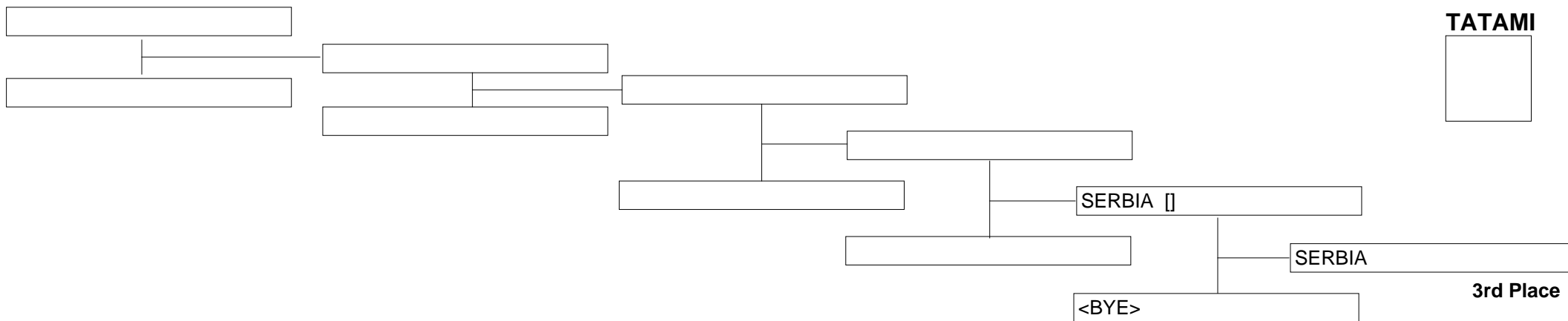

Repechage Pool 2

Male Tema Kata Children Born 2001-2002

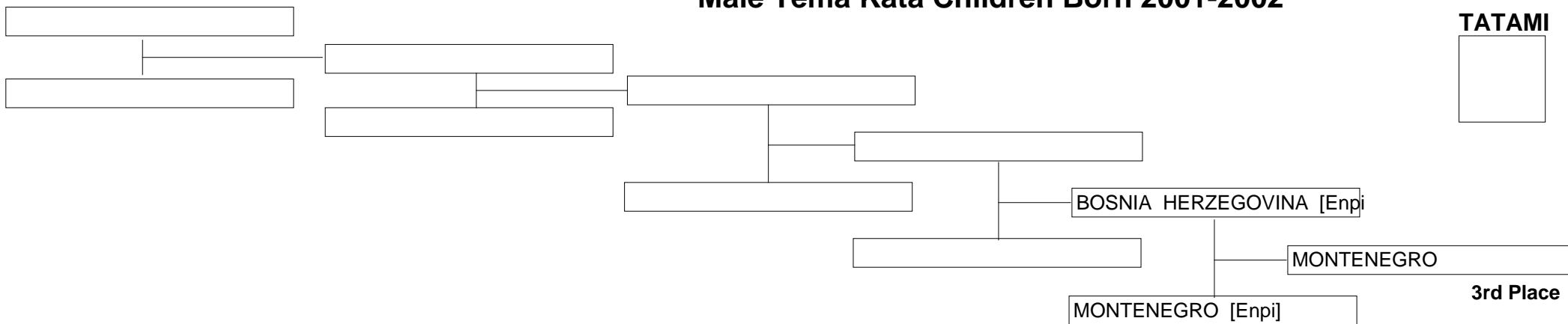



14th Balkan Cadet & Junior 3th U21 18th Children

SERBIA - Kragujevac

29/3/2013 - 31/3/2013

Female Team Kata Children Born 1999-2000

Entries: 6

MONTENEGRO [Gsh/Sho]

GREECE [Kank Sho]

SERBIA []

<BYE>

BOSNIA HERZEGOVINA [Enpi]

F.Y.R.O.M. [Tomari B]

TURKEY []

<BYE>

GREECE [Gsh/Sho]

SERBIA [Gsh/Sho]

F.Y.R.O.M. [Annan]

TURKEY [Gsh/Sho]

SERBIA [Kank Sho]

F.Y.R.O.M. [Sup/mpei]

SERBIA

TATAMI

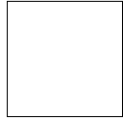

TATAMI

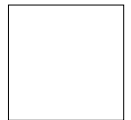

Female Team Kata Children Born 1999-2000



14th Balkan Cadet & Junior 3th U21 18th Children

SERBIA - Kragujevac

29/3/2013 - 31/3/2013

Female Team Kata Children Born 1999-2000

Repechage Pool 1

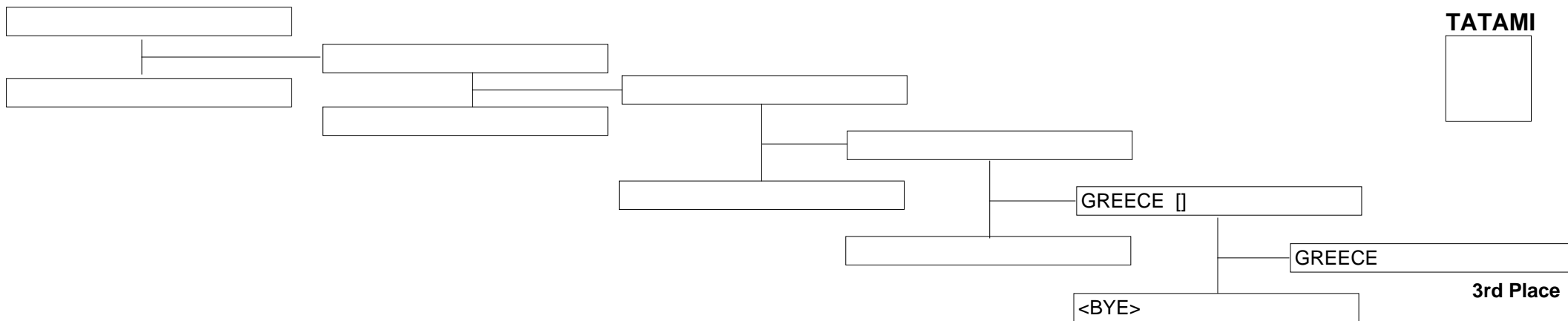

Repechage Pool 2

Female Team Kata Children Born 1999-2000

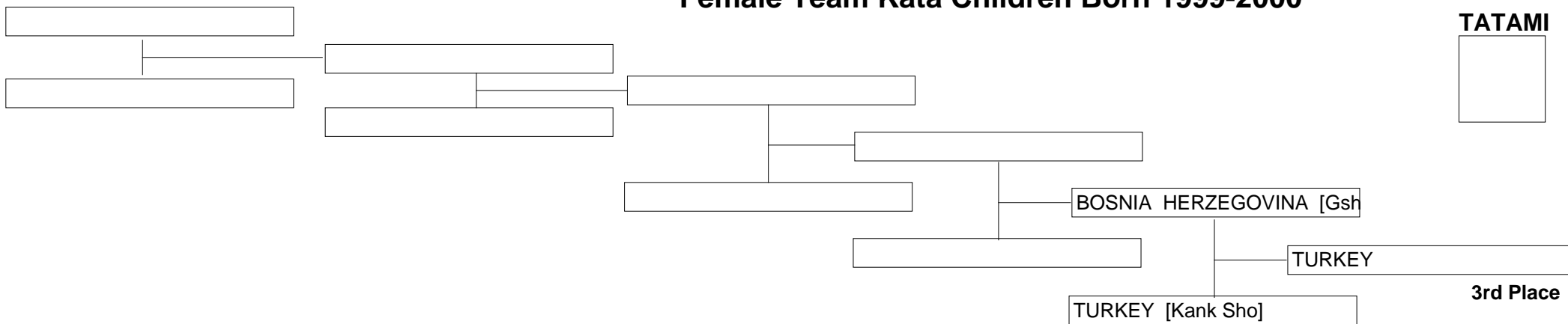



14th Balkan Cadet & Junior 3th U21 18th Children

SERBIA - Kragujevac

29/3/2013 - 31/3/2013

Female Team Kata Children Born 2001-2002

Entries: 6

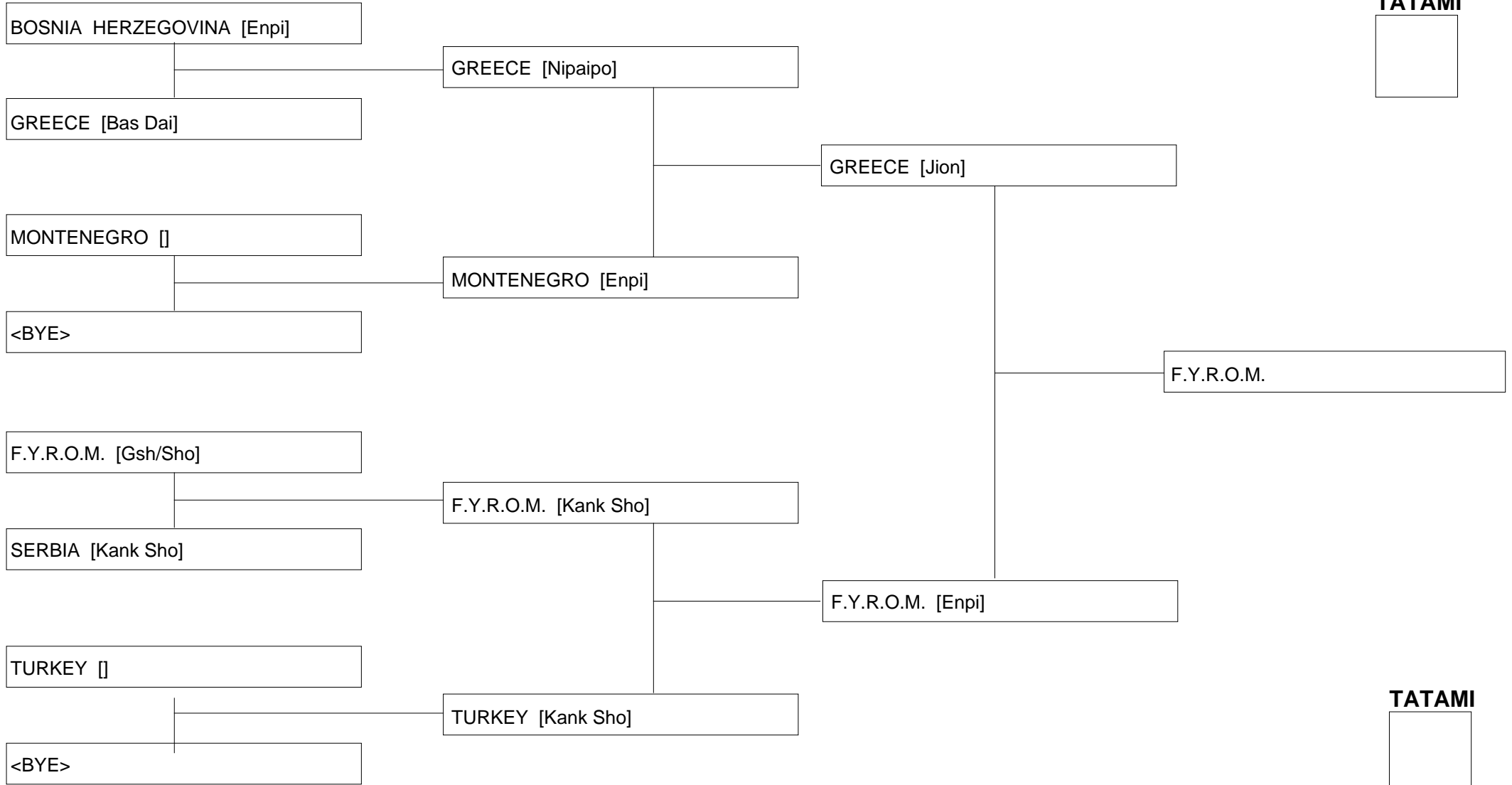

Female Team Kata Children Born 2001-2002



14th Balkan Cadet & Junior 3th U21 18th Children

SERBIA - Kragujevac

29/3/2013 - 31/3/2013

Female Team Kata Children Born 2001-2002

Repechage Pool 1

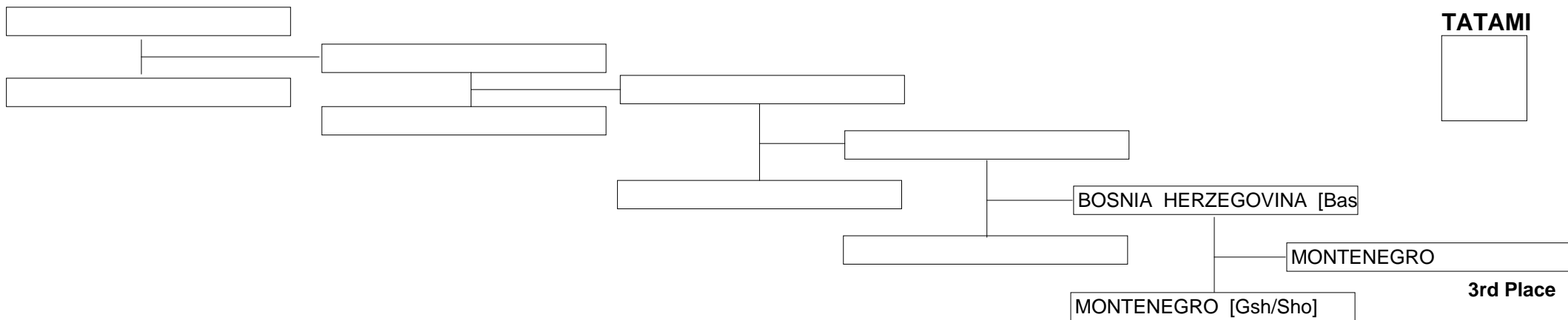

Repechage Pool 2

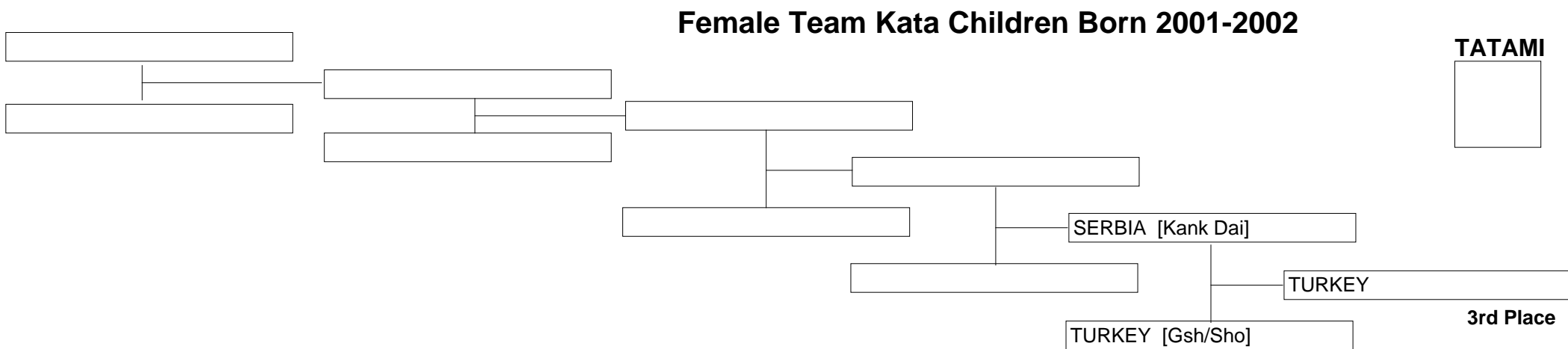



14th Balkan Cadet & Junior 3th U21 18th Children

SERBIA - Kragujevac

29/3/2013 - 31/3/2013

Male Children Born 1999 70+kg

Entries: 15



Male Children Born 1999 70+kg



14th Balkan Cadet & Junior 3th U21 18th Children

SERBIA - Kragujevac

29/3/2013 - 31/3/2013

Male Children Born 1999 70+kg

Repechage Pool 1

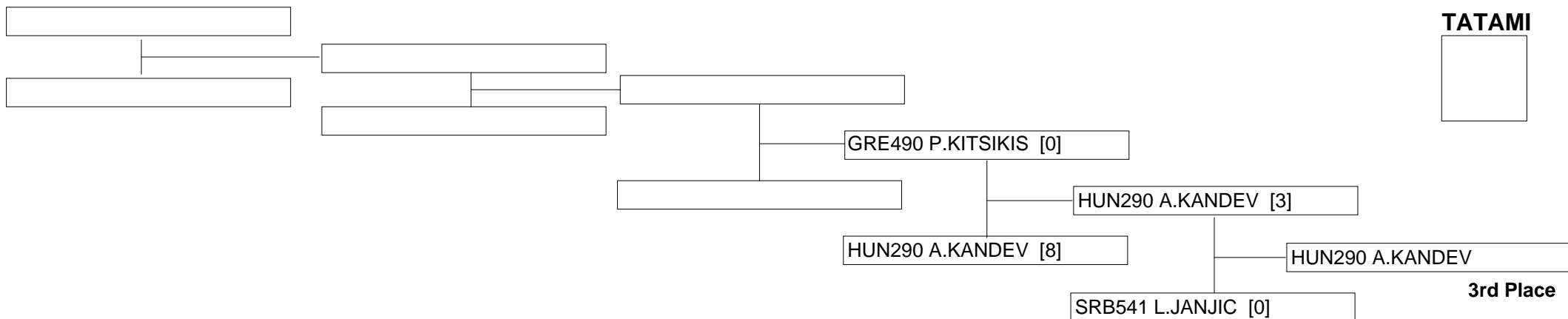

Repechage Pool 2

Male Children Born 1999 70+kg

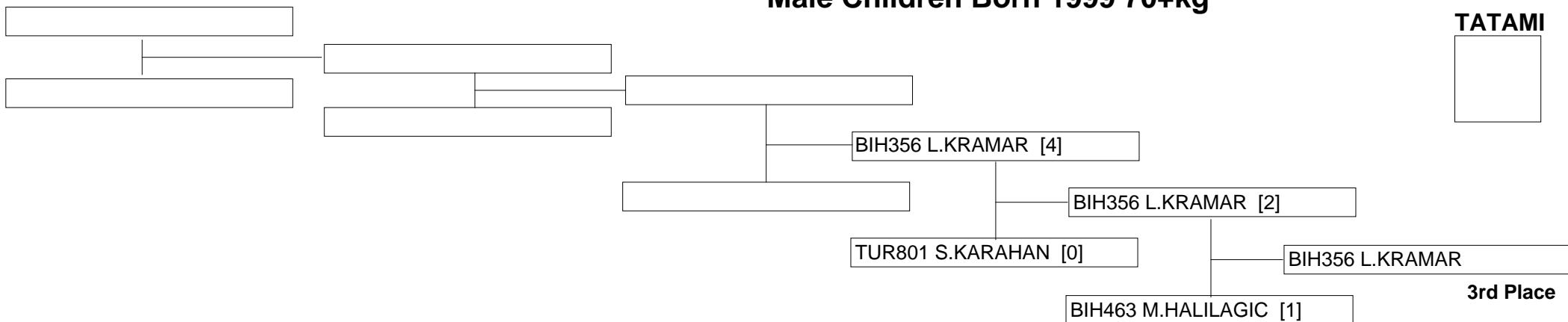



14th Balkan Cadet & Junior 3th U21 18th Children

SERBIA - Kragujevac

29/3/2013 - 31/3/2013

Male Children Born 1999 -52kg

Entries: 28

BIH388 N.FATKIC [3]
TUR789 F.ERSIN [4]
BUL251 V.PAVLOV [5]
ALB155 B.BASHA [15]
CRO355 D.BAJDE []
MNE336 R.RADOSAVOVIC []
FYR531 A.TRENDAFILOSKI []
<BYE>
HUN267 M.OSI [0]
BIH387 H.DZAFEROVIC [1]
GRE546 A.CHALKIAS [1]
SRB269 V.LAPCEVIC [4]
MNE240 M.PEKOVIC [8]
BUL235 V.RIVOV [0]
CYR324 S.PETRIDIS []
<BYE>
FYR422 S.TRAJKOSKI [3]
HUN306 Z.GULYAS [0]
CRO383 B.DREMPEPETIC []
BIH427 F.SIJERCIC []
SRB548 S.RADULOVIC [0]
BUL259 P.BOROVINOV [8]
GRE748 N.PAPADIMITRIOU []
<BYE>
HUN321 P.FEHER [1]
ALB178 A.POLLOZHANI [0]
FYR411 I.MEHAZI [0]
TUR825 M.YILDIZ [8]
MNE275 L.CVIJOVIC [1]
SRB526 D.TESANOVIC [2]
GRE588 S.TRIANTAFYLLIDIS
<BYE>





14th Balkan Cadet & Junior 3th U21 18th Children

SERBIA - Kragujevac

29/3/2013 - 31/3/2013

Male Children Born 1999 -52kg

Repechage Pool 1

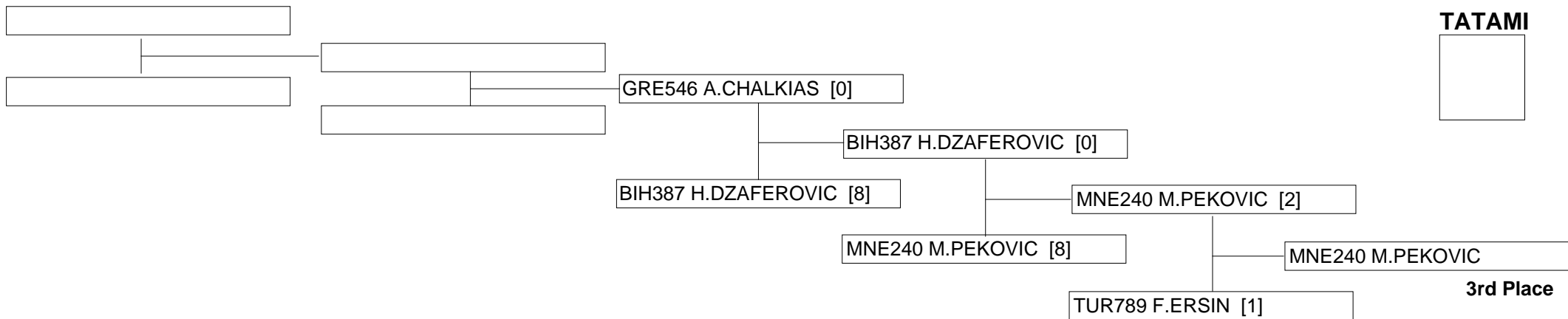

Repechage Pool 2

Male Children Born 1999 -52kg

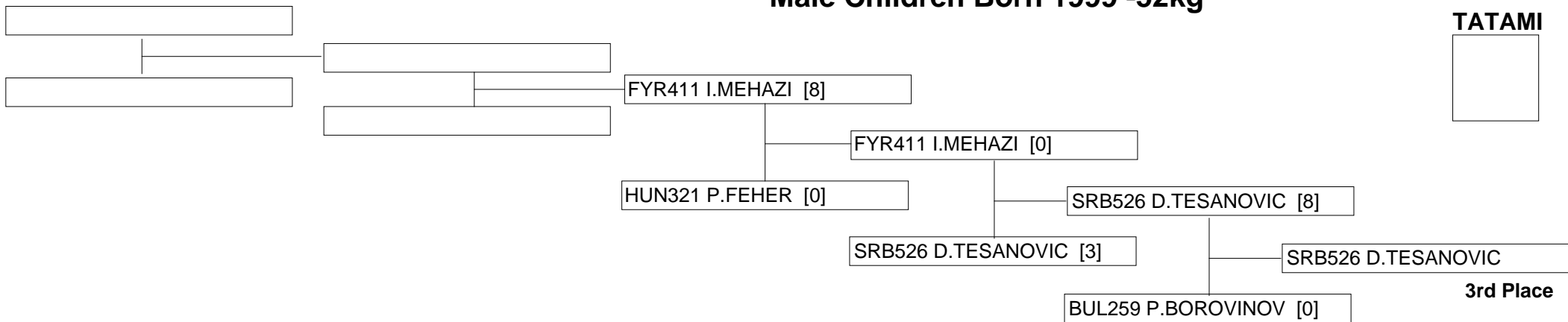



14th Balkan Cadet & Junior 3th U21 18th Children

SERBIA - Kragujevac

29/3/2013 - 31/3/2013

SRB478 A.KUDRA [0]
TUR808 Y.ONAT [8]
MNE274 M.ADZIC []
<BYE>
CYR245 C.IOANNOU [8]
BIH403 P.VUJEVIC [0]
FYR312 F.AGUSI []
<BYE>
MNE277 A.SUSKAVCEVIC [0]
HUN312 M.KNIRSCH [3]
GRE364 A.KOGIAS []
<BYE>
BUL328 E.TASKOV []
<BYE>
FYR448 S.TODOROVSKI []
<BYE>
BUL243 N.DINOLOV [0]
MNE281 P.JOKIC [3]
FYR509 A.MAHMUTI []
<BYE>
BIH482 K.KOLOBARIC [0]
GRE390 V.LAPPAS [2]
SRB509 U.REPAC []
<BYE>
TUR790 A.ESSIZ [5]
GRE534 I.VOULGAROPOULO
BIH456 D.BRANKOVIC []
<BYE>
SRB395 S.VELICKOVIC []
<BYE>
BUL316 G.NICKOLOV []
<BYE>



Entries: 22

Pool 1

TATAMI

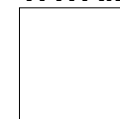

TATAMI

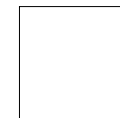

Pool 2



14th Balkan Cadet & Junior 3th U21 18th Children

SERBIA - Kragujevac

29/3/2013 - 31/3/2013

Male Children Born 1999 -57kg

Repechage Pool 1

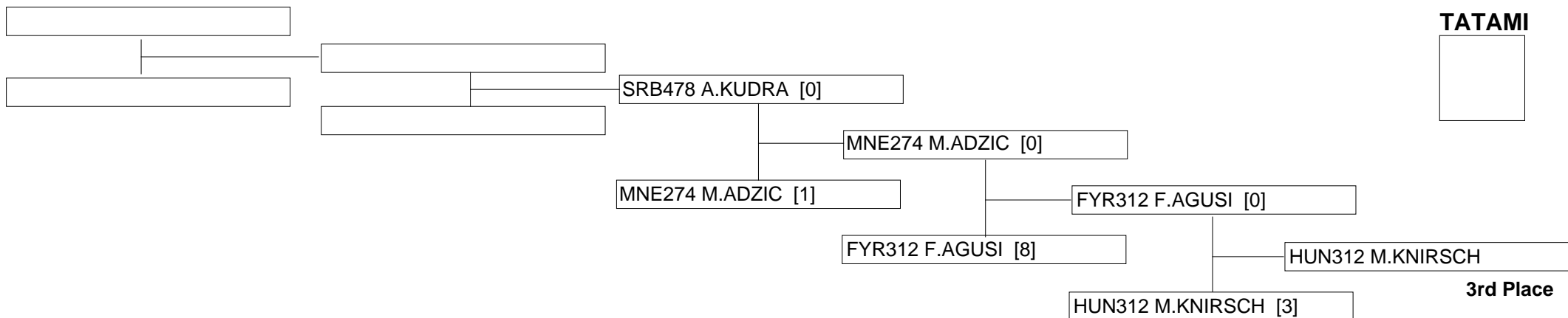

Repechage Pool 2

Male Children Born 1999 -57kg

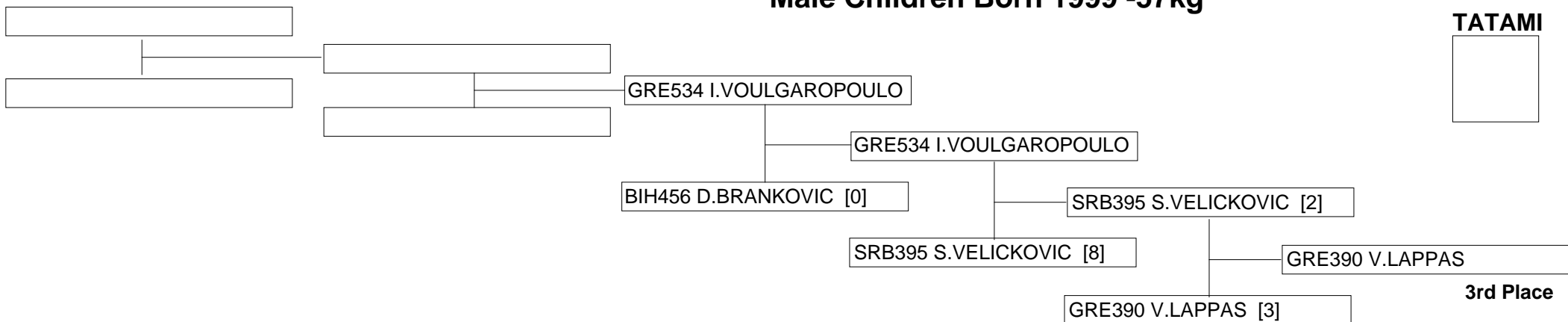



14th Balkan Cadet & Junior 3th U21 18th Children

SERBIA - Kragujevac

29/3/2013 - 31/3/2013

GRE389 A.STEFANOPOULOS
TUR776 M.CANKUL [8]
FYR371 R.LJUTVIJU []
<BYE>
CYR282 K.ANDREOU []
<BYE>
SRB502 M.POPADIC []
<BYE>
BIH458 T.CAZINKIC [2]
FYR507 D.KUZMANOVSKI [0]
GRE746 S.PANOU []
<BYE>
SRB464 Z.JOVANOVIC []
<BYE>
MNE242 E.DELJANIN []
<BYE>
MNE283 P.SMOLOVIC [0]
BIH459 A.CEHIC [6]
TUR778 S.CAYIRLI []
<BYE>
FYR519 F.POTKONJAK []
<BYE>
BUL356 V.GEORGIEV []
<BYE>
GRE757 N.SINODIAS []
<BYE>
BIH382 A.CEMAN []
<BYE>
SRB472 O.KNEZEVIC []
<BYE>
MNE332 I.BAJCETA []
<BYE>

TUR776 M.CANKUL [4]
TUR776 M.CANKUL [1]
FYR371 R.LJUTVIJU [3]
CYR282 K.ANDREOU [1]
SRB502 M.POPADIC [0]
SRB502 M.POPADIC [2]
BIH458 T.CAZINKIC [0]
GRE746 S.PANOU [4]
GRE746 S.PANOU [5]
SRB464 Z.JOVANOVIC [4]
SRB464 Z.JOVANOVIC [0]
MNE242 E.DELJANIN [0]
BIH459 A.CEHIC [2]
BIH459 A.CEHIC [4]
TUR778 S.CAYIRLI [0]
FYR519 F.POTKONJAK [8]
FYR519 F.POTKONJAK [0]
BUL356 V.GEORGIEV [0]
GRE757 N.SINODIAS [0]
BIH382 A.CEMAN [5]
BIH382 A.CEMAN [8]
SRB472 O.KNEZEVIC [2]
MNE332 I.BAJCETA [0]
MNE332 I.BAJCETA [3]

Male Children Born 1999 -63kg

Entries: 19

Pool 1

TATAMI



TATAMI



Pool 2

Male Children Born 1999 -63kg



14th Balkan Cadet & Junior 3th U21 18th Children

SERBIA - Kragujevac

29/3/2013 - 31/3/2013

Male Children Born 1999 -63kg

Repechage Pool 1

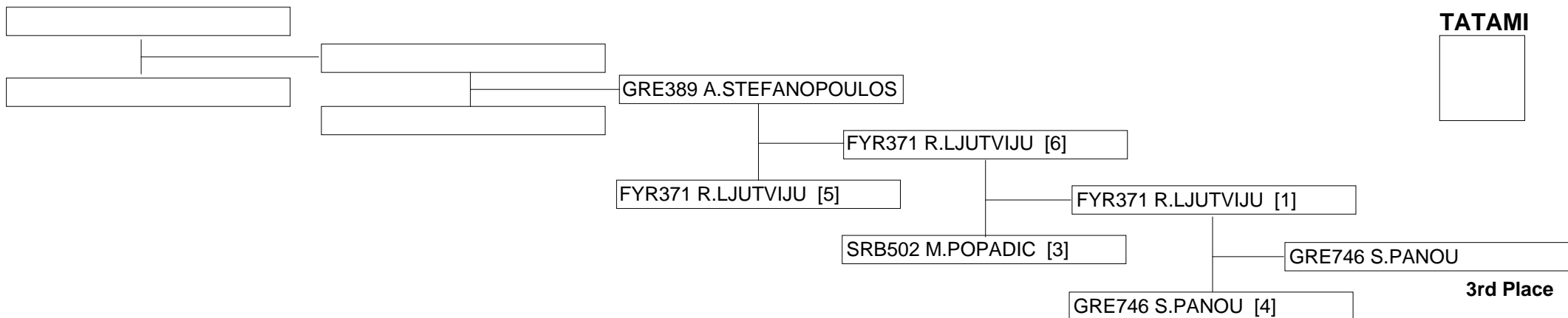

Repechage Pool 2

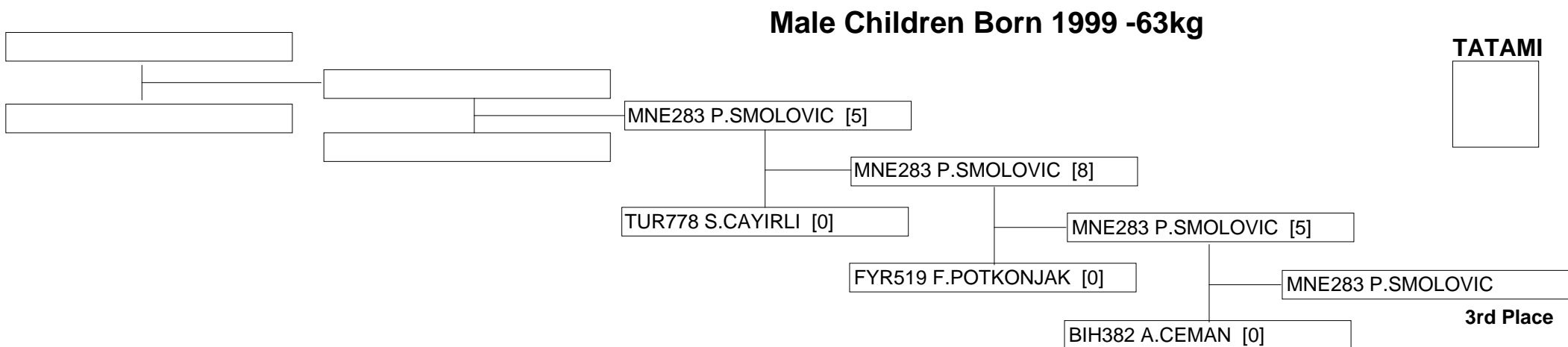



14th Balkan Cadet & Junior 3th U21 18th Children

SERBIA - Kragujevac

29/3/2013 - 31/3/2013

BUL301 B.BEDRY [8]
MNE366 L.VULETIC [0]
GRE765 A.VATHIS []
<BYE>
FYR399 S.MERIPUSHKOSKI []
<BYE>
BIH441 A.NEZIREVIC []
<BYE>
BIH525 I.VUKOJA [8]
BUL271 S.MUSTAFA [0]
TUR685 M.ULASLI []
<BYE>
CRO407 A.JURCIC []
<BYE>
SRB533 M.VUKOVIC []
<BYE>
CYR329 A.ELEFTHERIOU [0]
SRB325 N.SINKO [7]
BIH548 D.SIMIC []
<BYE>
MNE196 M.DROBNJAK []
<BYE>
GRE715 S.ILIOPOULOS []
<BYE>
GRE724 E.KIRATLIDIS [5]
BUL318 S.PASKALEV [1]
FYR501 A.JAJI []
<BYE>
SRB539 J.BECIRIC []
<BYE>
TUR783 Y.DONMEZ []
<BYE>

BUL301 B.BEDRY [6]
BUL301 B.BEDRY [2]
GRE765 A.VATHIS [2]
FYR399 S.MERIPUSHKOSKI []
BIH441 A.NEZIREVIC [5]
BIH441 A.NEZIREVIC [4]
BIH525 I.VUKOJA [1]
BIH525 I.VUKOJA [3]
TUR685 M.ULASLI [0]
BIH525 I.VUKOJA [8]
CRO407 A.JURCIC [2]
CRO407 A.JURCIC [1]
SRB533 M.VUKOVIC [0]
SRB325 N.SINKO [8]
SRB325 N.SINKO [4]
BIH548 D.SIMIC [0]
SRB325 N.SINKO [0]
MNE196 M.DROBNJAK [3]
MNE196 M.DROBNJAK [0]
GRE715 S.ILIOPOULOS [2]
GRE724 E.KIRATLIDIS [1]
FYR501 A.JAJI [0]
FYR501 A.JAJI [4]
SRB539 J.BECIRIC [0]
TUR783 Y.DONMEZ [2]
TUR783 Y.DONMEZ [4]

Male Children Born 1999 -70kg

Entries: 20

Pool 1

TATAMI

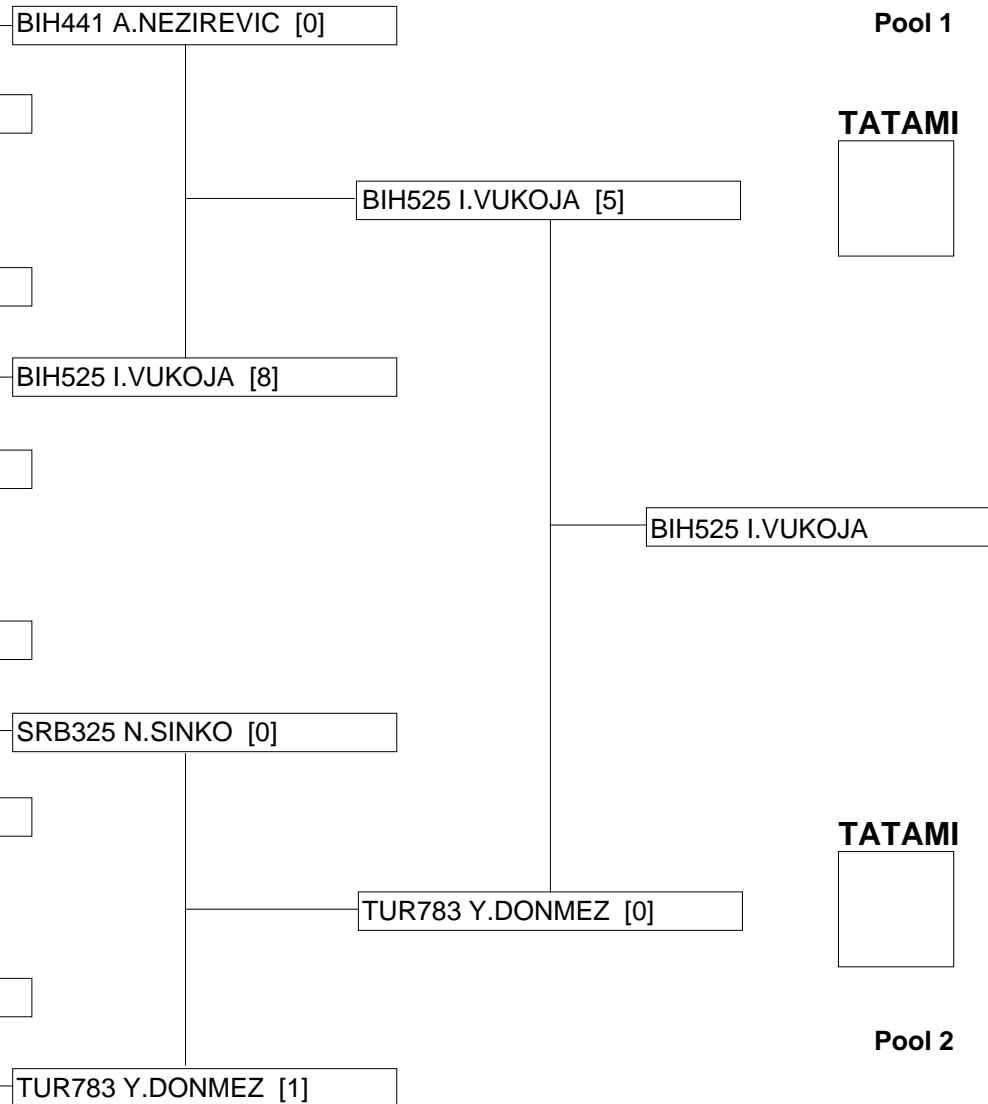

Male Children Born 1999 -70kg

Pool 2

TATAMI

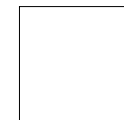



14th Balkan Cadet & Junior 3th U21 18th Children

SERBIA - Kragujevac

29/3/2013 - 31/3/2013

Male Children Born 1999 -70kg

Repechage Pool 1

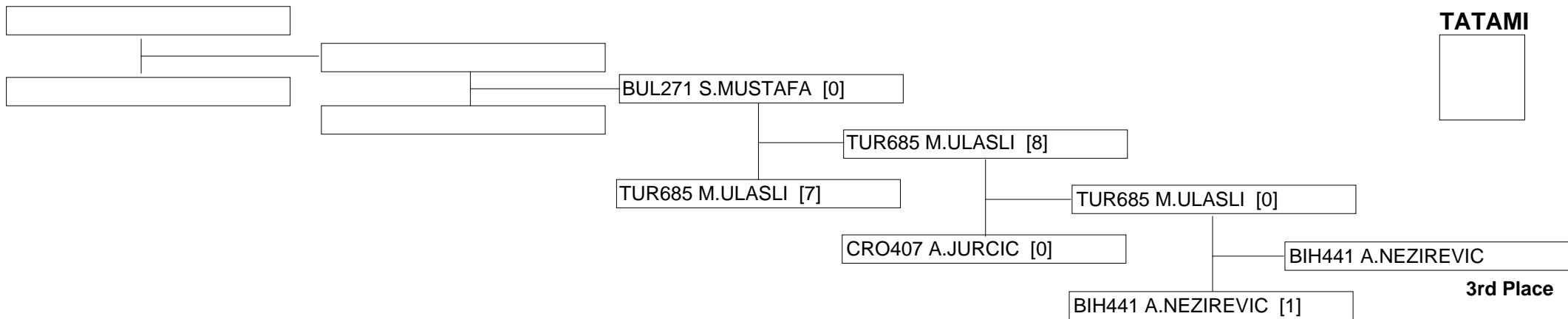

Repechage Pool 2

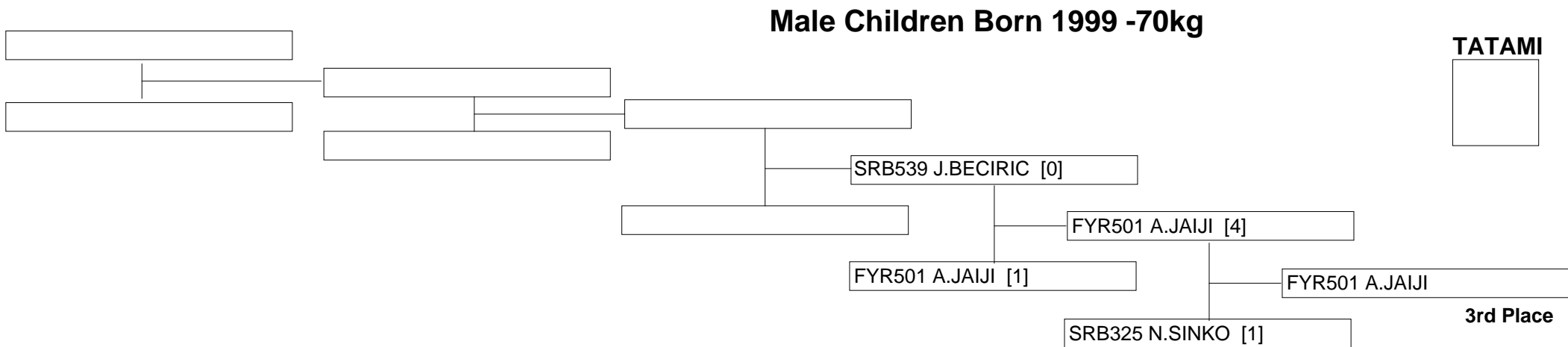



14th Balkan Cadet & Junior 3th U21 18th Children

SERBIA - Kragujevac

29/3/2013 - 31/3/2013

Male Children Born 2000 55+kg

Entries: 21

CYR312 A.PELETEOS [0]
BUL325 A.SPIROV [8]
SRB451 A.CVETKOVIC []
<BYE>
HUN295 J.PAP [0]
FYR410 M.KOSTOV [8]
BIH518 N.SUKRIJA []
<BYE>
GRE472 G.KAPPAS [0]
SRB476 L.KRSTIC [4]
BUL323 M.RINKOV []
<BYE>
BIH452 Z.BAHTANOVIC []
<BYE>
TUR802 F.KAYALI []
<BYE>
BUL362 K.KALINKOV [0]
FYR381 F.NESTOROVSKI [3]
TUR822 M.ULASLI []
<BYE>
GRE725 I.KLEISSAS []
<BYE>
MNE355 N.POPOVIC []
<BYE>
GRE727 V.KONTOGIANNIS [0]
SRB355 M.NONKOVIC [3]
CYR261 G.ANDREOU []
<BYE>
HUN264 D.CSATO []
<BYE>
BIH563 A.DRAGICEVIC []
<BYE>

BUL325 A.SPIROV [2]
SRB451 A.CVETKOVIC [0]
SRB451 A.CVETKOVIC [3]
FYR410 M.KOSTOV [8]
FYR410 M.KOSTOV [8]
BIH518 N.SUKRIJA [0]
SRB476 L.KRSTIC [2]
SRB476 L.KRSTIC [0]
BUL323 M.RINKOV [0]
BIH452 Z.BAHTANOVIC [0]
TUR802 F.KAYALI [8]
TUR802 F.KAYALI [8]
FYR381 F.NESTOROVSKI [8]
FYR381 F.NESTOROVSKI [3]
TUR822 M.ULASLI [0]
GRE725 I.KLEISSAS [6]
GRE725 I.KLEISSAS [0]
MNE355 N.POPOVIC [0]
SRB355 M.NONKOVIC [3]
SRB355 M.NONKOVIC [1]
CYR261 G.ANDREOU [0]
HUN264 D.CSATO [5]
HUN264 D.CSATO [0]
BIH563 A.DRAGICEVIC [0]



Pool 1

TATAMI



TATAMI

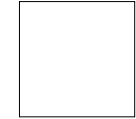

Pool 2

Male Children Born 2000 55+kg



14th Balkan Cadet & Junior 3th U21 18th Children

SERBIA - Kragujevac

29/3/2013 - 31/3/2013

Male Children Born 2000 55+kg

Repechage Pool 1

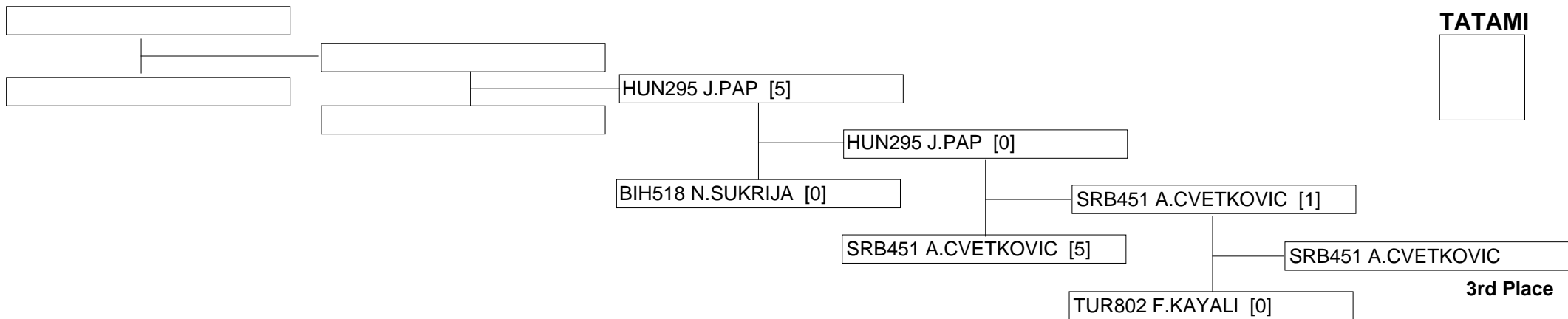

Repechage Pool 2

Male Children Born 2000 55+kg

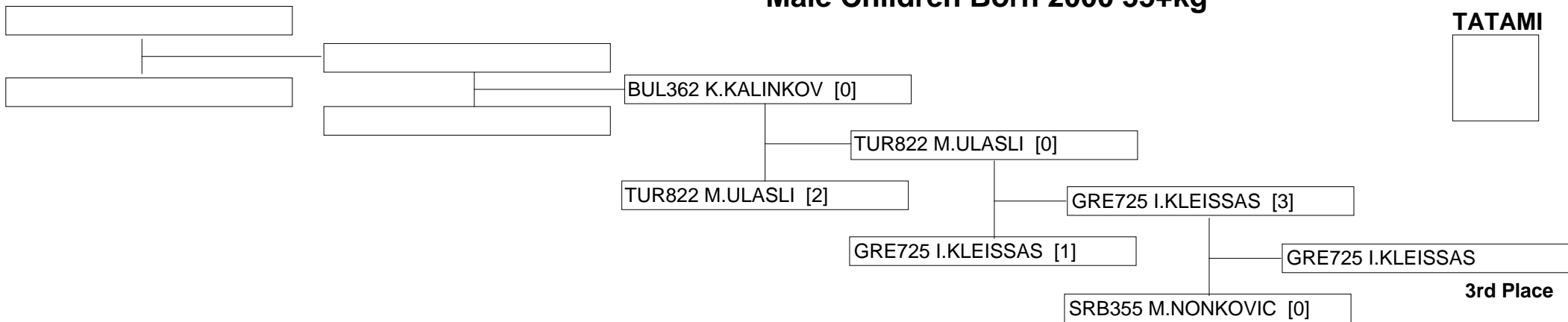



14th Balkan Cadet & Junior 3th U21 18th Children

SERBIA - Kragujevac

29/3/2013 - 31/3/2013

Male Children Born 2000 -40kg

Entries: 23

BIH557 H.VEJO [2]
GRE698 I.BOUKAS [1]
HUN253 D.NICHOLS []
<BYE>

BIH557 H.VEJO [3]
HUN253 D.NICHOLS [3]
HUN253 D.NICHOLS [6]

SRB372 D.VRUCINIC [8]
BUL331 K.VELINOV [3]

SRB372 D.VRUCINIC [4]
SRB372 D.VRUCINIC [6]

FYR468 D.BAKIJA []
<BYE>

FYR468 D.BAKIJA [0]

SRB503 D.POPOVIC [0]
TUR809 O.OZUCAR [1]

TUR809 O.OZUCAR [1]
TUR809 O.OZUCAR [2]

GRE521 C.XENOS []
<BYE>

GRE521 C.XENOS [0]

MNE296 J.CIROVIC [0]
BUL379 K.VASILEV [8]

BUL379 K.VASILEV [6]
BUL379 K.VASILEV [0]

FYR372 U.BAJRAMI []
<BYE>

FYR372 U.BAJRAMI [4]

FYR404 S.BEQIRI [2]
SRB400 D.MISOVIC [3]

SRB400 D.MISOVIC [0]
BIH350 A.HUREM [2]

BIH350 A.HUREM []
<BYE>

BIH350 A.HUREM [2]

TUR763 S.ALICI [5]
CYR310 S.PARPOUNAS [0]

TUR763 S.ALICI [2]
TUR763 S.ALICI [0]

HUN275 A.GULYAS []
<BYE>

HUN275 A.GULYAS [0]

BIH412 L.KORAC [6]
BUL309 T.KITANOV [0]

BIH412 L.KORAC [0]
GRE691 G.AVRAMIDIS [2]

GRE691 G.AVRAMIDIS []
<BYE>

GRE691 G.AVRAMIDIS [4]

ALB165 F.KURTI []
<BYE>

ALB165 F.KURTI [0]
HUN234 B.VECSEI [1]
HUN234 B.VECSEI [3]

HUN234 B.VECSEI []
<BYE>

HUN234 B.VECSEI [5]

SRB372 D.VRUCINIC [0]

TUR809 O.OZUCAR [8]

TUR809 O.OZUCAR [5]

TUR809 O.OZUCAR

BIH350 A.HUREM [3]

BIH350 A.HUREM [0]

Male Children Born 2000 -40kg

Pool 1

TATAMI



TATAMI

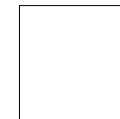

Pool 2



14th Balkan Cadet & Junior 3th U21 18th Children

SERBIA - Kragujevac

29/3/2013 - 31/3/2013

Male Children Born 2000 -40kg

Repechage Pool 1

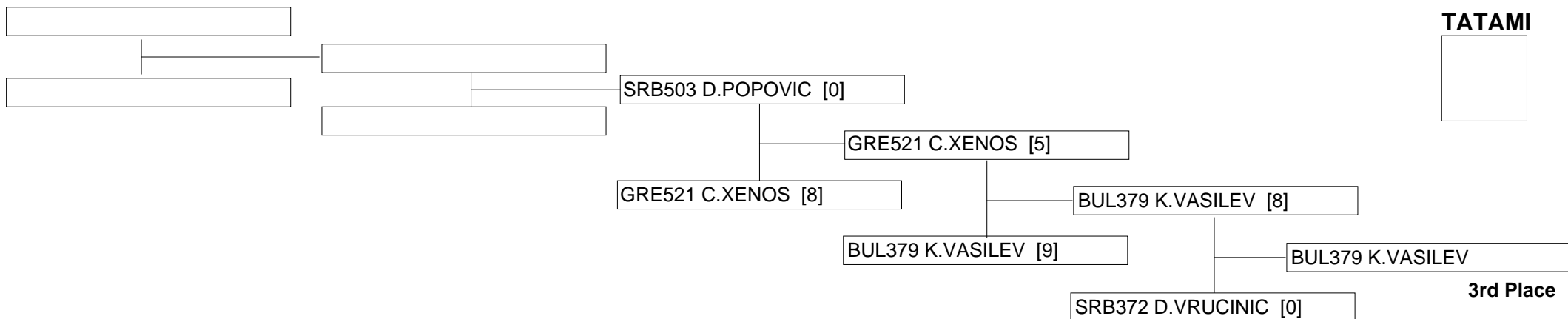

Repechage Pool 2

Male Children Born 2000 -40kg

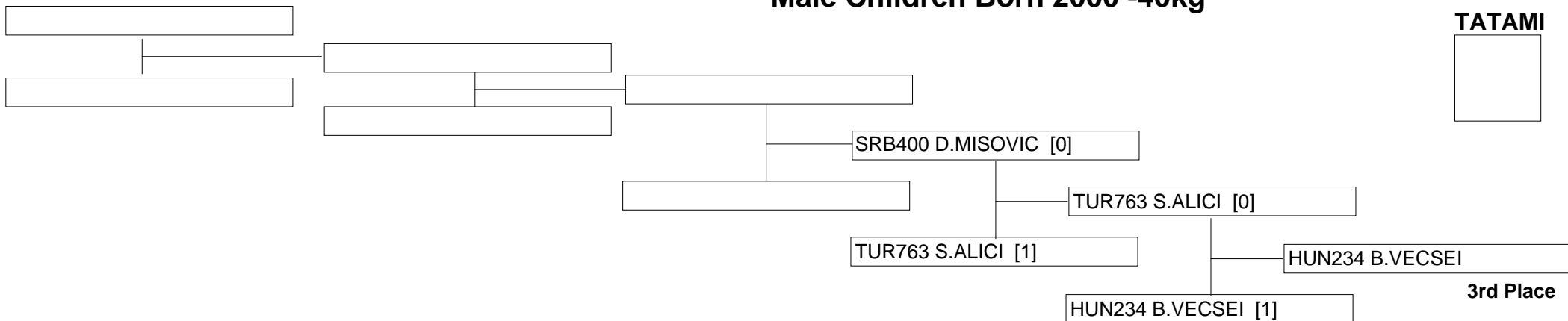



14th Balkan Cadet & Junior 3th U21 18th Children

SERBIA - Kragujevac

29/3/2013 - 31/3/2013

Male Children Born 2000 -45kg

Entries: 20

CYR266 O.IOANNIDES [0]
MNE329 N.SUMOVIQ [2]
BIH385 D.CUCAK []
<BYE>
TUR761 I.AKMAN []
<BYE>
SRB512 M.RISTIC []
<BYE>
FYR479 J.KURTISHI [5]
BUL360 P.IVANOV [0]
GRE487 K.MASTROGIANNIS [1]
<BYE>
SRB504 N.RAC []
<BYE>
BIH534 L.BONCA []
<BYE>
BUL329 S.TSANOV [5]
MNE377 A.KOMNENOVIC [1]
TUR787 M.EMER []
<BYE>
BIH345 R.COLO []
<BYE>
GRE495 A.BATIS []
<BYE>
CYR267 A.THEODOSIOU [3]
BUL354 P.EFTIMOV [0]
FYR405 O.JAMINI []
<BYE>
GRE478 T.SKOUFIAS [1]
<BYE>
SRB487 N.MARKOVIC [1]
<BYE>



Male Children Born 2000 -45kg



14th Balkan Cadet & Junior 3th U21 18th Children

SERBIA - Kragujevac

29/3/2013 - 31/3/2013

Male Children Born 2000 -45kg

Repechage Pool 1

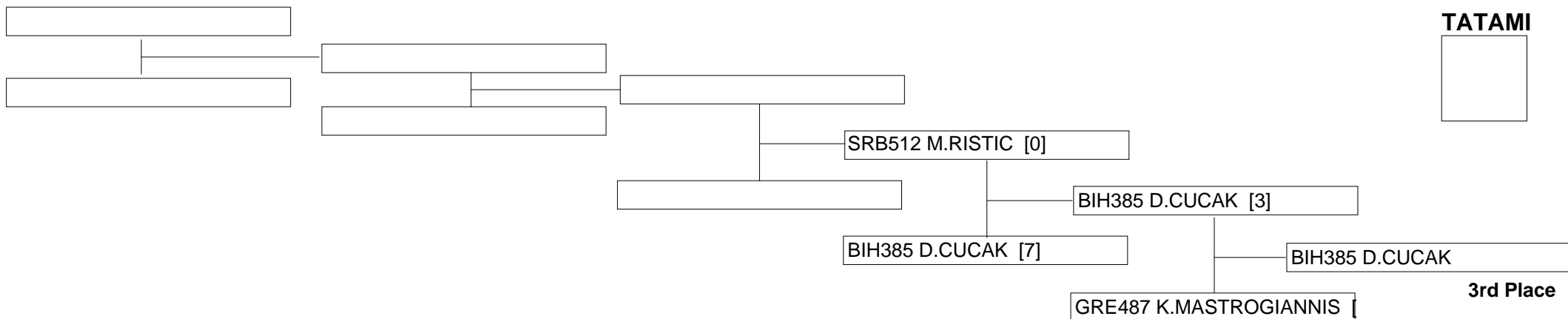

Repechage Pool 2

Male Children Born 2000 -45kg

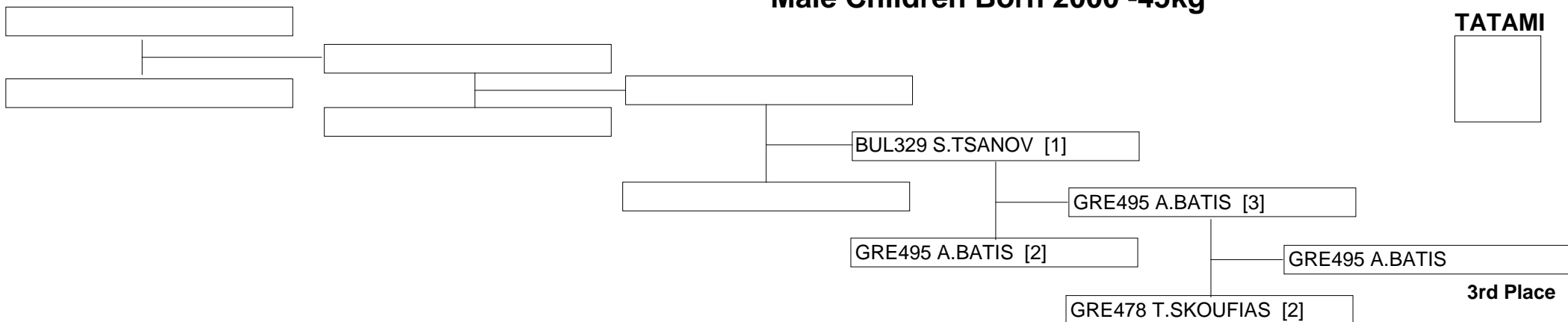



14th Balkan Cadet & Junior 3th U21 18th Children

SERBIA - Kragujevac

29/3/2013 - 31/3/2013

SRB540 U.BOZANIC [0]
CRO389 B.PETROVIC [6]
BIH562 D.FALETAR []
<BYE>
MNE409 F.BRNOVIC []
<BYE>
GRE745 A.ORTOULIDIS []
<BYE>
TUR768 O.ATES [8]
FYR499 R.GOCHEV [0]
GRE714 C.GOTSIS []
<BYE>
BIH393 A.MATIC []
<BYE>
SRB450 J.CIRIC []
<BYE>
SRB364 N.SIMEUNOVIC [1]
GRE601 I.KOURLIAFTIS [2]
MNE264 S.TAHIROVIC []
<BYE>
FYR424 V.XHABIRI []
<BYE>
BIH340 N.BEKTAS []
<BYE>
FYR368 D.GULABOSKI [0]
CYR269 A.VICTOROS [7]
BUL372 T.RANCHEV []
<BYE>
HUN262 M.FALUSI []
<BYE>
TUR792 S.GOK []
<BYE>

CRO389 B.PETROVIC [1]
BIH562 D.FALETAR [0]
MNE409 F.BRNOVIC [0]
GRE745 A.ORTOULIDIS [4]
TUR768 O.ATES [8]
GRE714 C.GOTSIS [0]
BIH393 A.MATIC [0]
SRB450 J.CIRIC [2]
GRE601 I.KOURLIAFTIS [5]
MNE264 S.TAHIROVIC [0]
FYR424 V.XHABIRI [0]
BIH340 N.BEKTAS [5]
CYR269 A.VICTOROS [8]
BUL372 T.RANCHEV [0]
HUN262 M.FALUSI [0]
TUR792 S.GOK [6]

CRO389 B.PETROVIC [8]
GRE745 A.ORTOULIDIS [0]
TUR768 O.ATES [0]
SRB450 J.CIRIC [2]
GRE601 I.KOURLIAFTIS [0]
BIH340 N.BEKTAS [8]
CYR269 A.VICTOROS [1]
TUR792 S.GOK [7]

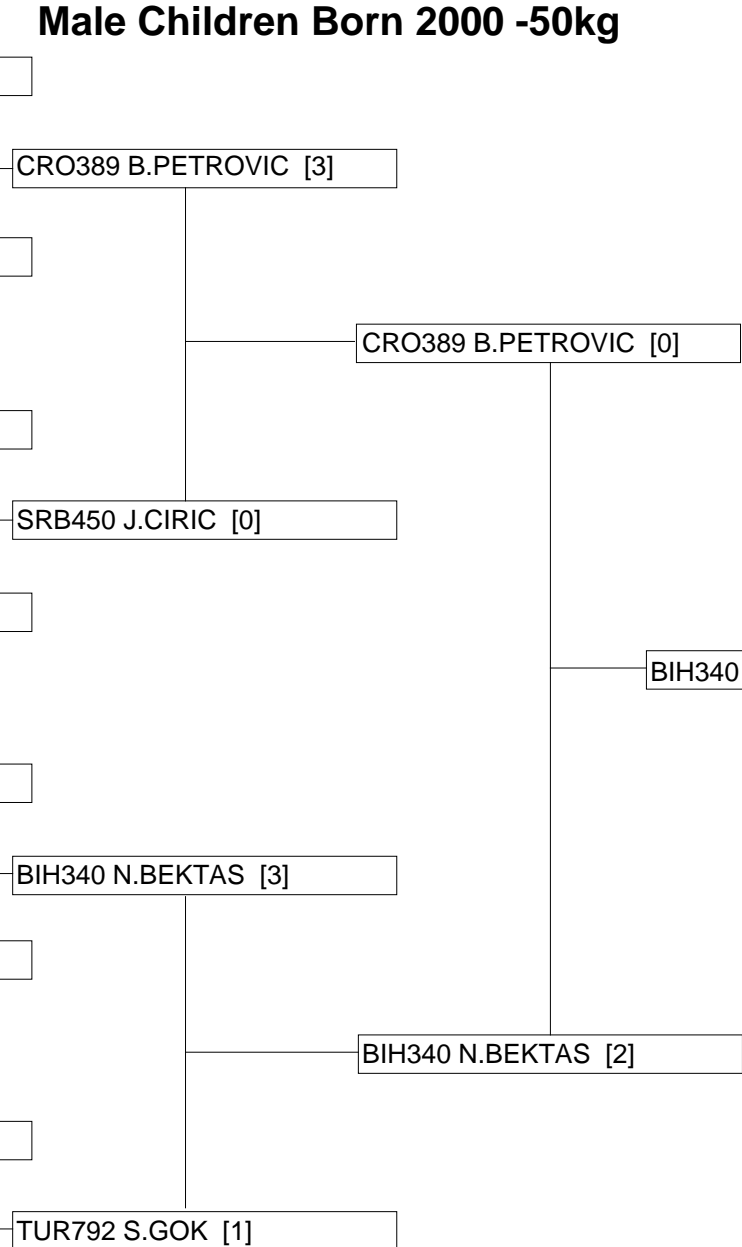

Male Children Born 2000 -50kg

Entries: 20

Pool 1

TATAMI

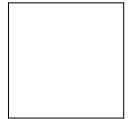

TATAMI

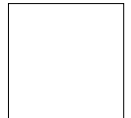

Pool 2

Male Children Born 2000 -50kg



14th Balkan Cadet & Junior 3th U21 18th Children

SERBIA - Kragujevac

29/3/2013 - 31/3/2013

Male Children Born 2000 -50kg

Repechage Pool 1

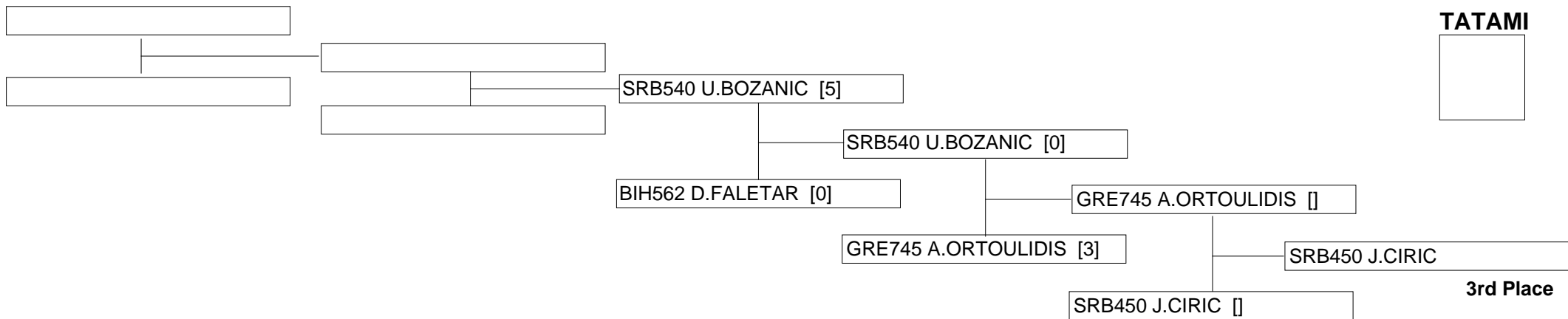

Repechage Pool 2

Male Children Born 2000 -50kg

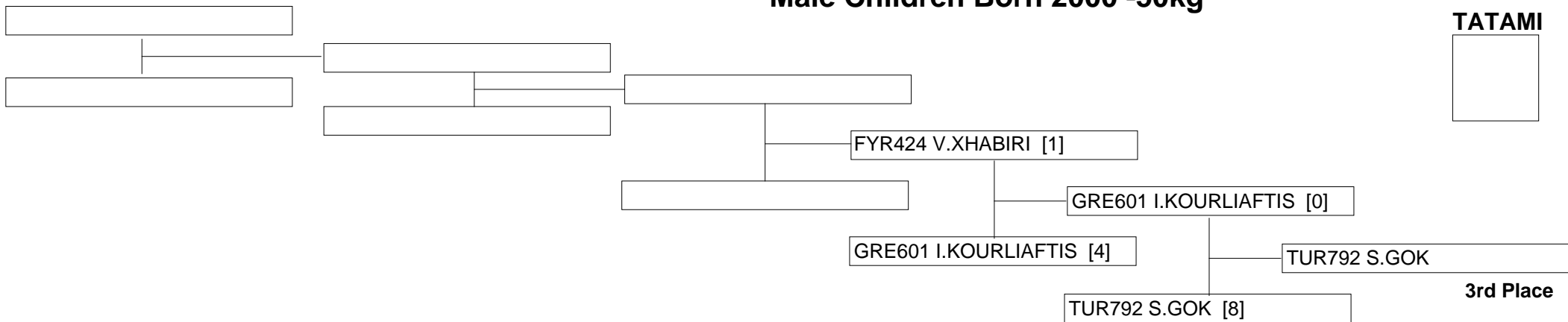



14th Balkan Cadet & Junior 3th U21 18th Children

SERBIA - Kragujevac

29/3/2013 - 31/3/2013

Male Children Born 2000 -55kg

Entries: 18

BIH380 A.ZAHIROVIC [4]
MNE399 V.MARKOVIC [1]
TUR669 H.KOC []
<BYE>
SRB491 V.MRDJA []
<BYE>
GRE568 G.MALANDRAKIS []
<BYE>
MNE345 P.IVANOVIC []
<BYE>
GRE470 K.LITOS []
<BYE>
BIH480 B.KARIC []
<BYE>
SRB447 N.BOJCIC []
<BYE>
GRE513 D.RIGAS [1]
HUN261 R.GYOVAI [0]
TUR640 O.ARSLAN []
<BYE>
SRB481 D.LETIC []
<BYE>
CYR258 A.LOUIS []
<BYE>
TUR767 O.ASLAN []
<BYE>
BIH343 H.CAJIC []
<BYE>
MNE349 D.MEDENICA []
<BYE>
FYR503 F.JANCOVSKI []
<BYE>



Pool 1

TATAMI



TATAMI

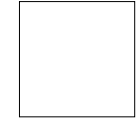

Pool 2

Male Children Born 2000 -55kg



14th Balkan Cadet & Junior 3th U21 18th Children

SERBIA - Kragujevac

29/3/2013 - 31/3/2013

Male Children Born 2000 -55kg

Repechage Pool 1

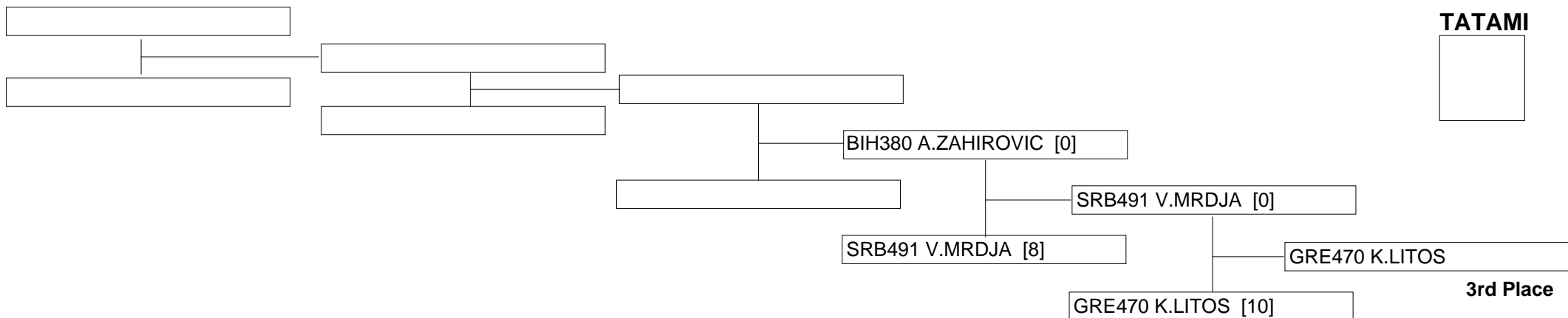

Repechage Pool 2

Male Children Born 2000 -55kg

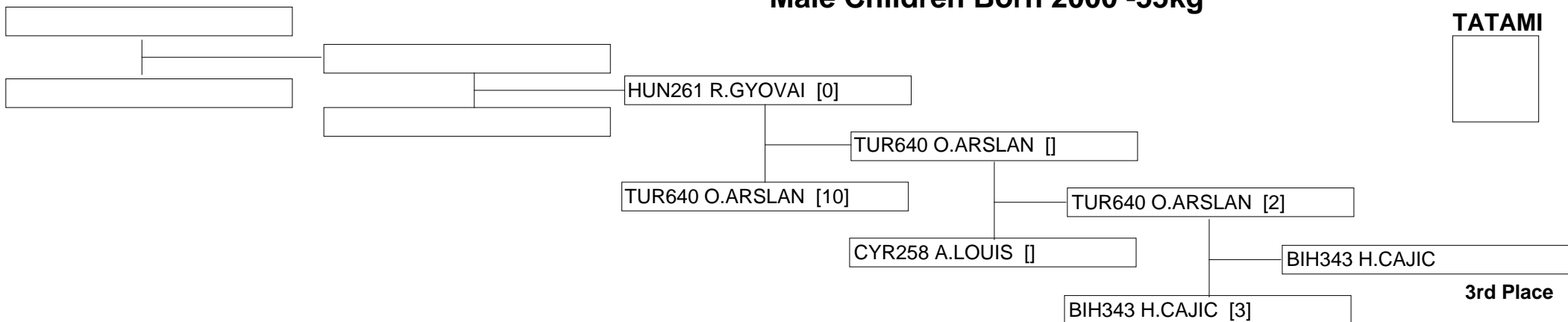



14th Balkan Cadet & Junior 3th U21 18th Children

SERBIA - Kragujevac

29/3/2013 - 31/3/2013

Male Children Born 2001 50+kg

Entries: 15



Male Children Born 2001 50+kg



14th Balkan Cadet & Junior 3th U21 18th Children

SERBIA - Kragujevac

29/3/2013 - 31/3/2013

Male Children Born 2001 50+kg

Repechage Pool 1

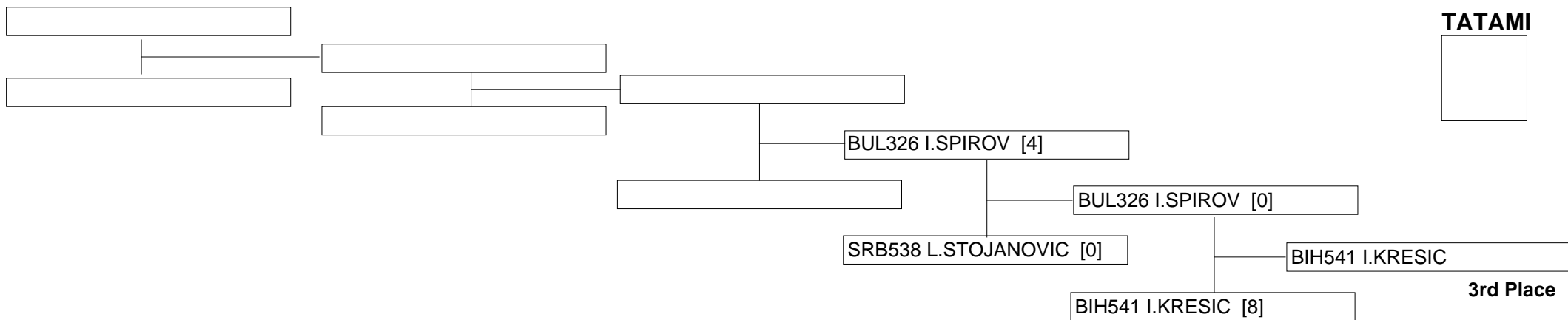

Repechage Pool 2

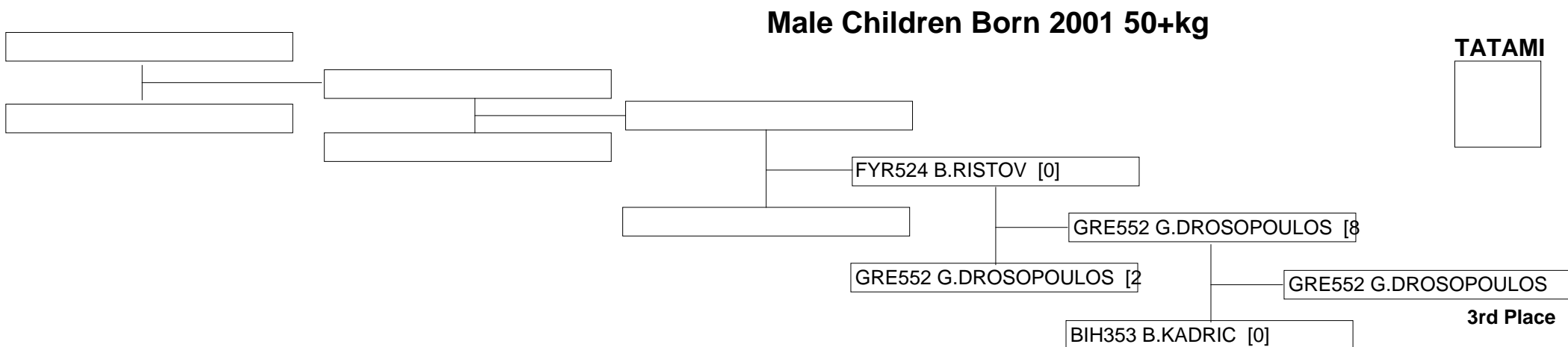



14th Balkan Cadet & Junior 3th U21 18th Children

SERBIA - Kragujevac

29/3/2013 - 31/3/2013

Entries: 24

Male Children Born 2001 -35kg

CYR317 C.THEOPEMTOU [0]
MNE354 A.POPOVIC [6]
GRE702 P.CHRISTODOULIDIS
<BYE>
FYR515 G.PETKOV [1]
BIH366 E.PESKIC [2]
SRB486 M.MARKOVIC []
<BYE>
BUL322 S.PETRUNOV [8]
ALB174 D.MECE [0]
GRE729 V.KOTZAMANIS []
<BYE>
FYR396 A.IDRIZ [3]
HUN296 D.PINTER [1]
SRB550 N.JOVANOVIC []
<BYE>
TUR806 M.OGUZ [1]
BUL298 D.ZAHARIEV [0]
MNE286 S.BAJIC []
<BYE>
SRB497 N.PETKOVIC [1]
FYR500 D.HALIMI [0]
BIH400 S.SODIC []
<BYE>
CYR196 S.NICOLAOU [3]
GRE602 I.MALEAS [0]
BIH342 S.BRANKOVIC []
<BYE>
BUL366 V.MOMCHILOV [8]
HUN293 O.MONES [0]
MNE396 R.JACOVIC []
<BYE>

MNE354 A.POPOVIC [6]
MNE354 A.POPOVIC [2]
GRE702 P.CHRISTODOULIDIS
BIH366 E.PESKIC []
SRB486 M.MARKOVIC []
BUL322 S.PETRUNOV [8]
GRE729 V.KOTZAMANIS [0]
FYR396 A.IDRIZ [9]
SRB550 N.JOVANOVIC [1]
TUR806 M.OGUZ [9]
MNE286 S.BAJIC [0]
SRB497 N.PETKOVIC [8]
BIH400 S.SODIC [0]
CYR196 S.NICOLAOU [0]
BIH342 S.BRANKOVIC [3]
BUL366 V.MOMCHILOV [5]
MNE396 R.JACOVIC [4]

MNE354 A.POPOVIC [2]
BIH366 E.PESKIC [1]
BUL322 S.PETRUNOV [2]
FYR396 A.IDRIZ [6]
FYR396 A.IDRIZ [3]
TUR806 M.OGUZ [7]
SRB497 N.PETKOVIC [0]
BIH342 S.BRANKOVIC [4]
BUL366 V.MOMCHILOV [0]

MNE354 A.POPOVIC [0]

FYR396 A.IDRIZ [3]

FYR396 A.IDRIZ [6]

FYR396 A.IDRIZ

TUR806 M.OGUZ [4]

TUR806 M.OGUZ [0]

BIH342 S.BRANKOVIC [0]

Pool 1

TATAMI

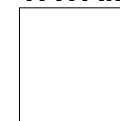

TATAMI

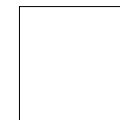

Pool 2

Male Children Born 2001 -35kg



14th Balkan Cadet & Junior 3th U21 18th Children

SERBIA - Kragujevac

29/3/2013 - 31/3/2013

Male Children Born 2001 -35kg

Repechage Pool 1

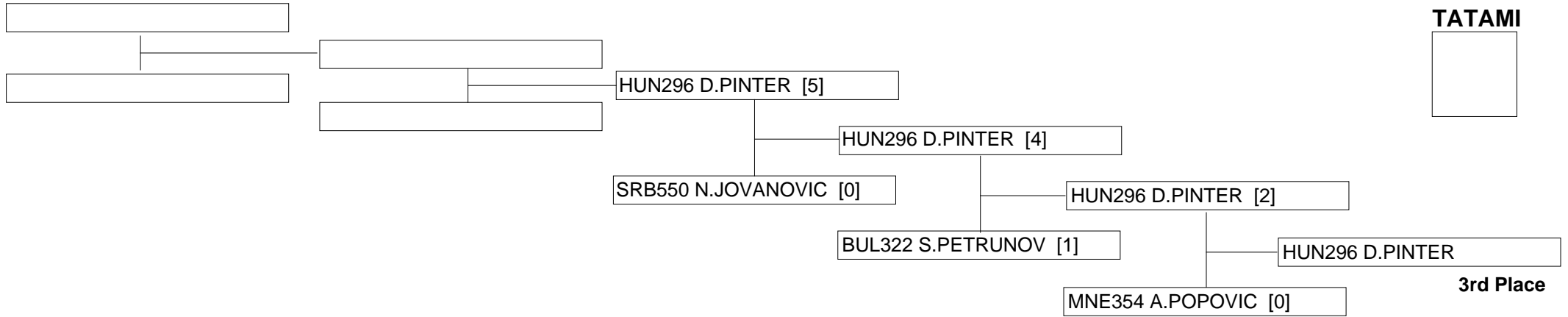

Repechage Pool 2

Male Children Born 2001 -35kg

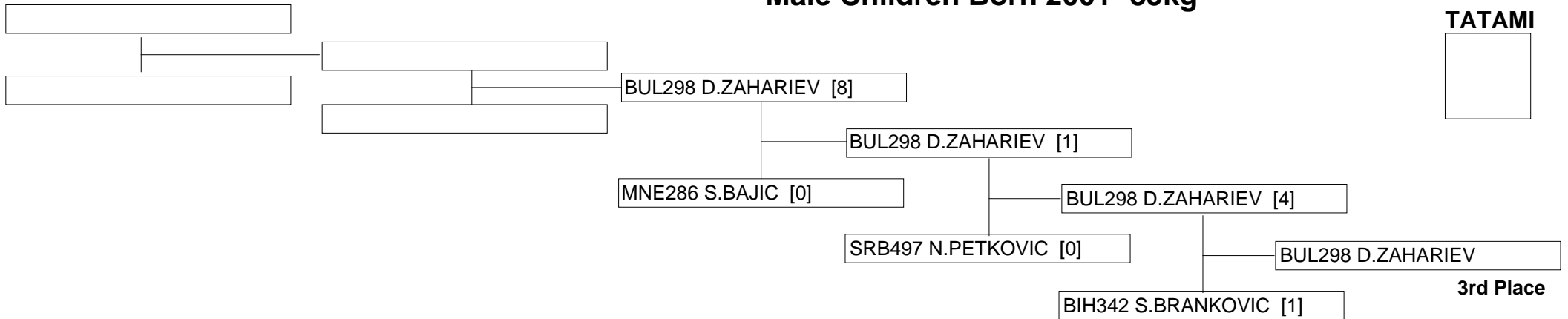



14th Balkan Cadet & Junior 3th U21 18th Children

SERBIA - Kragujevac

29/3/2013 - 31/3/2013

HUN310 B.KAPDEBO [0]
MNE350 B.MILICKOVIC [8]
CRO394 T.TOMIC [2]
TUR760 K.AGAC [0]
FYR533 F.VESALI [3]
BUL352 D.DIMITROV [0]
SRB458 L.ILIC []
<BYE>
CRO405 A.GRGIC [0]
MNE304 J.RAKOCEVIC [2]
ALB167 I.DAKU []
<BYE>
GRE557 A.KARAIKOS [0]
SRB468 L.JURISIN -KAUFMAN
BIH464 A.HAMIDOVIC []
<BYE>
MNE284 I.ZIZIC []
FYR522 D.RAMADANOVSKI []
CRO395 L.TOMLJANOVIC []
<BYE>
GRE579 A.RELIAS []
HUN271 K.BALINT []
BIH546 L.MISANOVIC []
<BYE>
BIH474 N.JELICIC []
SRB389 M.POPOVIC []
BUL341 M.ALEXOV []
<BYE>
FYR433 S.SMILKOVSKI []
ALB169 S.DURAKU []
GRE562 S.KOURNOUTIS []
<BYE>





14th Balkan Cadet & Junior 3th U21 18th Children

SERBIA - Kragujevac

29/3/2013 - 31/3/2013

Male Children Born 2001 -40kg

Repechage Pool 1

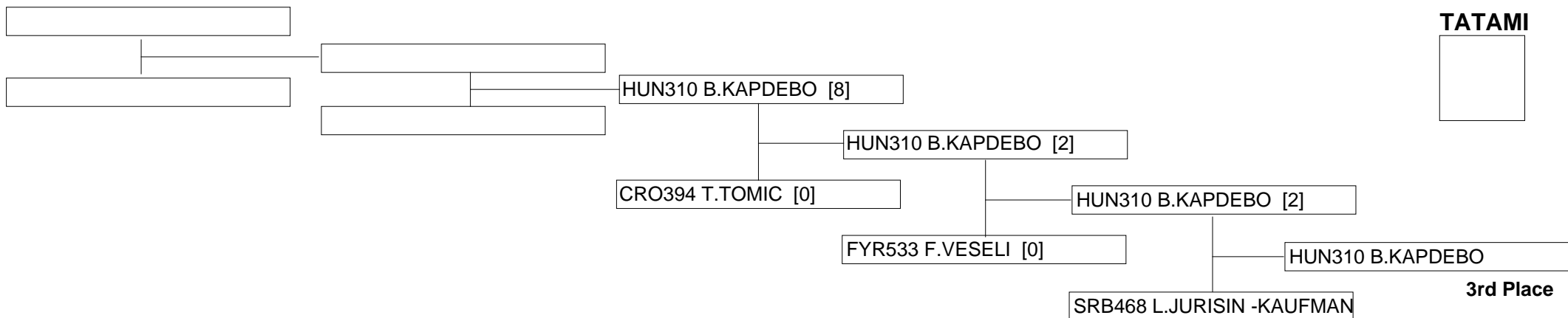

Repechage Pool 2

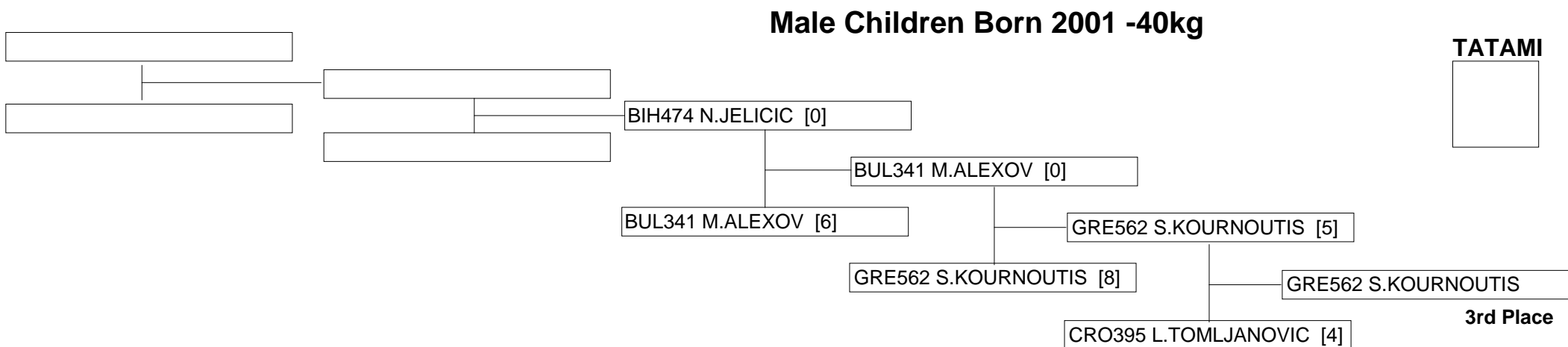



14th Balkan Cadet & Junior 3th U21 18th Children

SERBIA - Kragujevac

29/3/2013 - 31/3/2013

Male Children Born 2001 -45kg

Entries: 20

GRE751 G.PATISTAS [0]
BIH512 T.RISLJANIN [0]
SRB499 V.PETROVIC []
<BYE>
HUN305 D.GOLDFINGER []
<BYE>
MNE285 N.DAMJANOVIC []
<BYE>
FYR425 B.XHEMAILI [0]
SRB396 E.VUKASOVIC [0]
BUL342 R.ANDREOU []
<BYE>
GRE743 A.MENTIS []
<BYE>
HUN287 P.GYURUS []
<BYE>
TUR656 D.GUMUS [7]
BUL378 R.VAKARELOV [0]
BIH402 M.TARAHIJA []
<BYE>
MNE360 B.SKROBANOVIC []
<BYE>
FYR481 M.MEMEDI []
<BYE>
FYR516 M.PETROV [0]
HUN301 D.BESENJI [1]
GRE575 G.PAPAIOANNOU []
<BYE>
BUL303 P.GERGOV []
<BYE>
SRB354 M.MOSIC []
<BYE>

BIH512 T.RISLJANIN [6]
BIH512 T.RISLJANIN [0]
SRB499 V.PETROVIC [4]
HUN305 D.GOLDFINGER [4]
HUN305 D.GOLDFINGER [3]
MNE285 N.DAMJANOVIC [0]
SRB396 E.VUKASOVIC [3]
SRB396 E.VUKASOVIC [0]
BUL342 R.ANDREOU [0]
HUN287 P.GYURUS [0]
GRE743 A.MENTIS [0]
HUN287 P.GYURUS [1]
HUN287 P.GYURUS [8]
TUR656 D.GUMUS [4]
TUR656 D.GUMUS [2]
BIH402 M.TARAHIJA [0]
TUR656 D.GUMUS [8]
MNE360 B.SKROBANOVIC [0]
FYR481 M.MEMEDI [0]
FYR481 M.MEMEDI [3]
HUN301 D.BESENJI [1]
HUN301 D.BESENJI [3]
GRE575 G.PAPAIOANNOU [0]
HUN301 D.BESENJI [0]
BUL303 P.GERGOV [0]
SRB354 M.MOSIC [0]
SRB354 M.MOSIC [1]

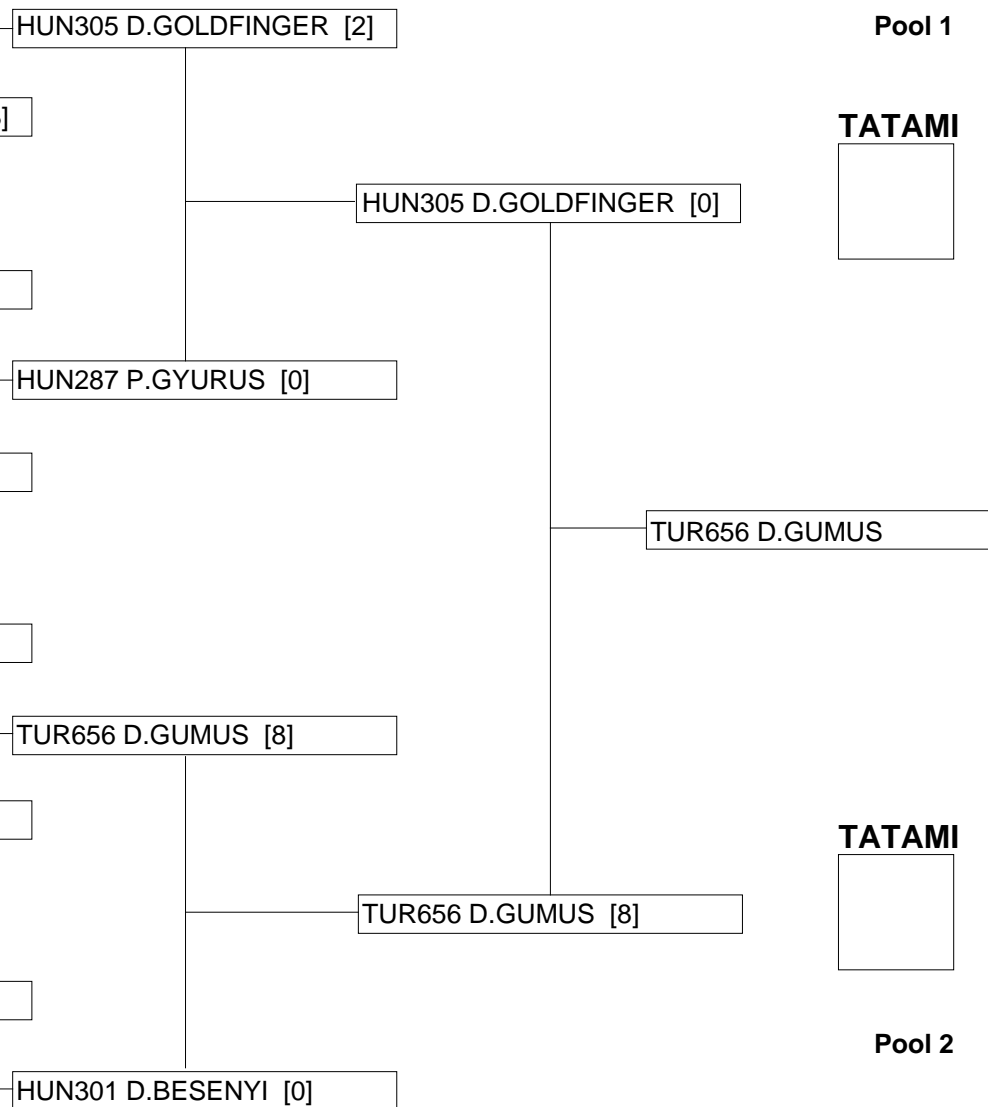

Pool 1

TATAMI



TATAMI

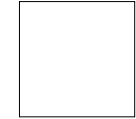

Pool 2

Male Children Born 2001 -45kg



14th Balkan Cadet & Junior 3th U21 18th Children

SERBIA - Kragujevac

29/3/2013 - 31/3/2013

Male Children Born 2001 -45kg

Repechage Pool 1

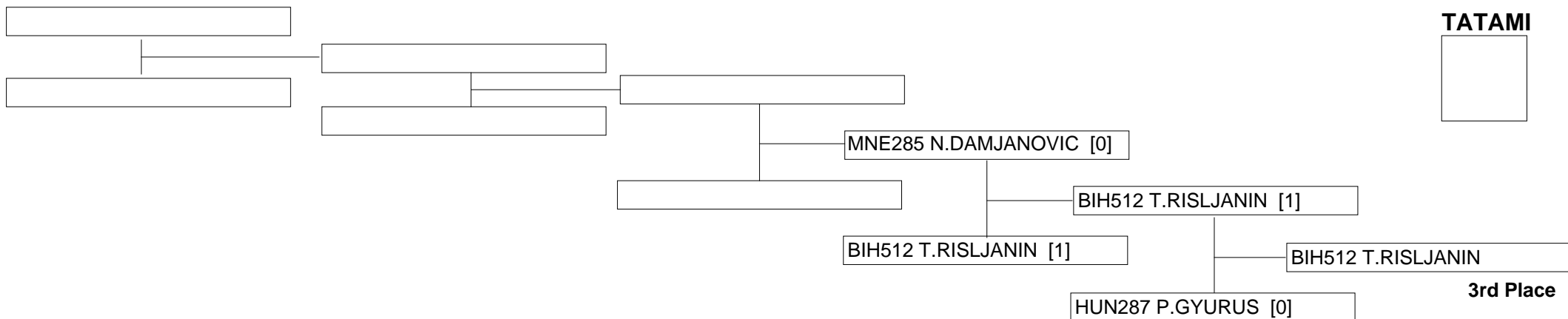

Repechage Pool 2

Male Children Born 2001 -45kg

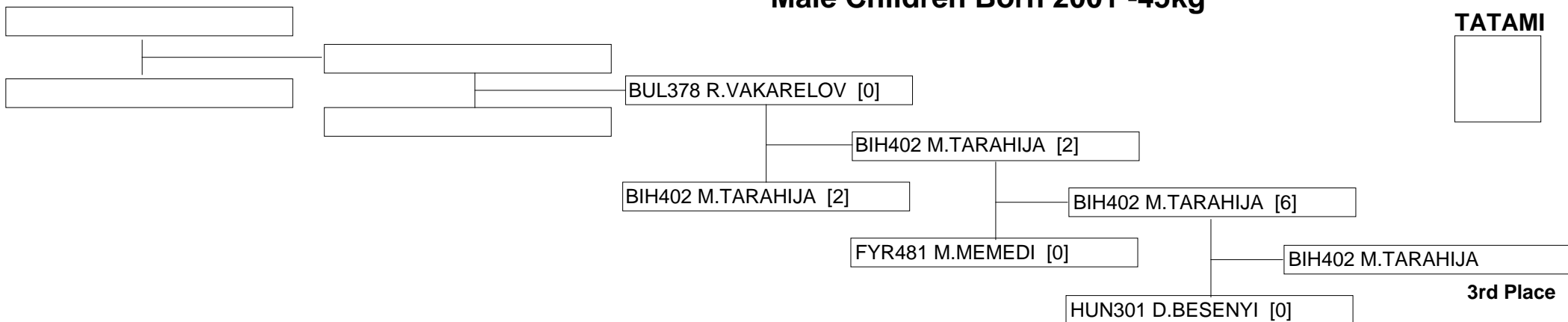



14th Balkan Cadet & Junior 3th U21 18th Children

SERBIA - Kragujevac

29/3/2013 - 31/3/2013

Male Children Born 2001 -50kg

Entries: 18

BIH528 A.DZANIC []
SRB498 S.PETROVIC []
BUL314 D.MAVRODIEV []
<BYE>

SRB498 S.PETROVIC [0]
BUL314 D.MAVRODIEV [0]
BUL314 D.MAVRODIEV [3]

MNE288 I.RADONJIC []
<BYE>

MNE288 I.RADONJIC [2]
MNE288 I.RADONJIC [7]

FYR530 D.TRAJKOSKI []
<BYE>

FYR530 D.TRAJKOSKI [0]

SRB544 N.MITROVIC []
<BYE>

SRB544 N.MITROVIC []
FYR489 M.ZHIVKOV [8]

FYR489 M.ZHIVKOV []
<BYE>

FYR489 M.ZHIVKOV []

BIH540 H.HUSKIC []
<BYE>

BIH540 H.HUSKIC [0]
GRE697 N.BOTSOS [0]

GRE697 N.BOTSOS []
<BYE>

GRE697 N.BOTSOS [3]

BIH492 A.MICIVODA [0]
SRB444 M.BACETIC [8]

SRB444 M.BACETIC [0]
BUL347 A.ASENOV [0]

BUL347 A.ASENOV []
<BYE>

BUL347 A.ASENOV [8]

FYR490 M.ACKOVSKI []
<BYE>

FYR490 M.ACKOVSKI [0]
GRE590 I.TSIRNOVAS [1]

GRE590 I.TSIRNOVAS []
<BYE>

GRE590 I.TSIRNOVAS [4]

TUR796 M.HAYIR []
<BYE>

TUR796 M.HAYIR []
TUR796 M.HAYIR [0]

GRE742 K.MAVRELIS []
<BYE>

GRE742 K.MAVRELIS []

MNE294 B.BOSKOVIC []
<BYE>

MNE294 B.BOSKOVIC [7]
MNE294 B.BOSKOVIC [2]

BUL359 L.IVANOV []
<BYE>

BUL359 L.IVANOV [0]

MNE288 I.RADONJIC [6]

MNE288 I.RADONJIC [0]

FYR489 M.ZHIVKOV [0]

GRE697 N.BOTSOS [0]

MNE294 B.BOSKOVIC

GRE590 I.TSIRNOVAS [1]

GRE590 I.TSIRNOVAS [3]

MNE294 B.BOSKOVIC [1]

MNE294 B.BOSKOVIC [2]

Pool 1

TATAMI



TATAMI

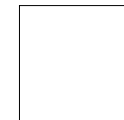

Pool 2

Male Children Born 2001 -50kg



14th Balkan Cadet & Junior 3th U21 18th Children

SERBIA - Kragujevac

29/3/2013 - 31/3/2013

Male Children Born 2001 -50kg

Repechage Pool 1

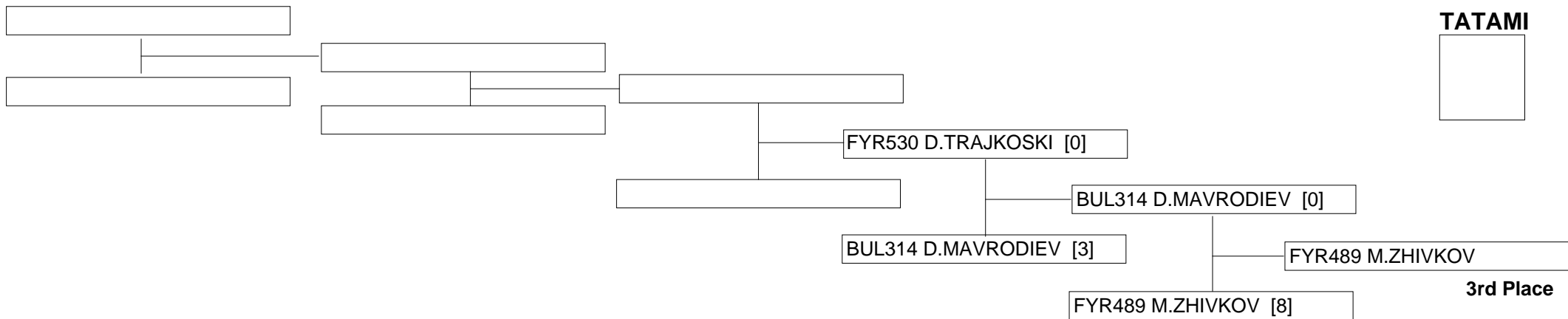

Repechage Pool 2

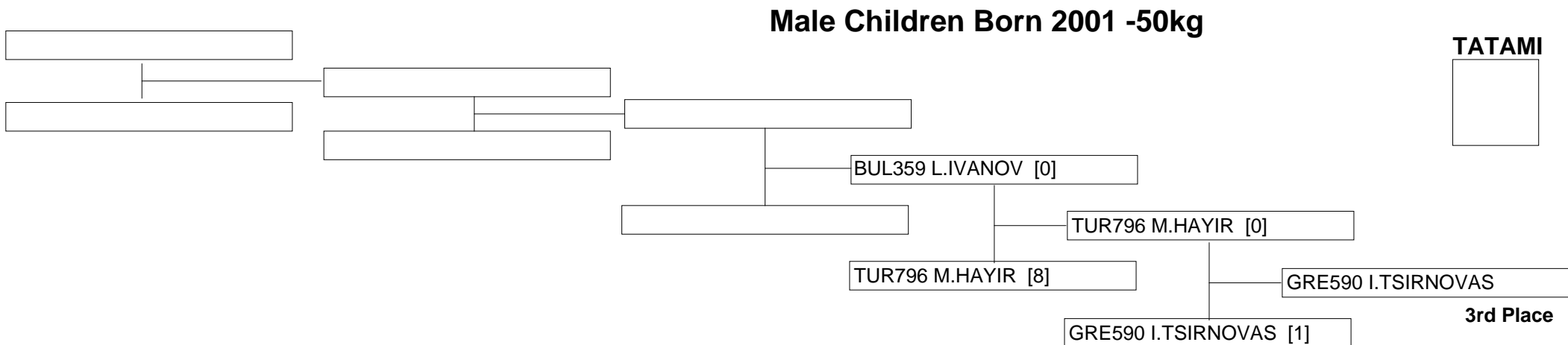



14th Balkan Cadet & Junior 3th U21 18th Children

SERBIA - Kragujevac

29/3/2013 - 31/3/2013

Male Children Born 2002 45+kg

Entries: 12



Male Children Born 2002 45+kg



14th Balkan Cadet & Junior 3th U21 18th Children

SERBIA - Kragujevac

29/3/2013 - 31/3/2013

Male Children Born 2002 45+kg

Repechage Pool 1

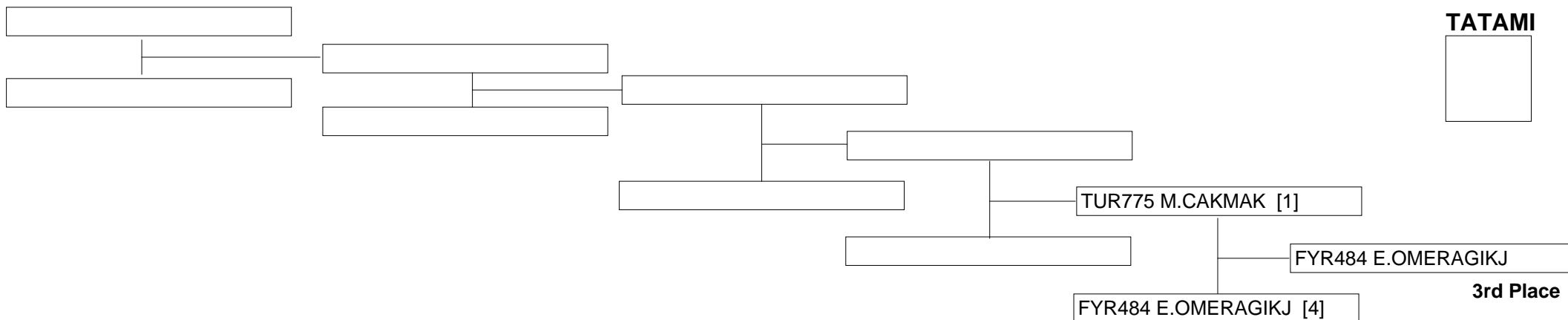

Repechage Pool 2

Male Children Born 2002 45+kg

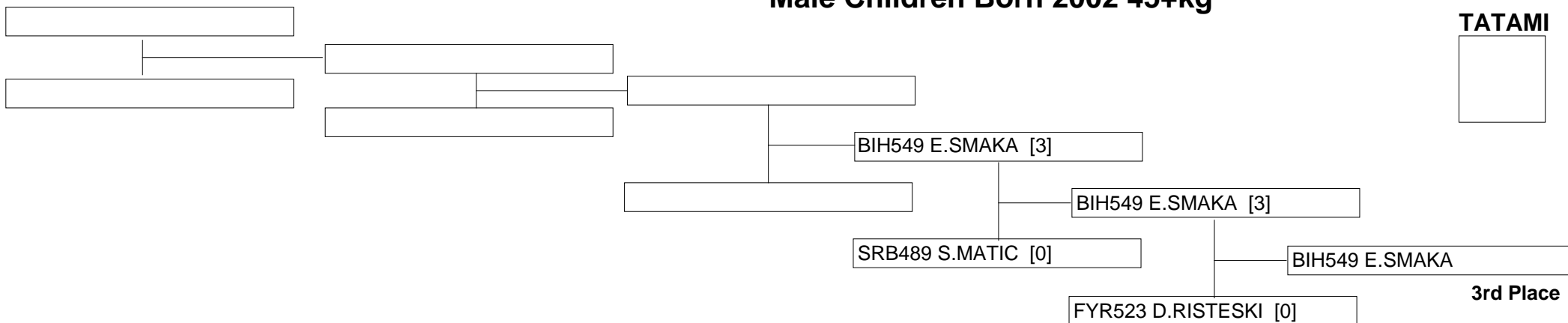



14th Balkan Cadet & Junior 3th U21 18th Children

SERBIA - Kragujevac

29/3/2013 - 31/3/2013

Male Children Born 2002 -30kg

Entries: 18

BIH460 P.DUJAKOVIC [0]
SRB465 S.JOVANOVIC [4]
FYR478 S.KOSTADINOSKI []
<BYE>
GRE696 G.BILIAS []
<BYE>
BUL376 D.STOYANOV []
<BYE>
MNE385 F.CETKOVIC []
<BYE>
ALB173 F.LLESHI []
<BYE>
BUL343 I.ANGELOV []
<BYE>
FYR471 P.GJORGJIOSKI []
<BYE>
BIH485 E.KRSO [8]
FYR511 H.MICESKI [0]
BUL345 T.APOSTOLOV []
<BYE>
GRE708 P.FLOROS []
<BYE>
ALB175 F.MICI []
<BYE>
BIH491 A.MATIC []
<BYE>
TUR785 Z.EKER []
<BYE>
GRE767 K.LEBESIS []
<BYE>
SRB532 L.VUKICEVIC []
<BYE>



Male Children Born 2002 -30kg



14th Balkan Cadet & Junior 3th U21 18th Children

SERBIA - Kragujevac

29/3/2013 - 31/3/2013

Male Children Born 2002 -30kg

Repechage Pool 1

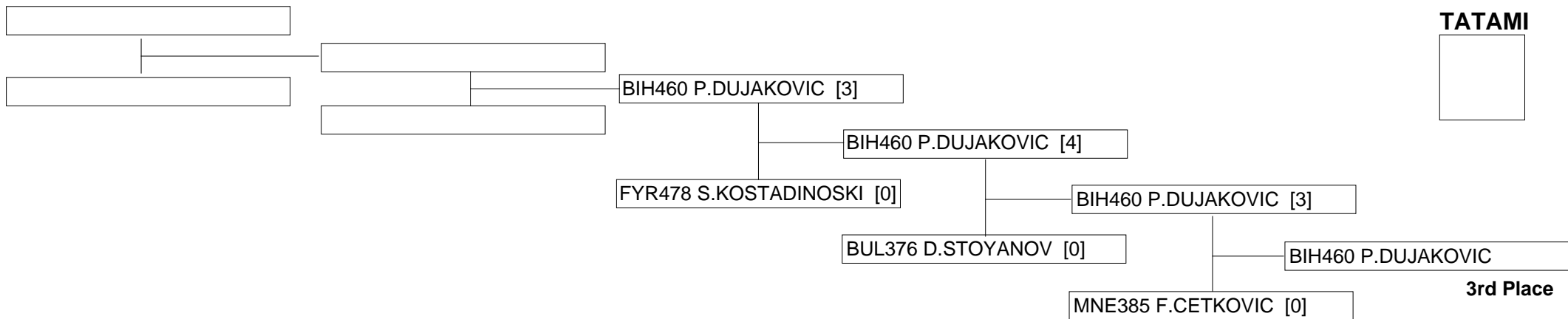

Repechage Pool 2

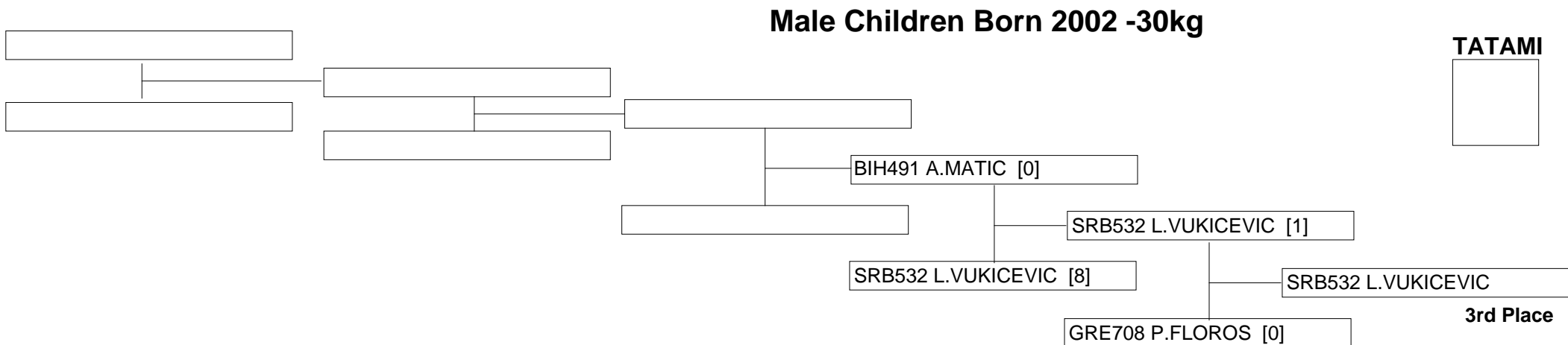



14th Balkan Cadet & Junior 3th U21 18th Children

SERBIA - Kragujevac

29/3/2013 - 31/3/2013

Male Children Born 2002 -35kg

Entries: 21

ALB166 P.CAKALLI [0]
CYR331 S.IOANNOU [8]
HUN292 C.KOSZKA []
<BYE>

CYR331 S.IOANNOU [3]
HUN292 C.KOSZKA [6]

HUN292 C.KOSZKA [0]

FYR504 V.JANEVSKI [0]
BIH556 A.PATKOVIC [4]

BIH556 A.PATKOVIC [1]
MNE383 B.SADIKOVIC [0]

BIH556 A.PATKOVIC [2]

MNE383 B.SADIKOVIC []
<BYE>

SRB490 M.MIHAJLOVIC [9]
BUL381 E.YORDANOV [3]

SRB490 M.MIHAJLOVIC [2]
BIH523 M.TOMIC [3]

BIH523 M.TOMIC [8]

BIH523 M.TOMIC []
<BYE>

GRE720 E.KARALEXIS []
<BYE>

GRE720 E.KARALEXIS [1]
TUR799 I.KABAHASANOGLU []

TUR799 I.KABAHASANOGLU []

TUR799 I.KABAHASANOGLU []
<BYE>

TUR798 M.IYIKESICI [3]
BIH498 H.MURADBASIC [0]

TUR798 M.IYIKESICI [7]
BUL351 L.BOSILKOV [0]

TUR798 M.IYIKESICI [5]

BUL351 L.BOSILKOV []
<BYE>

SRB485 A.MARJANOVIC []
<BYE>

SRB485 A.MARJANOVIC [2]
GRE758 S.SKOUZAKIS [0]

SRB485 A.MARJANOVIC [0]

GRE758 S.SKOUZAKIS []
<BYE>

SRB480 S.LEMAJIC [0]
BUL382 K.YORDANOV [2]

BUL382 K.YORDANOV [0]
FYR527 M.SVINARSKI [8]

FYR527 M.SVINARSKI [2]

FYR527 M.SVINARSKI []
<BYE>

GRE754 A.SAMAKOVLIS []
<BYE>

GRE754 A.SAMAKOVLIS [0]
MNE372 J.DZEVERDANOVIC []

MNE372 J.DZEVERDANOVIC []

MNE372 J.DZEVERDANOVIC []
<BYE>



Pool 1

TATAMI

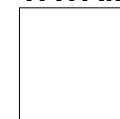

TATAMI

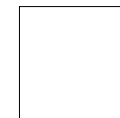

Pool 2

Male Children Born 2002 -35kg



14th Balkan Cadet & Junior 3th U21 18th Children

SERBIA - Kragujevac

29/3/2013 - 31/3/2013

Male Children Born 2002 -35kg

Repechage Pool 1

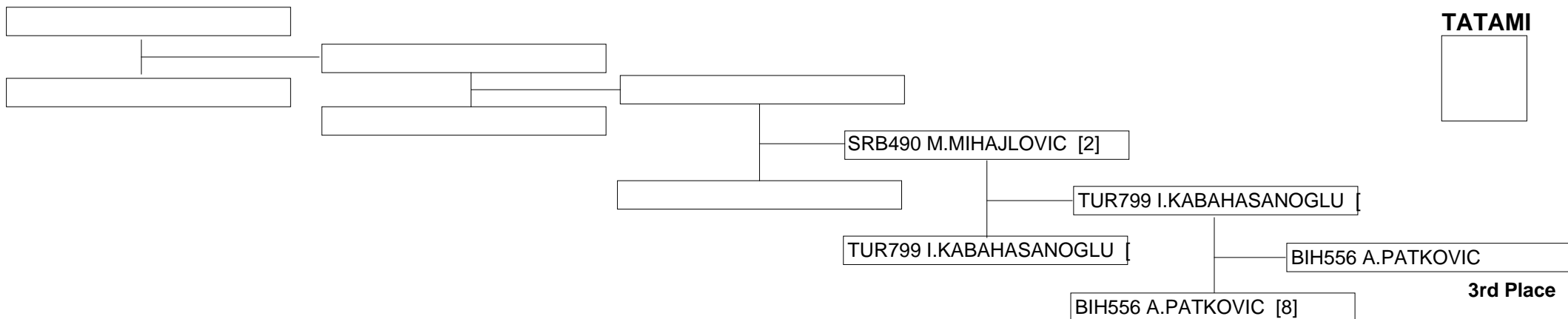

Repechage Pool 2

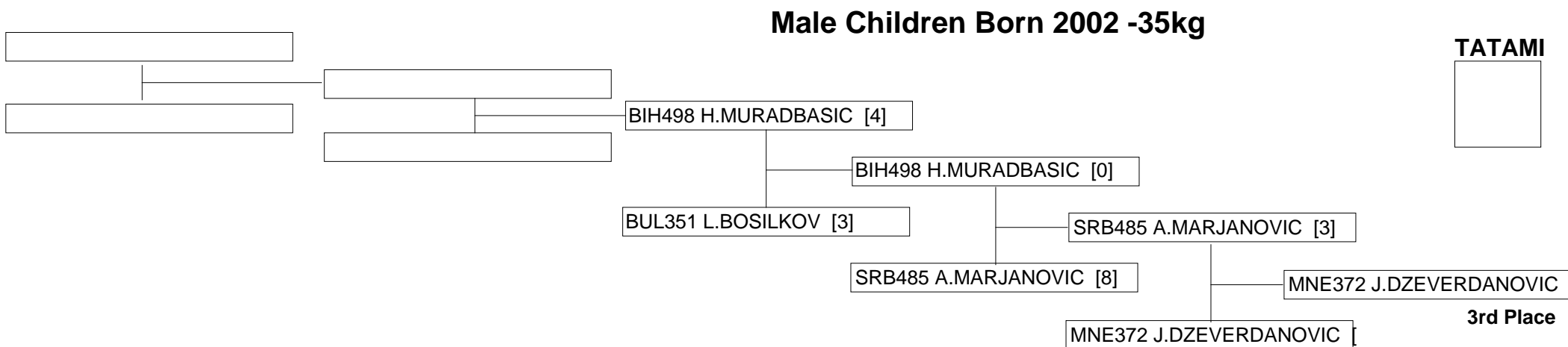



14th Balkan Cadet & Junior 3th U21 18th Children

SERBIA - Kragujevac

29/3/2013 - 31/3/2013

Male Children Born 2002 -40kg

Entries: 19

BIH497 S.MULAHALILOVIC [0]
HUN284 M.BILISICS [8]
GRE699 V.BOURADANIS []
<BYE>
TUR782 R.DOGAN []
<BYE>
SRB531 L.VUJOVIC []
<BYE>
CYR321 E.DEMOSTHENOUS [
BUL357 T.HRISTOV [8]
TUR772 B.BAYRAM []
<BYE>
FYR508 I.LAZAROVSKI []
<BYE>
MNE406 D.VUJOSEVIC []
<BYE>
TUR771 M.BAYLAN []
SRB521 P.STOJANOVIC []
GRE709 F.GIANNAKOPOULOS
<BYE>
FYR526 D.SPIROVSKI []
<BYE>
BIH521 N.SUVALIJA []
<BYE>
BUL373 R.REDZHEPI []
<BYE>
SRB453 P.DOGANJIC []
<BYE>
GRE756 E.SEREMETAKIS []
<BYE>
MNE392 M.DRAGOJEVIC []
<BYE>



Male Children Born 2002 -40kg



14th Balkan Cadet & Junior 3th U21 18th Children

SERBIA - Kragujevac

29/3/2013 - 31/3/2013

Male Children Born 2002 -40kg

Repechage Pool 1

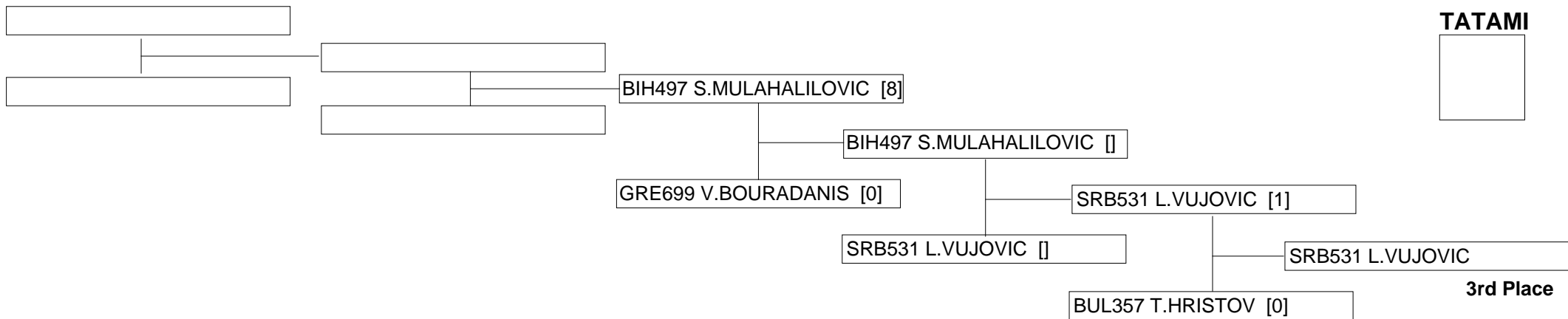

Repechage Pool 2

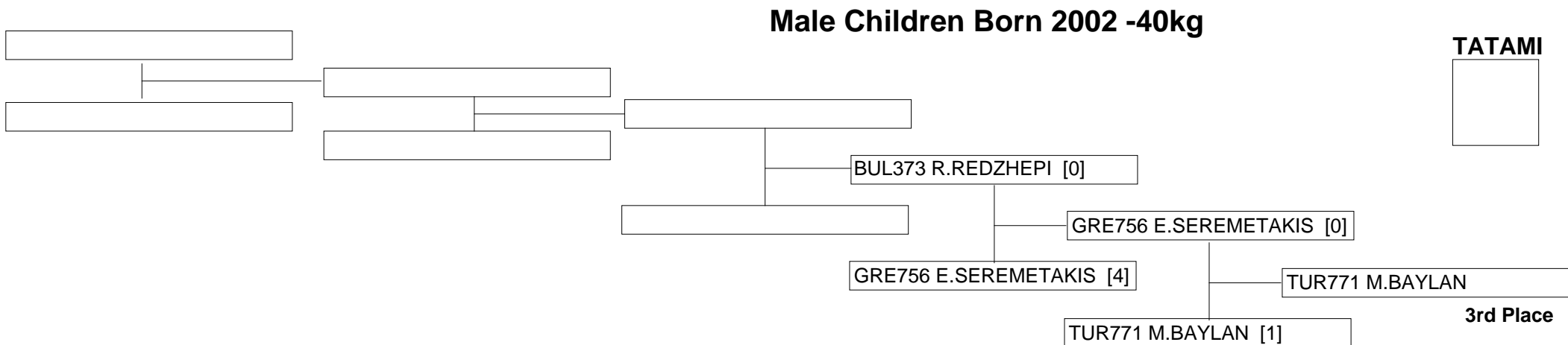



14th Balkan Cadet & Junior 3th U21 18th Children

SERBIA - Kragujevac

29/3/2013 - 31/3/2013

Male Children Born 2002 -45kg

Entries: 18

MNE394 A.FATIC [4]
GRE717 G.KALAPOTHARAKO
BUL377 M.TRUSHKOV []
<BYE>
SRB543 M.RISTOVIC []
<BYE>
ALB172 J.KOLA []
<BYE>
FYR510 B.MANCEVSKI []
<BYE>
SRB442 M.ANDRIC []
<BYE>
GRE733 A.LACHANAS []
<BYE>
BIH479 A.KARAMUSTAFIC []
<BYE>
BIH490 D.MAHMUTOVIC [0]
SRB492 M.MUSTA [5]
BUL368 K.NIKOLAEV []
<BYE>
FYR513 I.MISHACHKOVSKI []
<BYE>
GRE750 K.PARASCHOPOULO
<BYE>
BUL346 A.APRILOV []
<BYE>
CYR330 A.GAVALAS []
<BYE>
FYR532 V.VEJSELI []
<BYE>
TUR823 A.YAMAN []
<BYE>





14th Balkan Cadet & Junior 3th U21 18th Children

SERBIA - Kragujevac

29/3/2013 - 31/3/2013

Male Children Born 2002 -45kg

Repechage Pool 1

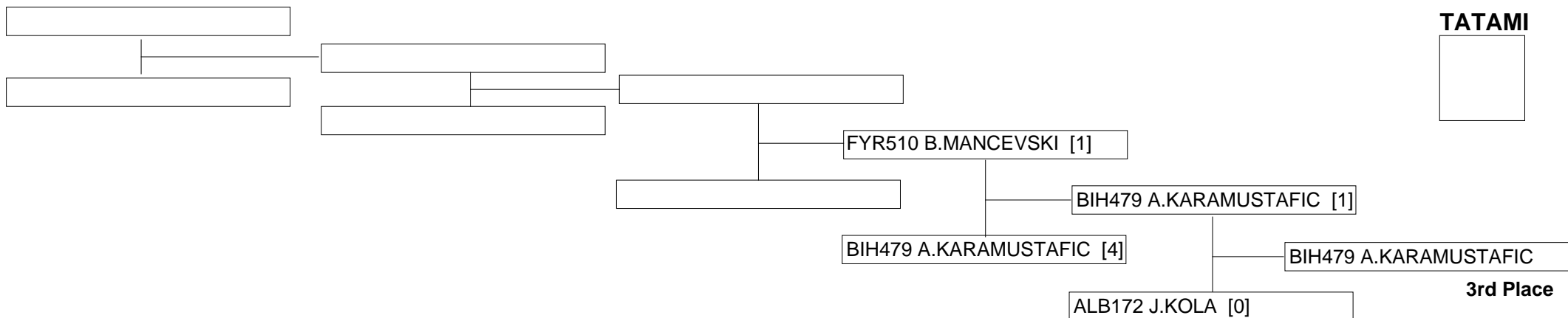

Repechage Pool 2

Male Children Born 2002 -45kg

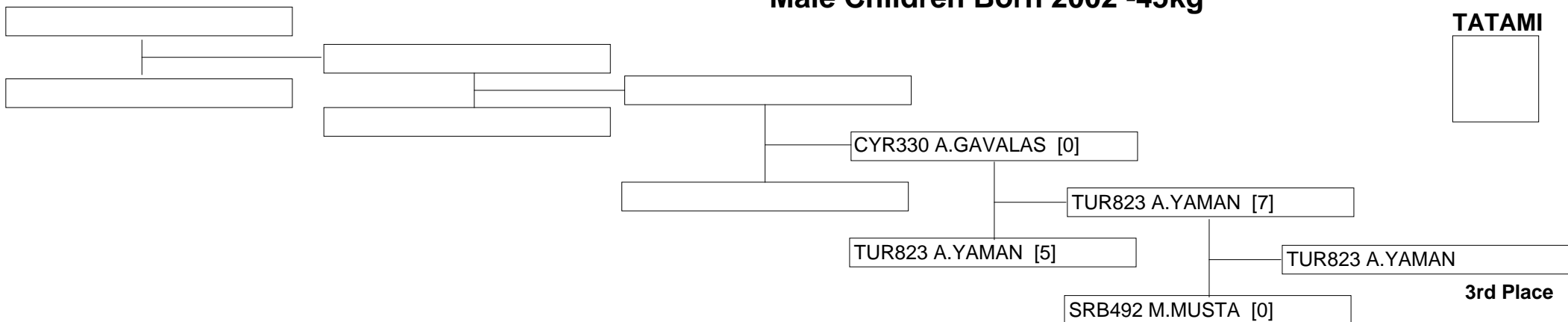



14th Balkan Cadet & Junior 3th U21 18th Children

SERBIA - Kragujevac

29/3/2013 - 31/3/2013

Female Children Born1999 54+kg

Entries: 19

GRE518 M.TSAGKARI [3]
TUR786 E.ELTEMUR [2]
CYR275 M.STAVROU []
<BYE>
SRB351 N.KOJOVIC []
<BYE>
BUL297 I.IVANOVA []
<BYE>
GRE741 S.MATSOUKA [0]
TUR811 H.PUNAR [3]
FYR333 A.MATESKA []
<BYE>
SRB371 S.VARSAKOVIC []
<BYE>
BIH537 E.FERIZOVIC []
<BYE>
GRE408 G.CHATZILIADOU [1]
SRB452 K.DAKIC [0]
BIH489 D.LONCIC []
<BYE>
BUL330 V.VASILEVA []
<BYE>
TUR821 B.TURGUT []
<BYE>
FYR407 E.JANJIKJ []
<BYE>
BIH442 M.DUNIC []
<BYE>
BUL332 E.YANEVA []
<BYE>
MNE320 K.MILICKOVIC []
<BYE>

GRE518 M.TSAGKARI [8]
GRE518 M.TSAGKARI [5]
CYR275 M.STAVROU [0]
GRE518 M.TSAGKARI [1]
SRB351 N.KOJOVIC [1]
SRB351 N.KOJOVIC [0]
BUL297 I.IVANOVA [0]
TUR811 H.PUNAR [7]
TUR811 H.PUNAR [1]
FYR333 A.MATESKA [0]
TUR811 H.PUNAR [0]
SRB371 S.VARSAKOVIC [8]
SRB371 S.VARSAKOVIC [0]
BIH537 E.FERIZOVIC [0]
GRE408 G.CHATZILIADOU [6]
GRE408 G.CHATZILIADOU [4]
BIH489 D.LONCIC [1]
GRE408 G.CHATZILIADOU [3]
BUL330 V.VASILEVA [1]
TUR821 B.TURGUT [0]
TUR821 B.TURGUT [3]
FYR407 E.JANJIKJ [1]
FYR407 E.JANJIKJ [8]
BIH442 M.DUNIC [0]
FYR407 E.JANJIKJ [0]
BUL332 E.YANEVA [0]
MNE320 K.MILICKOVIC [0]
MNE320 K.MILICKOVIC [5]

GRE518 M.TSAGKARI [1]

GRE518 M.TSAGKARI [1]

TUR811 H.PUNAR [0]

SRB371 S.VARSAKOVIC [0]

GRE408 G.CHATZILIADOU

GRE408 G.CHATZILIADOU [3]

TUR821 B.TURGUT [0]

GRE408 G.CHATZILIADOU [4]

FYR407 E.JANJIKJ [8]

FYR407 E.JANJIKJ [0]

MNE320 K.MILICKOVIC [0]

Pool 1

TATAMI

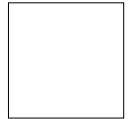

TATAMI

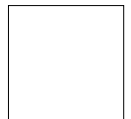

Pool 2

Female Children Born1999 54+kg



14th Balkan Cadet & Junior 3th U21 18th Children

SERBIA - Kragujevac

29/3/2013 - 31/3/2013

Female Children Born1999 54+kg

Repechage Pool 1

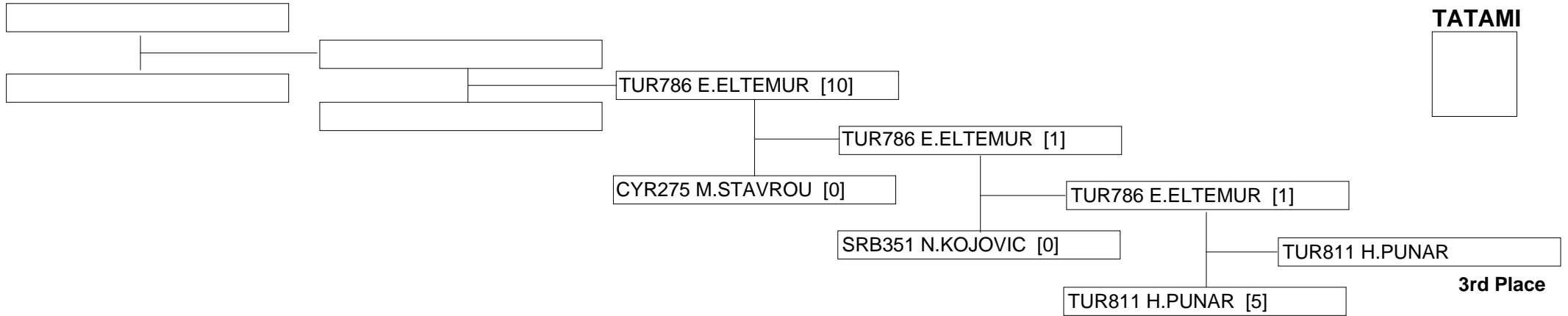

Repechage Pool 2

Female Children Born1999 54+kg

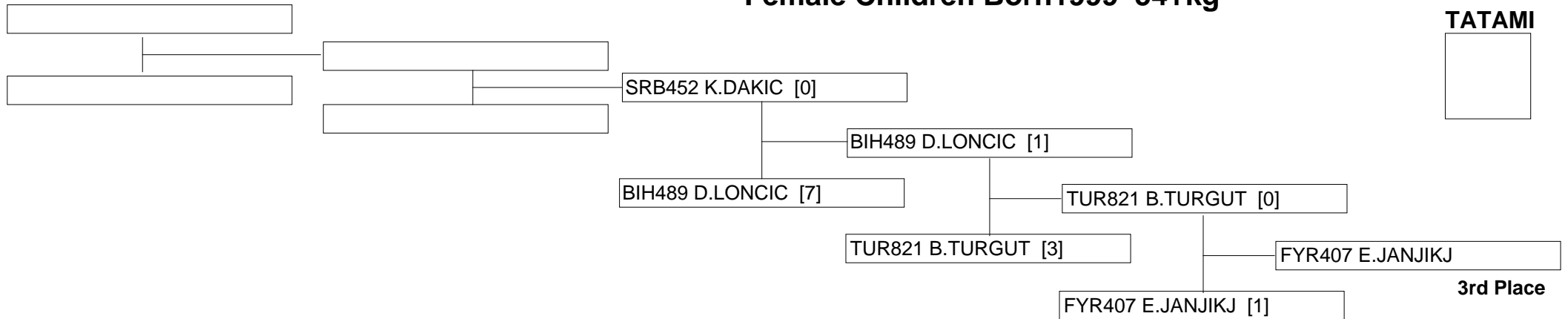



14th Balkan Cadet & Junior 3th U21 18th Children

SERBIA - Kragujevac

29/3/2013 - 31/3/2013

Female Children Born1999 -47kg

Entries: 17

FYR466 A.AMETI [0]
BIH394 M.MEDIC [8]
SRB545 J.TOPALOV []
<BYE>
TUR770 C.BASKAN []
<BYE>
GRE581 M.SIAVELI []
<BYE>
MNE363 I.VUKMIROVIC []
<BYE>
GRE403 N.KARAMANOU []
<BYE>
BIH338 S.AKSAMOVIC []
<BYE>
SRB402 S.PETROVIC []
<BYE>
FYR373 A.CURI []
<BYE>
TUR777 E.CAVDARO []
<BYE>
MNE210 K.GREDIC []
<BYE>
CYR259 R.MARKIDI []
<BYE>
FYR303 D.MANGOVSKA []
<BYE>
BIH532 G.BEGIC []
<BYE>
GRE488 F.MAMOGLOU []
<BYE>
SRB546 T.RADULOVIC []
<BYE>

BIH394 M.MEDIC [2]
BIH394 M.MEDIC [3]
SRB545 J.TOPALOV [0]
BIH394 M.MEDIC [4]
TUR770 C.BASKAN [8]
TUR770 C.BASKAN [0]
GRE581 M.SIAVELI [0]
MNE363 I.VUKMIROVIC [0]
GRE403 N.KARAMANOU [4]
GRE403 N.KARAMANOU [8]
GRE403 N.KARAMANOU [0]
BIH338 S.AKSAMOVIC [8]
BIH338 S.AKSAMOVIC [0]
SRB402 S.PETROVIC [0]
FYR373 A.CURI [0]
TUR777 E.CAVDARO [8]
TUR777 E.CAVDARO [5]
TUR777 E.CAVDARO [7]
MNE210 K.GREDIC [8]
MNE210 K.GREDIC [0]
CYR259 R.MARKIDI [0]
FYR303 D.MANGOVSKA [0]
BIH532 G.BEGIC [4]
BIH532 G.BEGIC [1]
BIH532 G.BEGIC [1]
GRE488 F.MAMOGLOU [2]
SRB546 T.RADULOVIC [0]
SRB546 T.RADULOVIC [3]

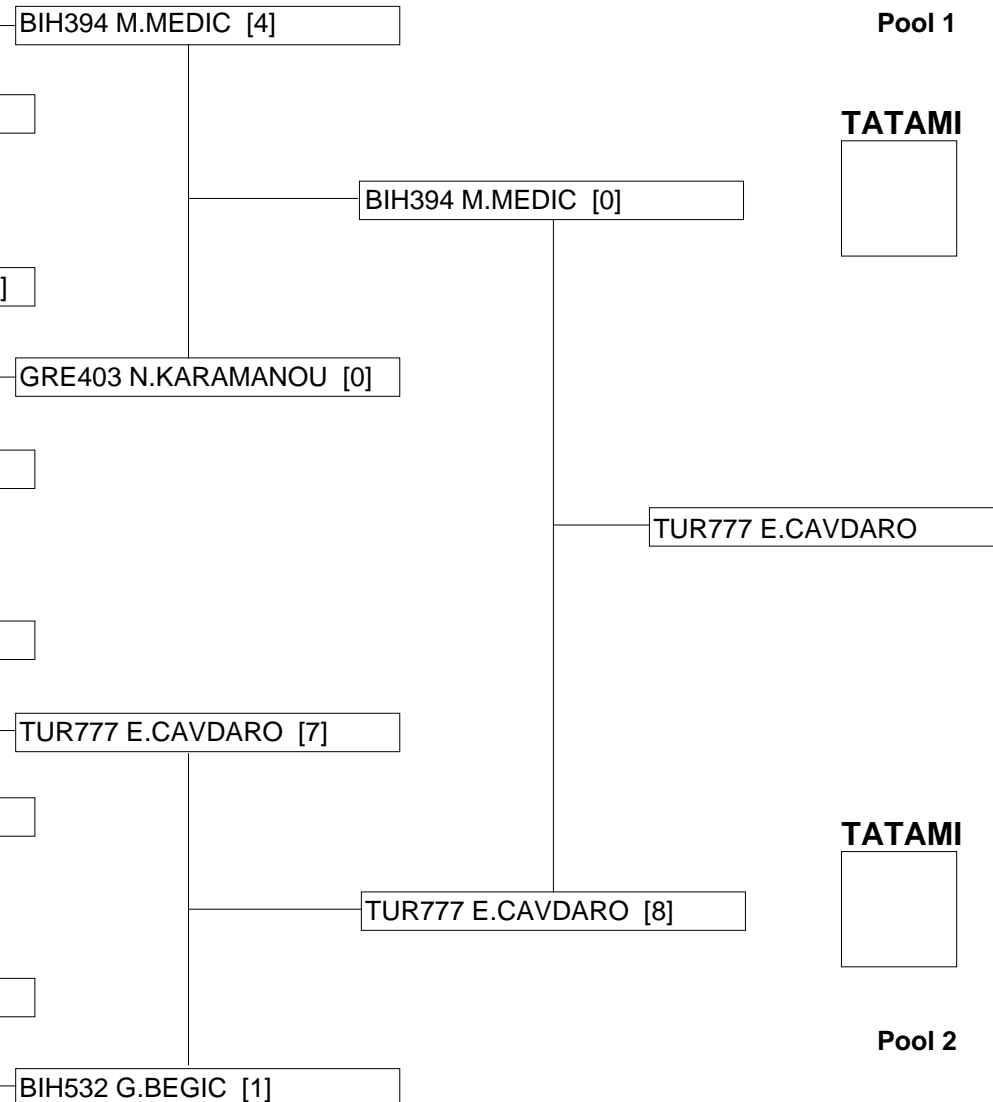

Pool 1

TATAMI



TATAMI

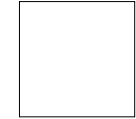

Pool 2

Female Children Born1999 -47kg



14th Balkan Cadet & Junior 3th U21 18th Children

SERBIA - Kragujevac

29/3/2013 - 31/3/2013

Female Children Born1999 -47kg

Repechage Pool 1

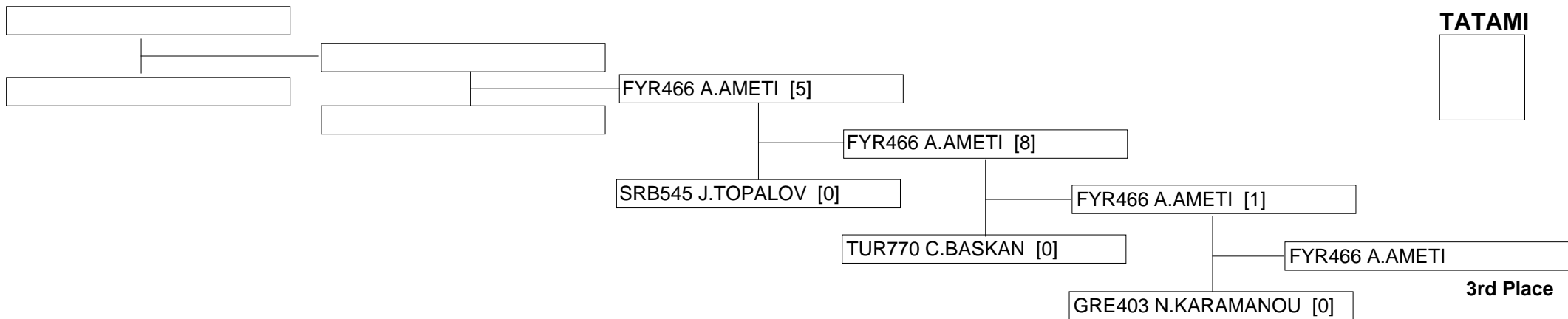

Repechage Pool 2

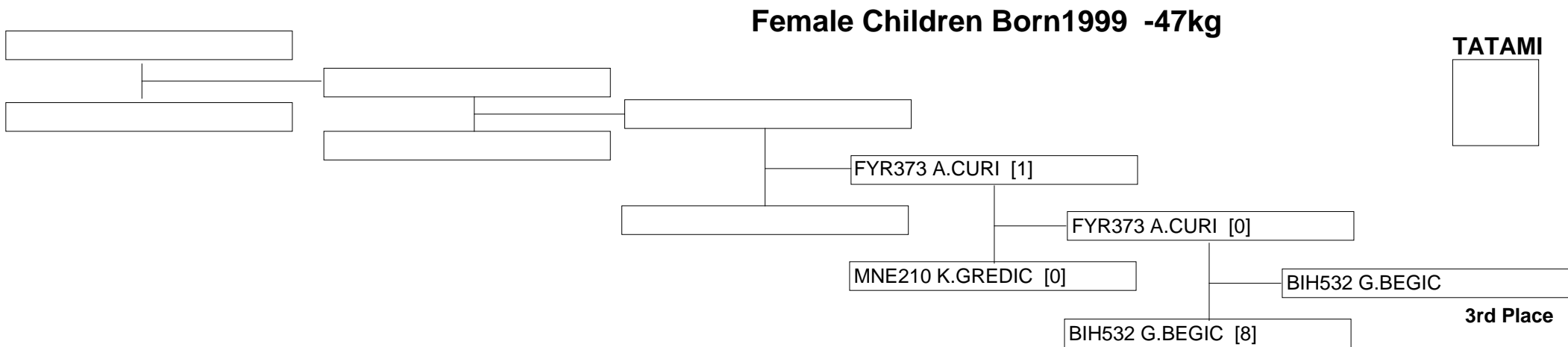



14th Balkan Cadet & Junior 3th U21 18th Children

SERBIA - Kragujevac

29/3/2013 - 31/3/2013

Female Children Born1999 -54kg

Entries: 17

TUR643 H.BASKAYA [10]
GRE762 S.TSAOUSI [0]
FYR367 V.KOSTOVSKA []
<BYE>
BIH451 N.AJANOVIC []
<BYE>
SRB439 M.VUCIC []
<BYE>
SRB530 A.VUJASINOVIC []
<BYE>
BIH559 A.TADIC []
<BYE>
BUL321 M.PETROVA []
<BYE>
GRE411 V.GRAVANI []
<BYE>
FYR453 S.TAUSHANOVA []
<BYE>
BUL264 V.ROSEVA []
<BYE>
SRB522 I.STOJKOVIC []
<BYE>
TUR764 Y.ALKAN []
<BYE>
BIH423 N.TOPIC []
<BYE>
MNE324 K.RAJOVIC []
<BYE>
GRE393 E.KOUSOULI []
<BYE>
BUL353 N.DIMOVA []
<BYE>

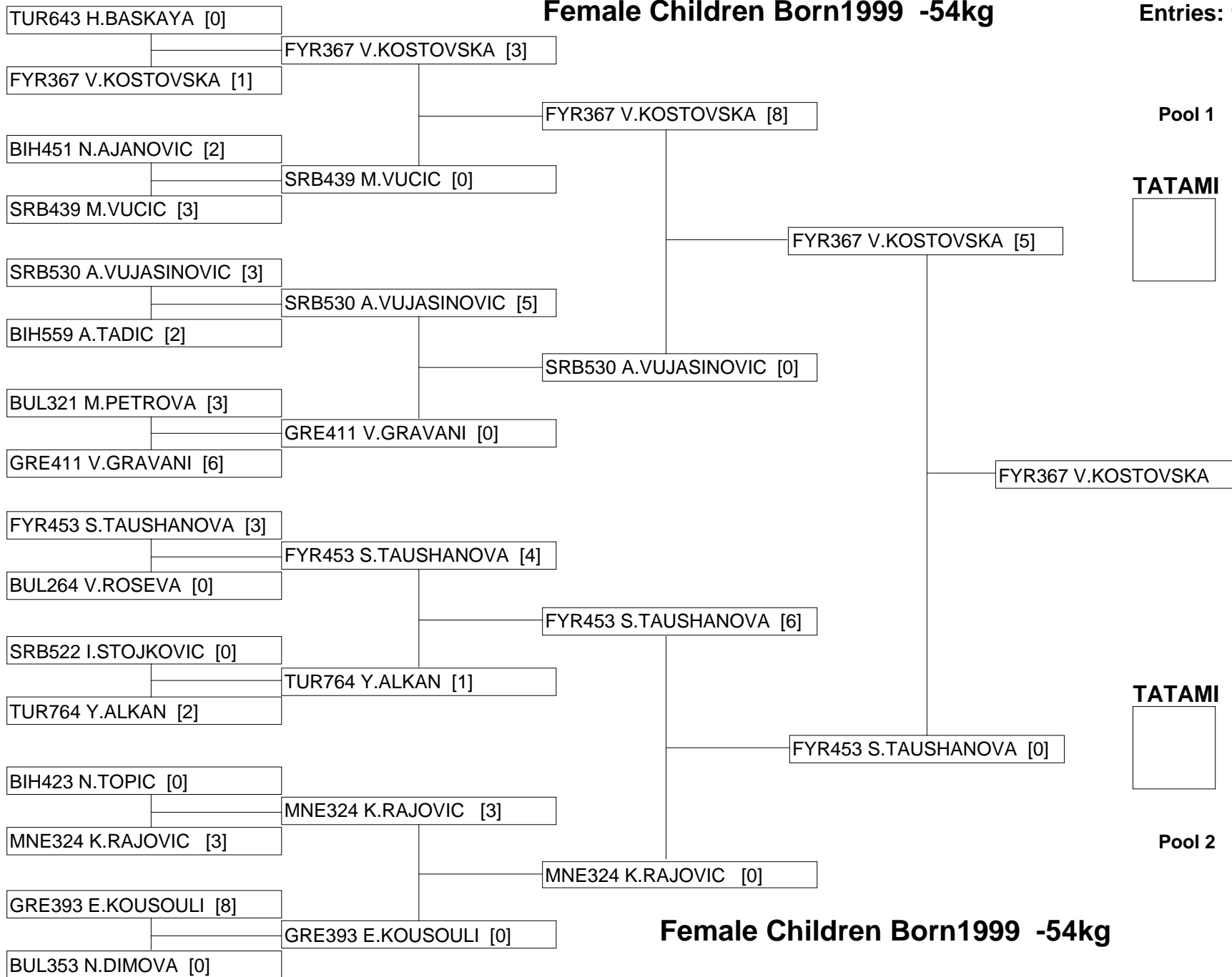

Female Children Born1999 -54kg



14th Balkan Cadet & Junior 3th U21 18th Children

SERBIA - Kragujevac

29/3/2013 - 31/3/2013

Female Children Born1999 -54kg

Repechage Pool 1

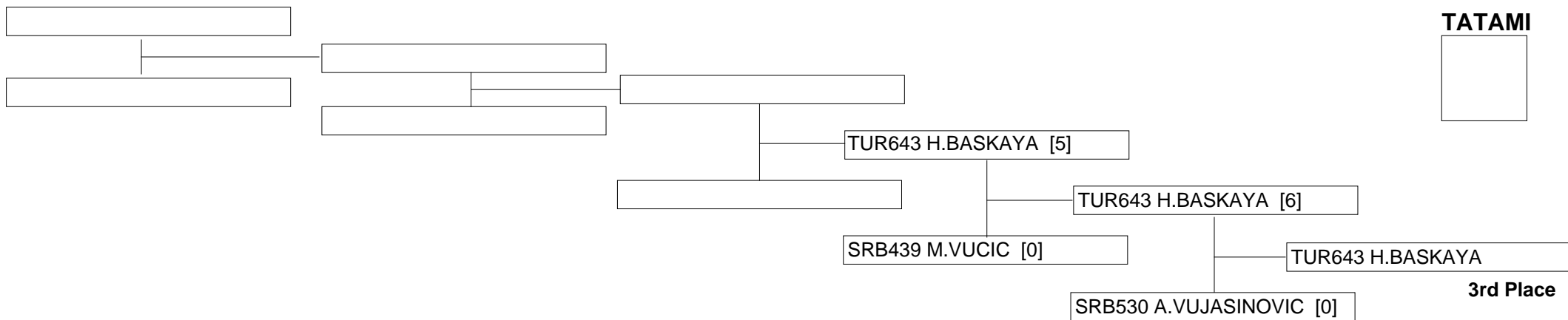

Repechage Pool 2

Female Children Born1999 -54kg

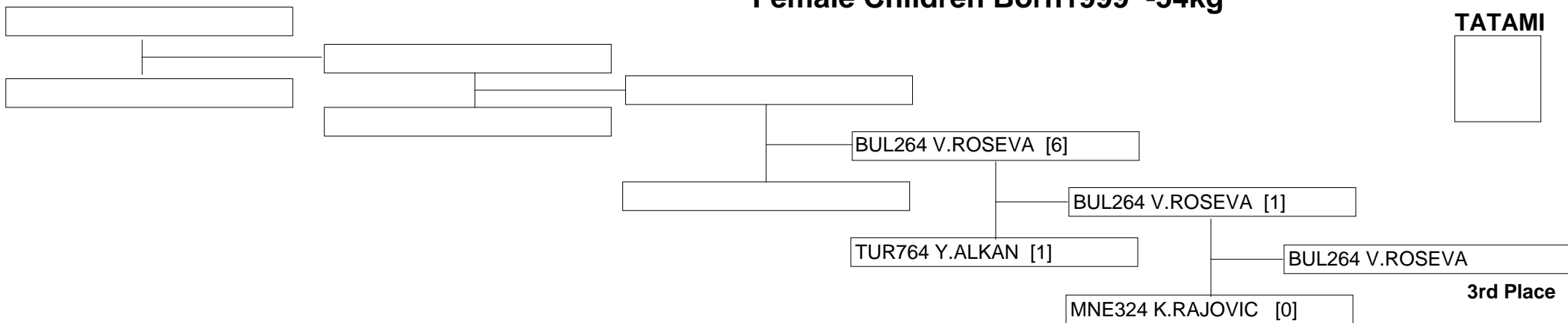



14th Balkan Cadet & Junior 3th U21 18th Children

SERBIA - Kragujevac

29/3/2013 - 31/3/2013

Female Children Born 2000 47+kg

Entries: 16



Female Children Born 2000 47+kg



14th Balkan Cadet & Junior 3th U21 18th Children

SERBIA - Kragujevac

29/3/2013 - 31/3/2013

Female Children Born 2000 47+kg

Repechage Pool 1

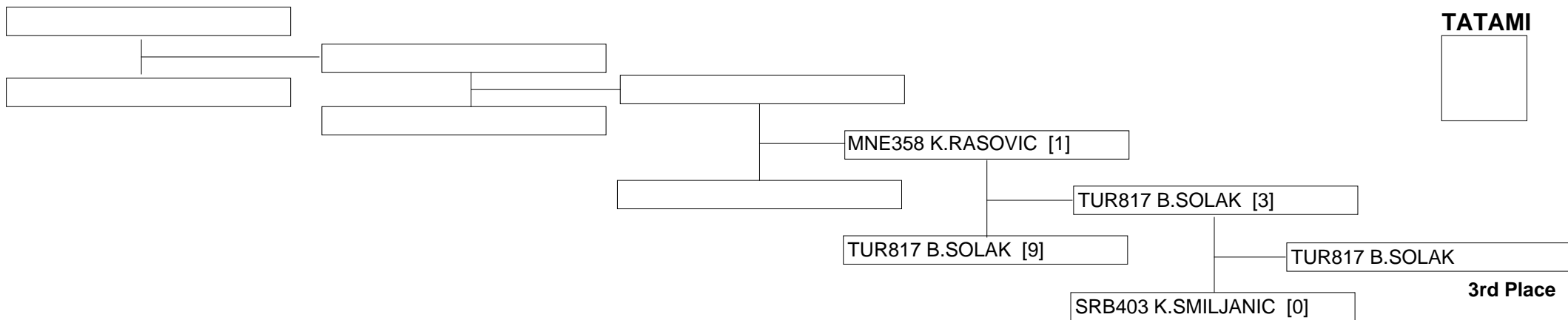

Repechage Pool 2

Female Children Born 2000 47+kg

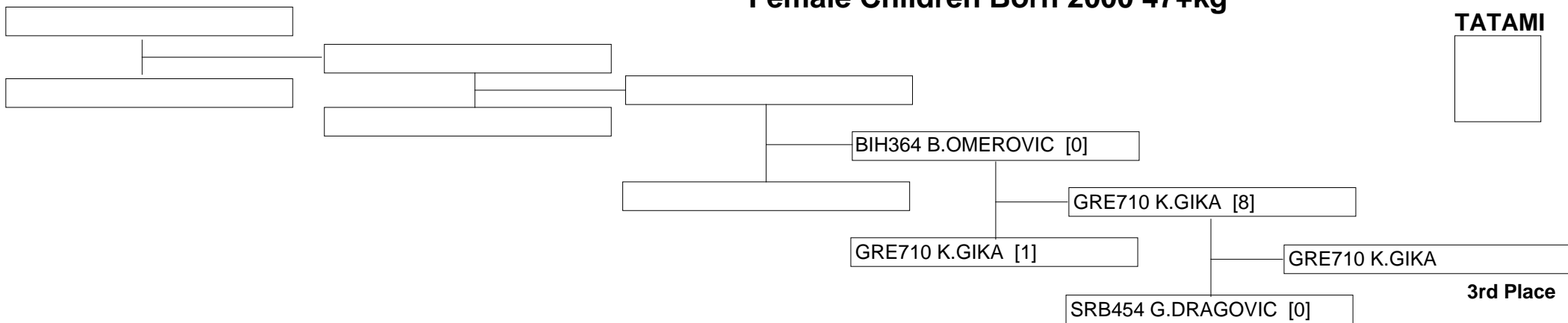



14th Balkan Cadet & Junior 3th U21 18th Children

SERBIA - Kragujevac

29/3/2013 - 31/3/2013

Female Children Born 2000 -42kg

Entries: 16



Female Children Born 2000 -42kg



14th Balkan Cadet & Junior 3th U21 18th Children

SERBIA - Kragujevac

29/3/2013 - 31/3/2013

Female Children Born 2000 -42kg

Repechage Pool 1

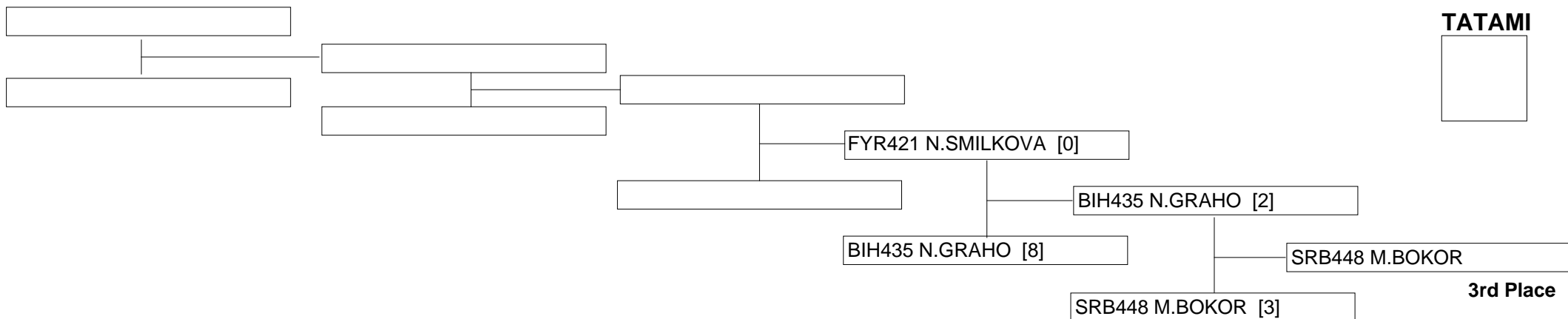

Repechage Pool 2

Female Children Born 2000 -42kg

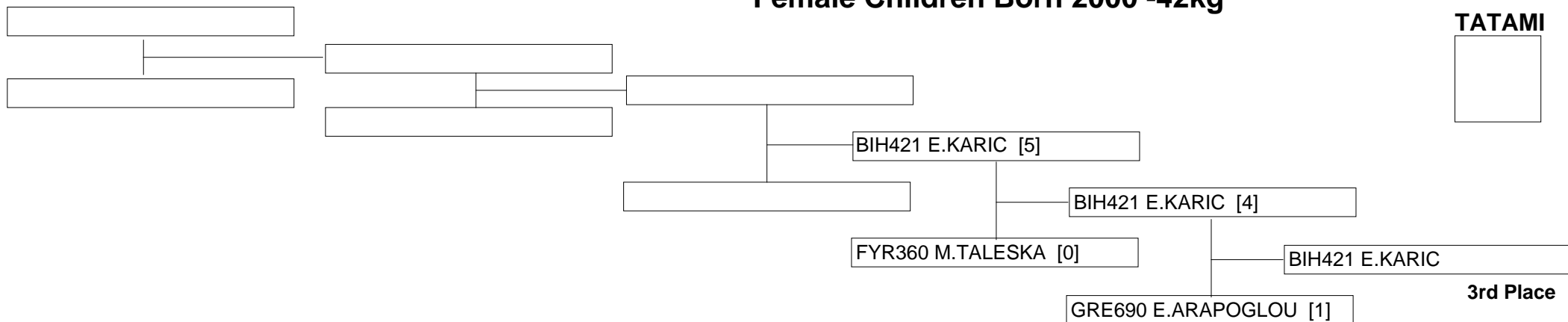



14th Balkan Cadet & Junior 3th U21 18th Children

SERBIA - Kragujevac

29/3/2013 - 31/3/2013

Entries: 23

Female Children Born 2000 -47kg

GRE592 K.XYLOURI [0]
SRB379 K.ZIVOVIC [7]
BUL304 I.GORANOVA []
<BYE>
FYR480 J.LUCHESKA [0]
BIH513 A.SAKANOVIC [8]
MNE313 D.KONATAR []
<BYE>
CYR274 N.THEOCHARIDOU []
BIH370 I.RAHMANOVIC [3]
FYR449 I.KOJOVSKA []
<BYE>
TUR795 O.GULER [3]
SRB528 D.TRIVUNOVIC [0]
HUN299 D.VEGH []
<BYE>
MNE305 A.DRAGOJEVIC [1]
GRE516 P.THEODORAKOPOU
FYR514 M.NIKOLOVSKA []
<BYE>
BIH436 B.MUNIKOZA [3]
TUR826 C.YILMAZ [0]
HUN286 A.DOZSA []
<BYE>
MNE346 I.KOVACEVIC [0]
GRE544 I.ALOURDA [2]
SRB366 S.SIMOVIC []
<BYE>
BUL307 Y.IVANOVA []
<BYE>
TUR814 N.SARA []
<BYE>

SRB379 K.ZIVOVIC [8]
SRB379 K.ZIVOVIC [4]
BUL304 I.GORANOVA [0]
SRB379 K.ZIVOVIC []
BIH513 A.SAKANOVIC [3]
BIH513 A.SAKANOVIC [0]
MNE313 D.KONATAR [0]
BIH370 I.RAHMANOVIC [6]
BIH370 I.RAHMANOVIC [6]
FYR449 I.KOJOVSKA [0]
BIH370 I.RAHMANOVIC []
TUR795 O.GULER [8]
TUR795 O.GULER [0]
HUN299 D.VEGH [0]
GRE516 P.THEODORAKOPOU
GRE516 P.THEODORAKOPOU
FYR514 M.NIKOLOVSKA [0]
BIH436 B.MUNIKOZA [8]
BIH436 B.MUNIKOZA [4]
BIH436 B.MUNIKOZA [4]
HUN286 A.DOZSA [1]
BIH436 B.MUNIKOZA [1]
GRE544 I.ALOURDA [0]
SRB366 S.SIMOVIC [3]
SRB366 S.SIMOVIC [8]
SRB366 S.SIMOVIC [0]
BUL307 Y.IVANOVA [2]
BUL307 Y.IVANOVA [1]
TUR814 N.SARA [1]

Pool 1

TATAMI



TATAMI

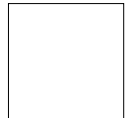

Pool 2

Female Children Born 2000 -47kg



14th Balkan Cadet & Junior 3th U21 18th Children

SERBIA - Kragujevac

29/3/2013 - 31/3/2013

Female Children Born 2000 -47kg

Repechage Pool 1

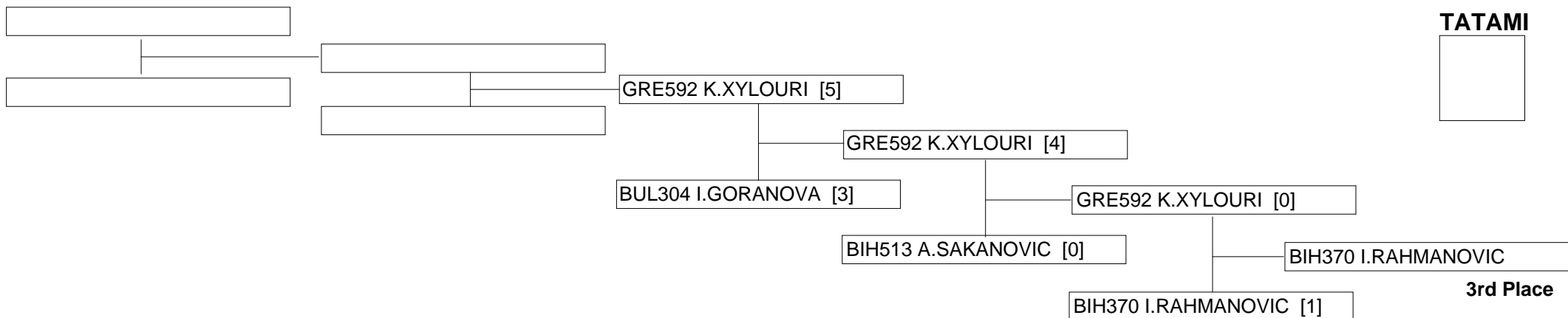

Repechage Pool 2

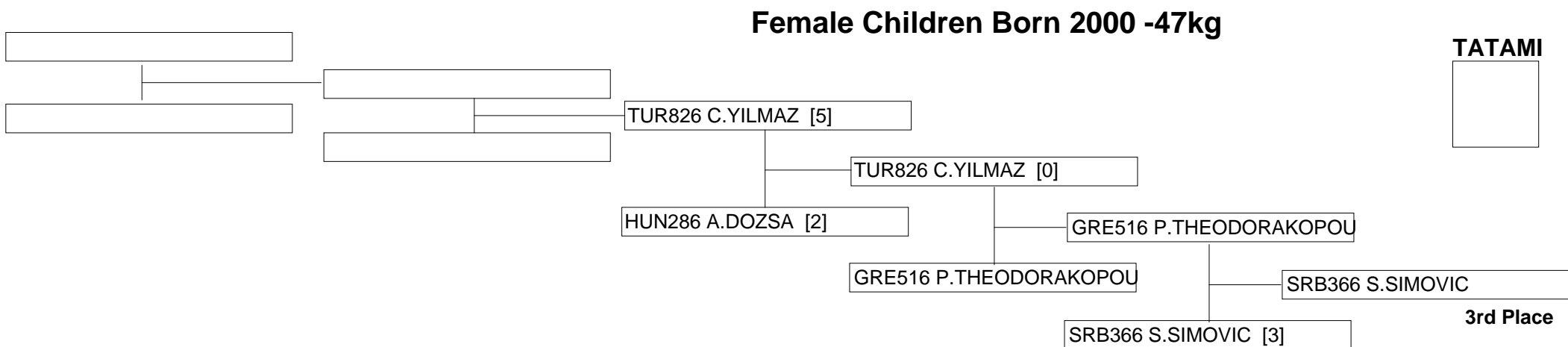



14th Balkan Cadet & Junior 3th U21 18th Children

SERBIA - Kragujevac

29/3/2013 - 31/3/2013

GRE570 F.MPATSILA [8]
HUN302 B.BORDAS [0]
MNE318 E.MARKIC []
<BYE>
SRB500 M.PLJUNCEVIC []
<BYE>
BIH477 D.KALAJDZIC []
<BYE>
GRE721 A.KARMANIOLA [0]
FYR497 V.GAFURI [9]
SRB519 T.STJEPANOVIC []
<BYE>
BIH357 D.MAHMUD []
<BYE>
BUL371 N.PETKOVA []
<BYE>
HUN294 D.PAP [8]
BIH471 N.HUSKIC [0]
GRE740 S.MANOLATOU []
<BYE>
FYR420 S.SIMOVSKA []
<BYE>
BUL369 N.PANTEVA []
<BYE>
SRB352 V.MIHAILOVIC []
<BYE>
FYR431 S.CVETKOSKA []
<BYE>
MNE344 I.GODEC []
<BYE>
TUR679 K.SEZGIN []
<BYE>

GRE570 F.MPATSILA [8]
GRE570 F.MPATSILA [8]
MNE318 E.MARKIC [0]
SRB500 M.PLJUNCEVIC [10]
SRB500 M.PLJUNCEVIC [0]
BIH477 D.KALAJDZIC [2]
FYR497 V.GAFURI [0]
SRB519 T.STJEPANOVIC [4]
SRB519 T.STJEPANOVIC [8]
BIH357 D.MAHMUD [1]
BIH357 D.MAHMUD [0]
BUL371 N.PETKOVA [0]
HUN294 D.PAP [3]
HUN294 D.PAP [3]
GRE740 S.MANOLATOU [2]
HUN294 D.PAP [0]
FYR420 S.SIMOVSKA [1]
FYR420 S.SIMOVSKA [0]
BUL369 N.PANTEVA [0]
SRB352 V.MIHAILOVIC [0]
FYR431 S.CVETKOSKA [0]
FYR431 S.CVETKOSKA [8]
MNE344 I.GODEC [0]
TUR679 K.SEZGIN [5]
TUR679 K.SEZGIN [5]

Female Children Born 2001 42+kg

Entries: 19

Pool 1

TATAMI

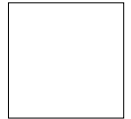

TATAMI

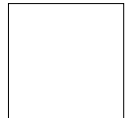

Pool 2

Female Children Born 2001 42+kg



14th Balkan Cadet & Junior 3th U21 18th Children

SERBIA - Kragujevac

29/3/2013 - 31/3/2013

Female Children Born 2001 42+kg

Repechage Pool 1

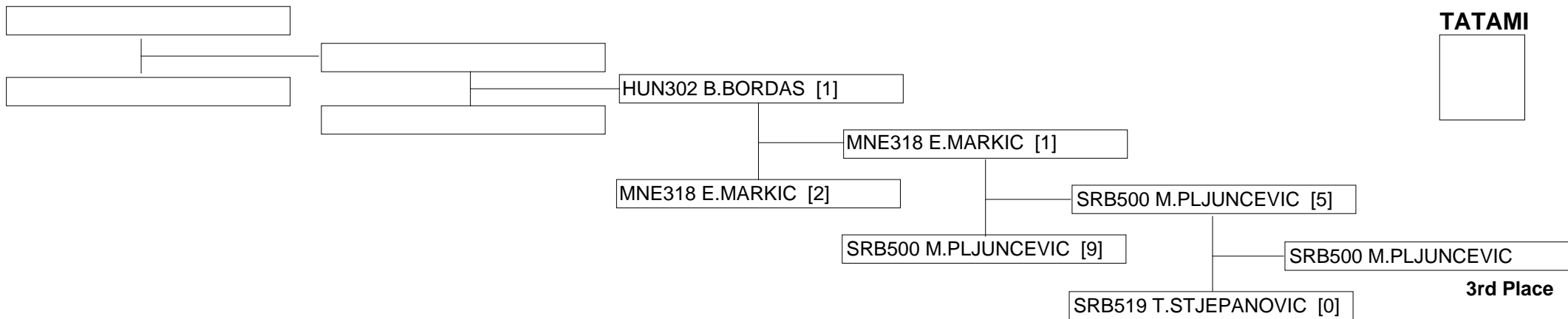

Repechage Pool 2

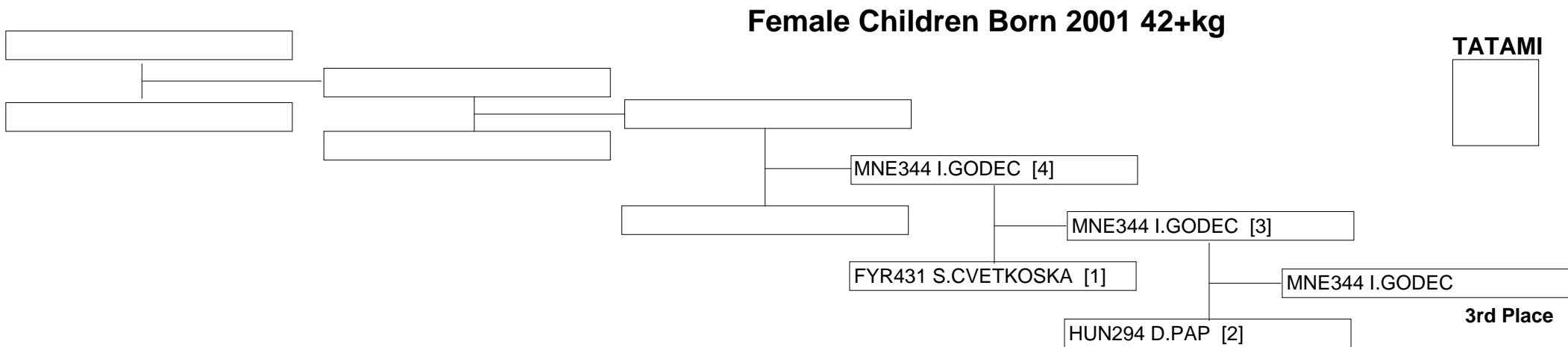



14th Balkan Cadet & Junior 3th U21 18th Children

SERBIA - Kragujevac

29/3/2013 - 31/3/2013

Female Children Born 2001 -37kg

Entries: 14

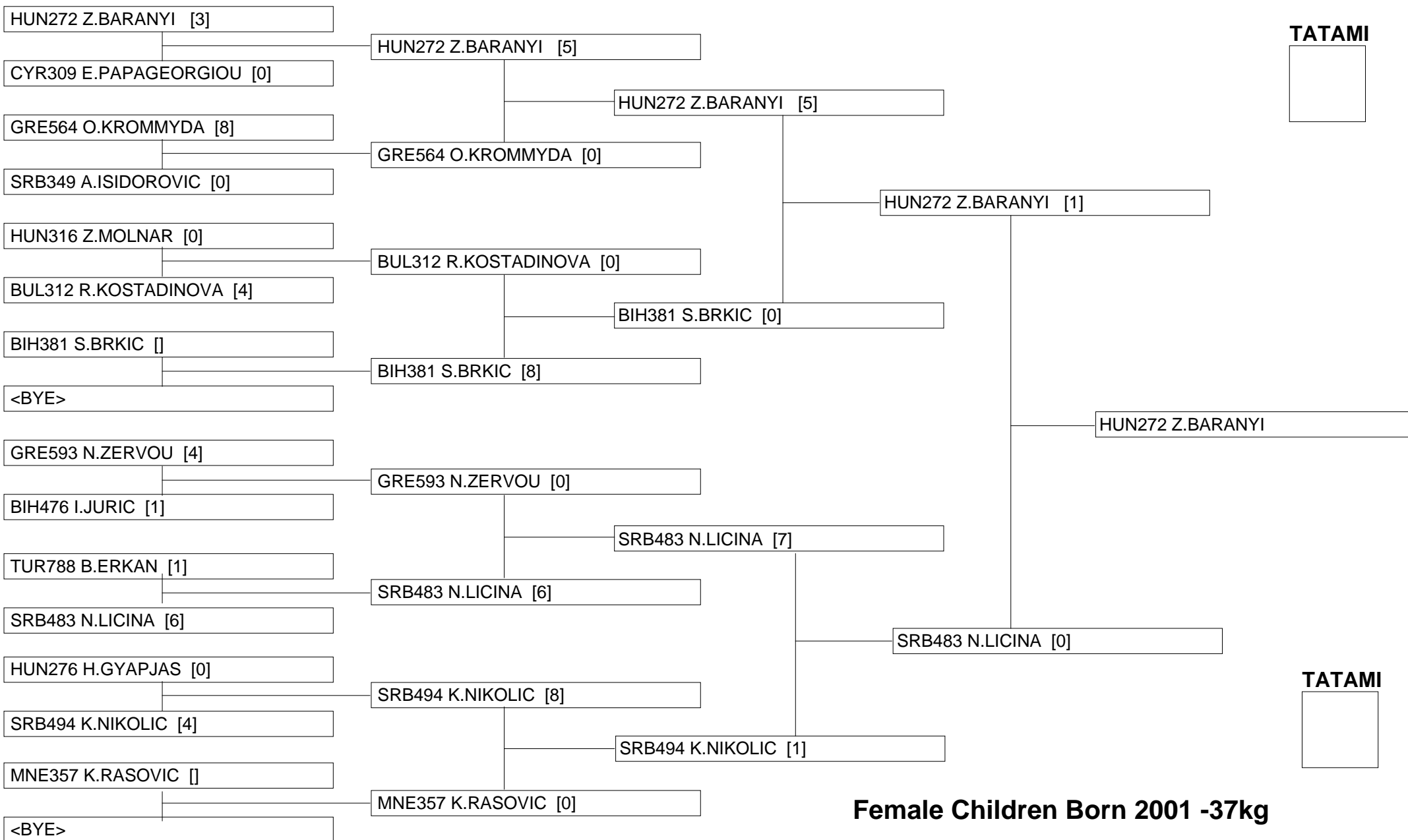

TATAMI

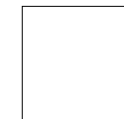

TATAMI



Female Children Born 2001 -37kg



14th Balkan Cadet & Junior 3th U21 18th Children

SERBIA - Kragujevac

29/3/2013 - 31/3/2013

Female Children Born 2001 -37kg

Repechage Pool 1

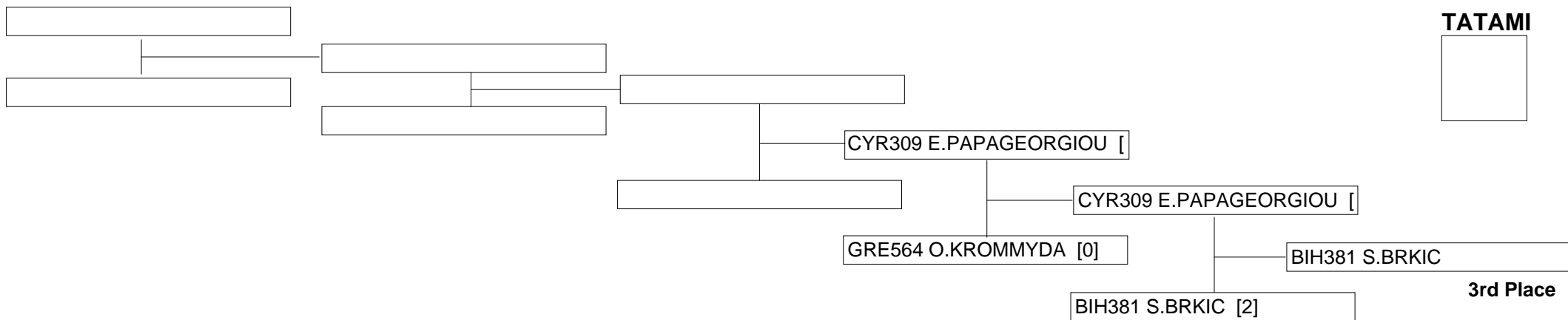

Repechage Pool 2

Female Children Born 2001 -37kg

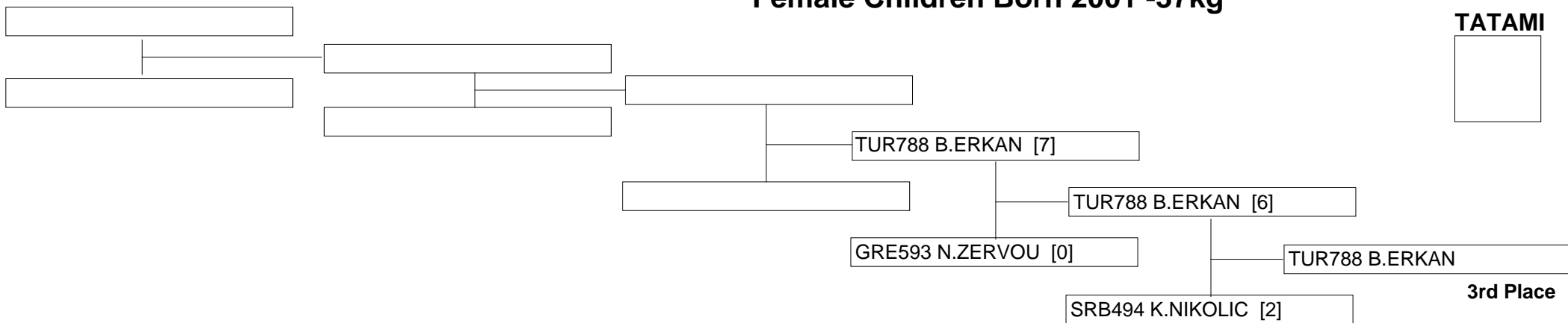



14th Balkan Cadet & Junior 3th U21 18th Children

SERBIA - Kragujevac

29/3/2013 - 31/3/2013

Female Children Born 2001 -42kg

Entries: 14

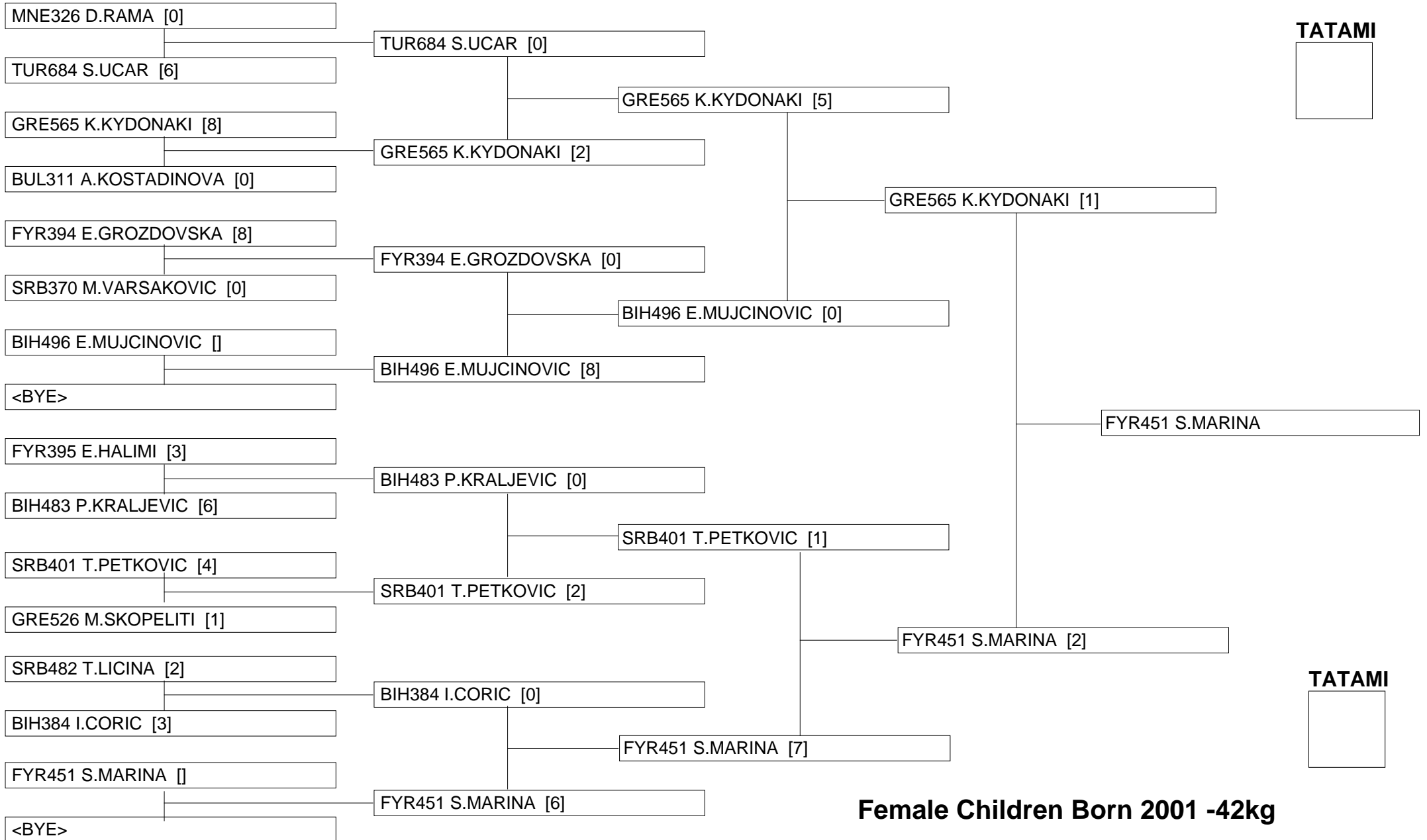

Female Children Born 2001 -42kg



14th Balkan Cadet & Junior 3th U21 18th Children

SERBIA - Kragujevac

29/3/2013 - 31/3/2013

Female Children Born 2001 -42kg

Repechage Pool 1

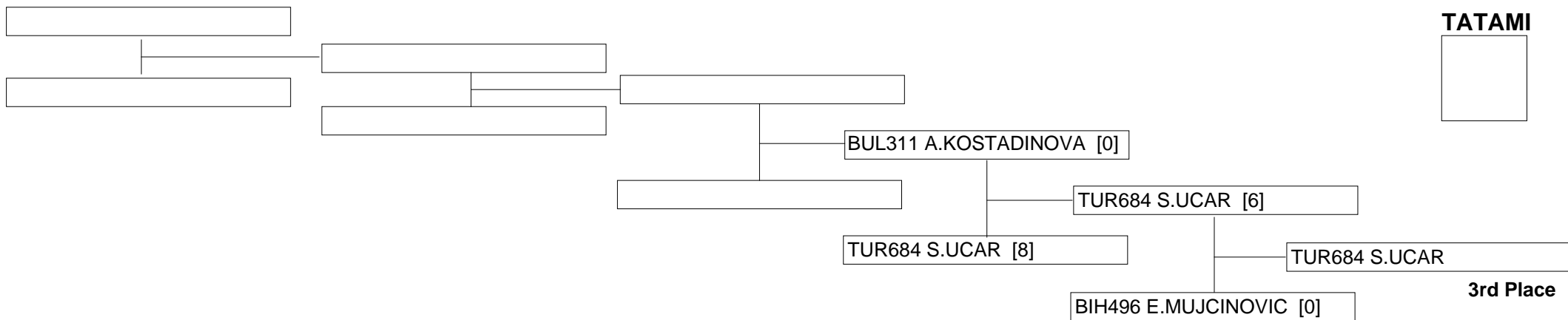

Repechage Pool 2

Female Children Born 2001 -42kg

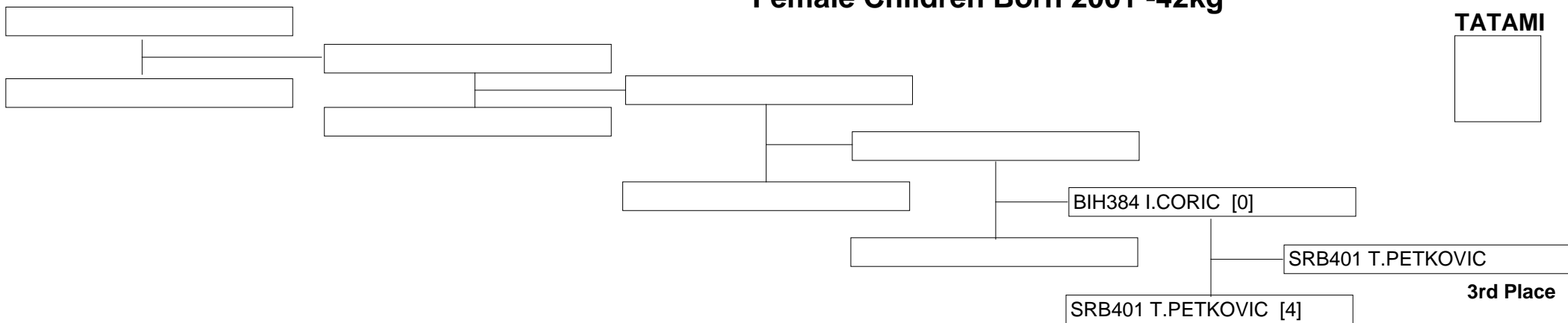



14th Balkan Cadet & Junior 3th U21 18th Children

SERBIA - Kragujevac

29/3/2013 - 31/3/2013

Female Children Born 2002 40+kg

Entries: 16

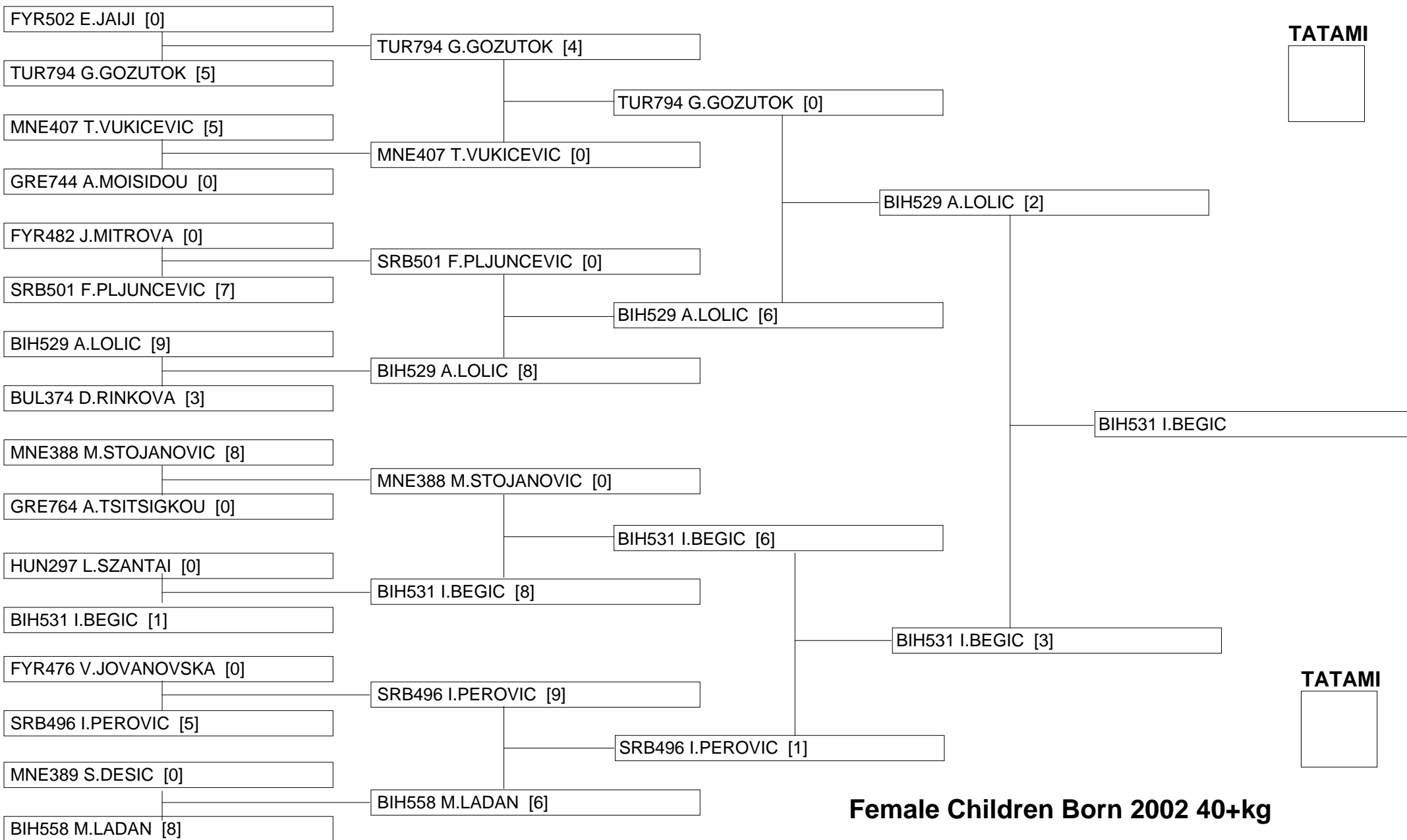

Female Children Born 2002 40+kg



14th Balkan Cadet & Junior 3th U21 18th Children

SERBIA - Kragujevac

29/3/2013 - 31/3/2013

Female Children Born 2002 40+kg

Repechage Pool 1

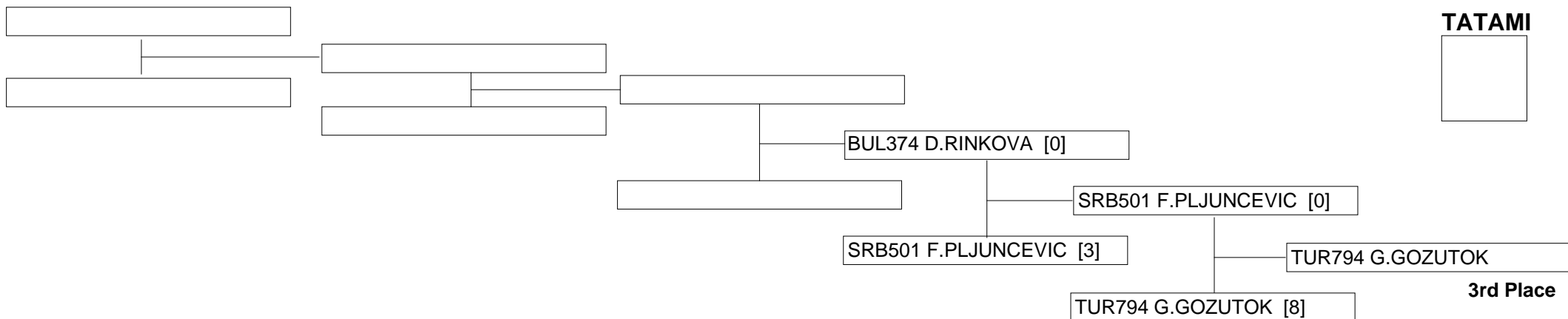

Repechage Pool 2

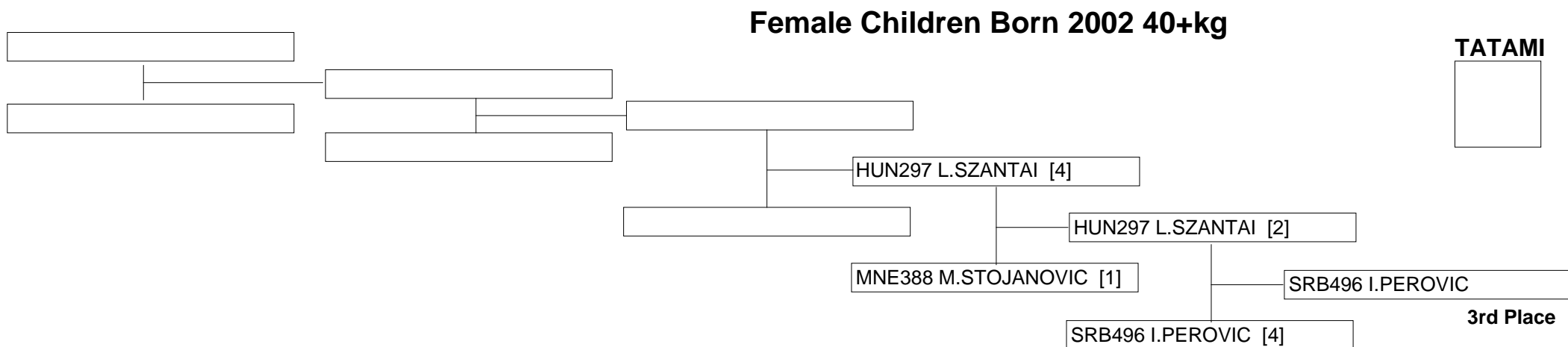



14th Balkan Cadet & Junior 3th U21 18th Children

SERBIA - Kragujevac

29/3/2013 - 31/3/2013

Female Children Born 2002 -35kg

Entries: 16

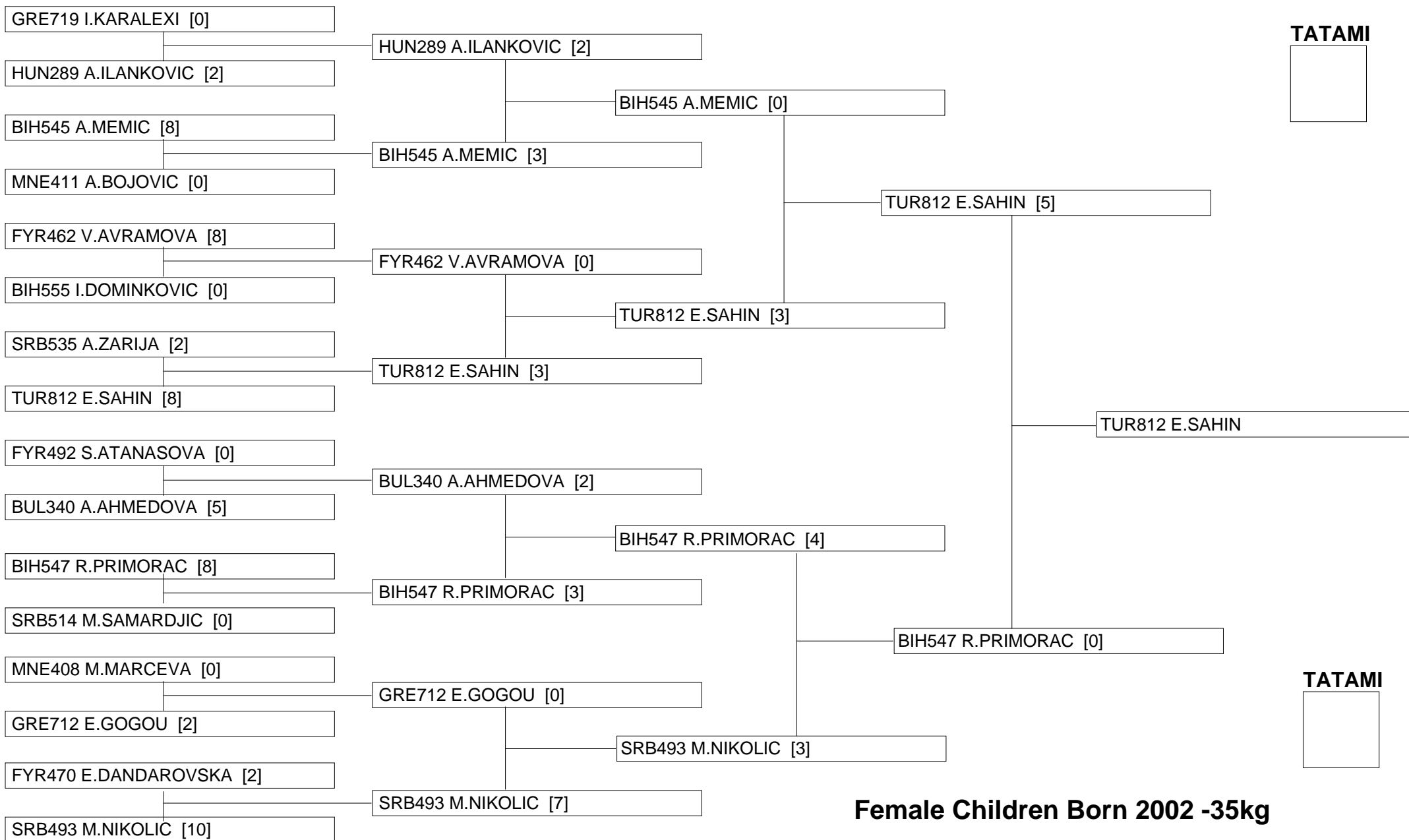

Female Children Born 2002 -35kg



14th Balkan Cadet & Junior 3th U21 18th Children

SERBIA - Kragujevac

29/3/2013 - 31/3/2013

Female Children Born 2002 -35kg

Repechage Pool 1

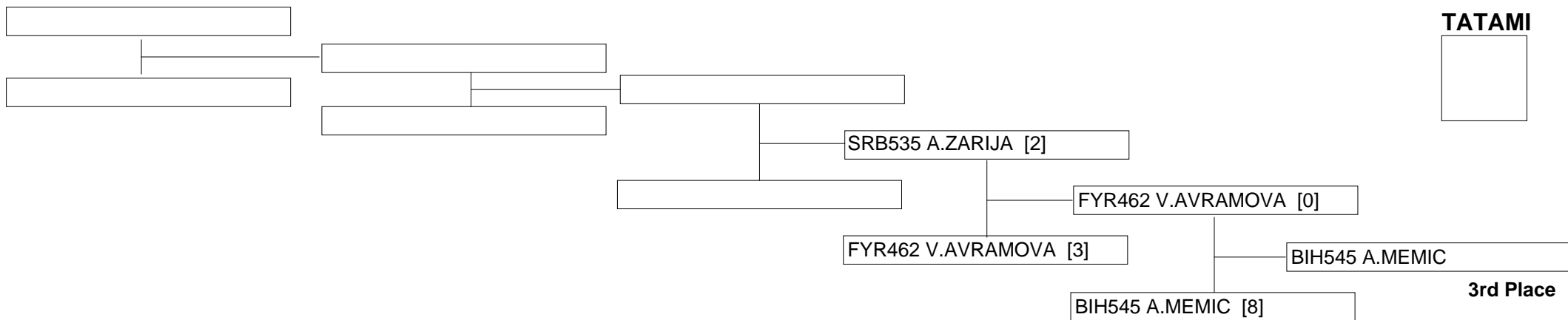

Repechage Pool 2

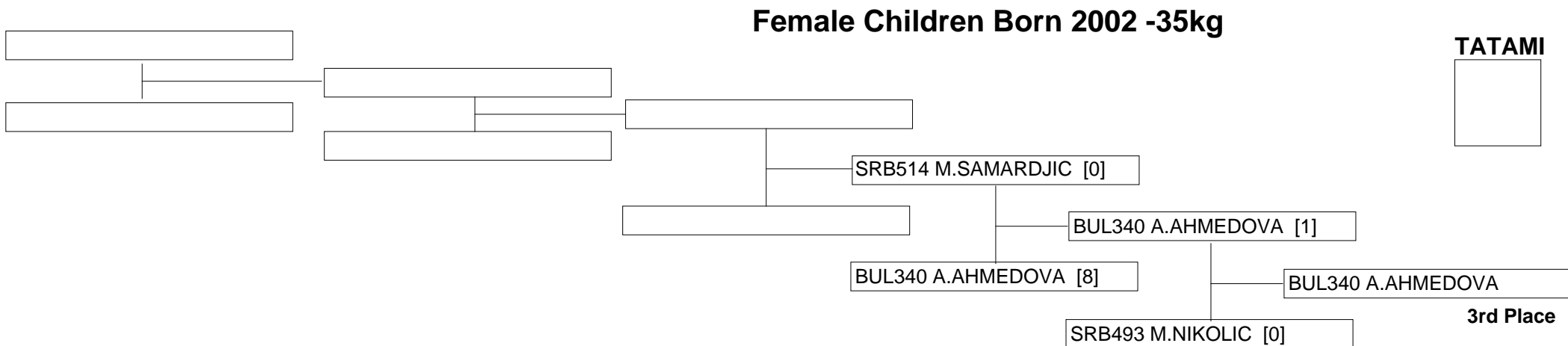



14th Balkan Cadet & Junior 3th U21 18th Children

SERBIA - Kragujevac

29/3/2013 - 31/3/2013

Female Children Born 2002 -40kg

Entries: 15

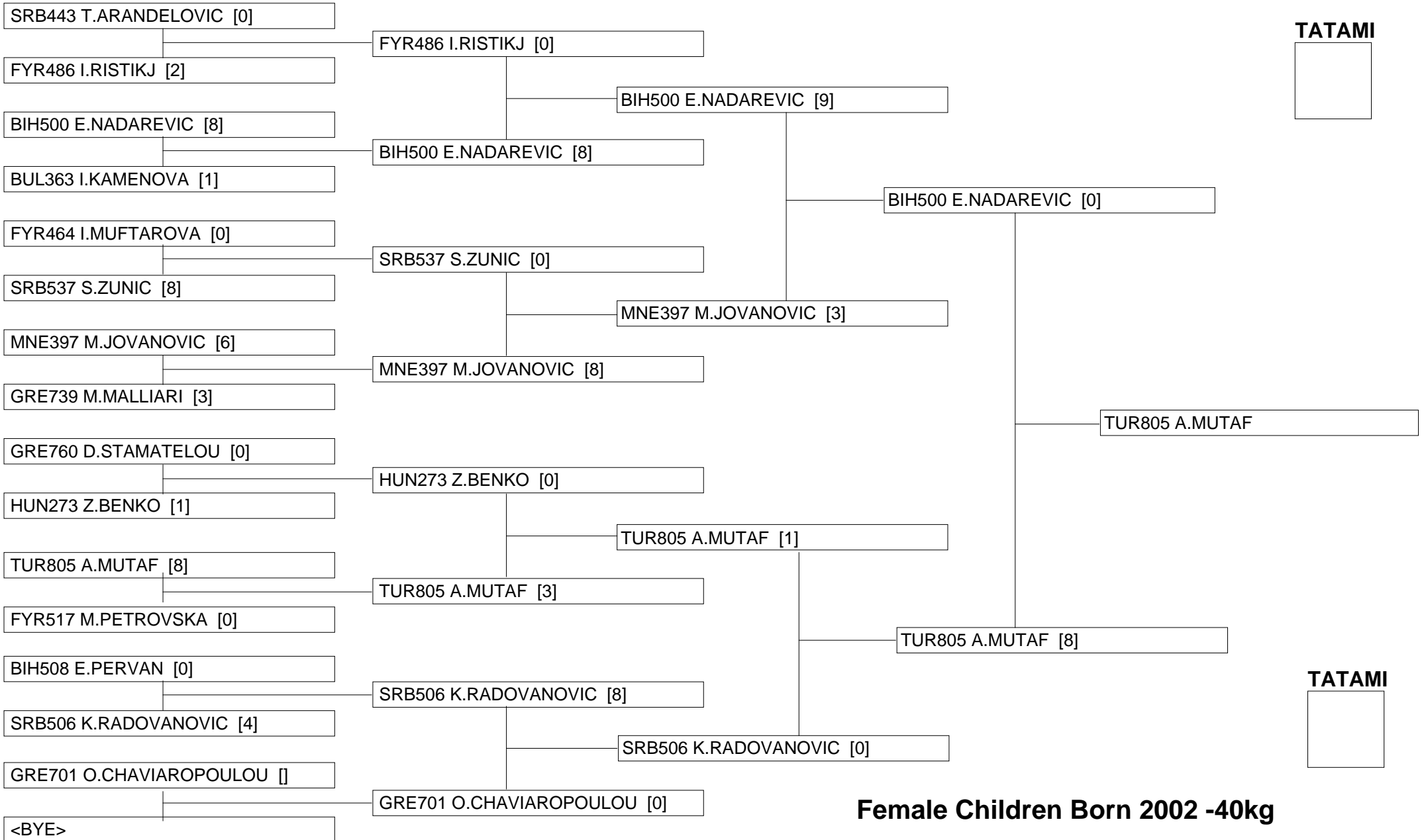

Female Children Born 2002 -40kg



14th Balkan Cadet & Junior 3th U21 18th Children

SERBIA - Kragujevac

29/3/2013 - 31/3/2013

Female Children Born 2002 -40kg

Repechage Pool 1

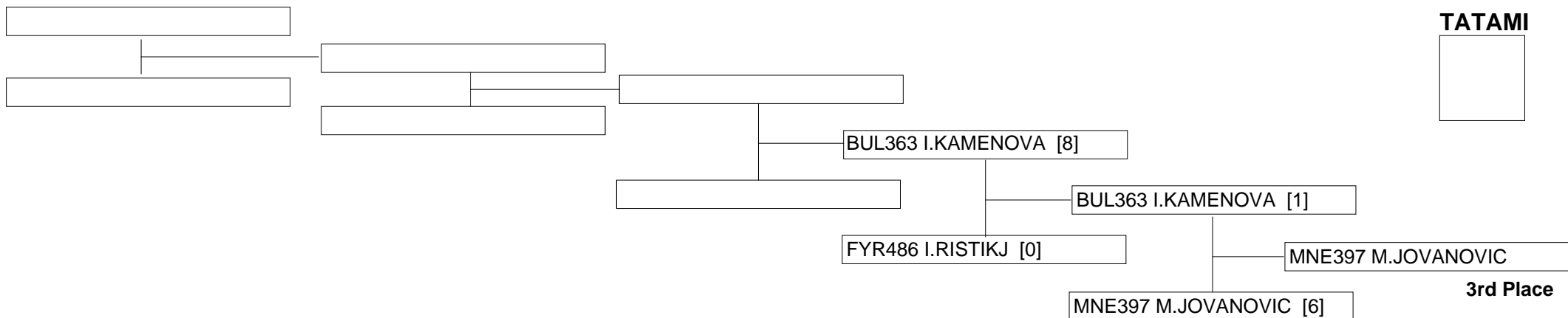

Repechage Pool 2

Female Children Born 2002 -40kg

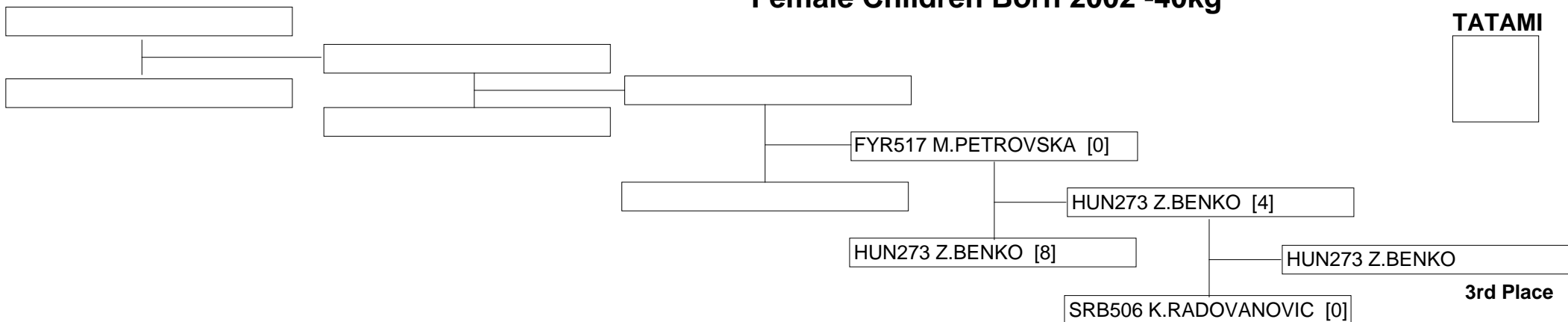



14th Balkan Cadet & Junior 3th U21 18th Children

SERBIA - Kragujevac

29/3/2013 - 31/3/2013

Cadet Kata Male

Entries: 23

BUL272 G.BRAYKOV []
FYR318 G.STANOEV []
MNE269 E.LUKOLIC []
<BYE>

FYR318 G.STANOEV [Gsh/Dai]

MNE269 E.LUKOLIC []

MNE269 E.LUKOLIC [Gsh/Sho]

SRB271 J.SIMIC []

SRB271 J.SIMIC [Kank Sho]
GRE466 A.KARAGKOUNIS [An]

SRB271 J.SIMIC [Gsh/Sho]

SRB271 J.SIMIC []

HUN255 G.HERMANN []
<BYE>

HUN255 G.HERMANN [Gojushi]

MNE201 B.ZECEVIC [Enpi]
BIH291 H.POLJO [Kank Sho]

MNE201 B.ZECEVIC [Gsh/Sho]

SRB327 L.GERGELJ []

SRB327 L.GERGELJ []
<BYE>

SRB327 L.GERGELJ [Kank Sh]

TUR744 F.KARABAG []

TUR744 F.KARABAG [Paiku]
BUL283 V.KOLESHANSKI [Sei/

TUR744 F.KARABAG [Nipaipo]

TUR744 F.KARABAG []

GRE379 M.PAPADOPETRAKIS
<BYE>

GRE379 M.PAPADOPETRAKIS

TUR744 F.KARABAG

BIH409 E.KARIC [Unsu]
ROM248 A.CRUCERU [Gsh/Sh]

ROM248 A.CRUCERU [Enpi]

BUL263 M.DINEV [Sei/chin]

BUL263 M.DINEV []
<BYE>

BUL263 M.DINEV [Seipai]

TUR757 C.KOCA [Bas Dai]

TUR757 C.KOCA [Gsh/Sho]
SRB259 L.BOGDANOVIC [Gsh]

TUR757 C.KOCA [Kank Sho]

TUR757 C.KOCA [Enpi]

GRE397 M.TSIGAS []
<BYE>

GRE397 M.TSIGAS [Unshu]

TUR635 E.GOKTAS [Unsu]

BIH308 B.BABAJIC [Gsh/Sho]
HUN260 M.BAKO [Sanseru]

BIH308 B.BABAJIC [Enpi]

MNE200 I.ZECEVIC [Kank Sho]

MNE200 I.ZECEVIC []
<BYE>

MNE200 I.ZECEVIC [Gsh/Sho]

TUR635 E.GOKTAS [Kank Sho]

TUR635 E.GOKTAS []
<BYE>

TUR635 E.GOKTAS [Enpi]

TUR635 E.GOKTAS [Gsh/Sho]

CYR203 A.PAPANDREOU []
<BYE>

CYR203 A.PAPANDREOU [Un]

Cadet Kata Male

Pool 1

TATAMI

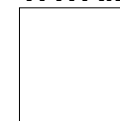

TATAMI

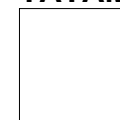

Pool 2



14th Balkan Cadet & Junior 3th U21 18th Children

SERBIA - Kragujevac

29/3/2013 - 31/3/2013

Cadet Kata Male

Repechage Pool 1

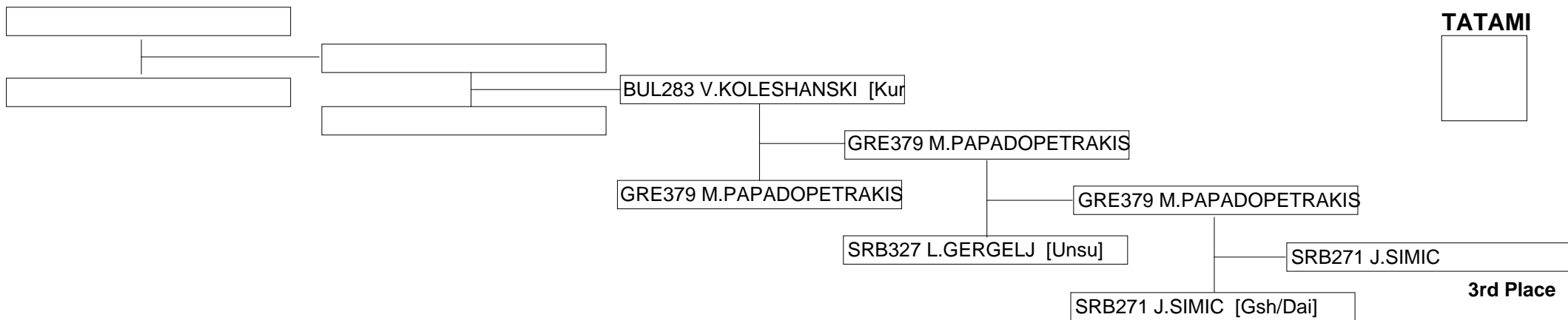

Repechage Pool 2

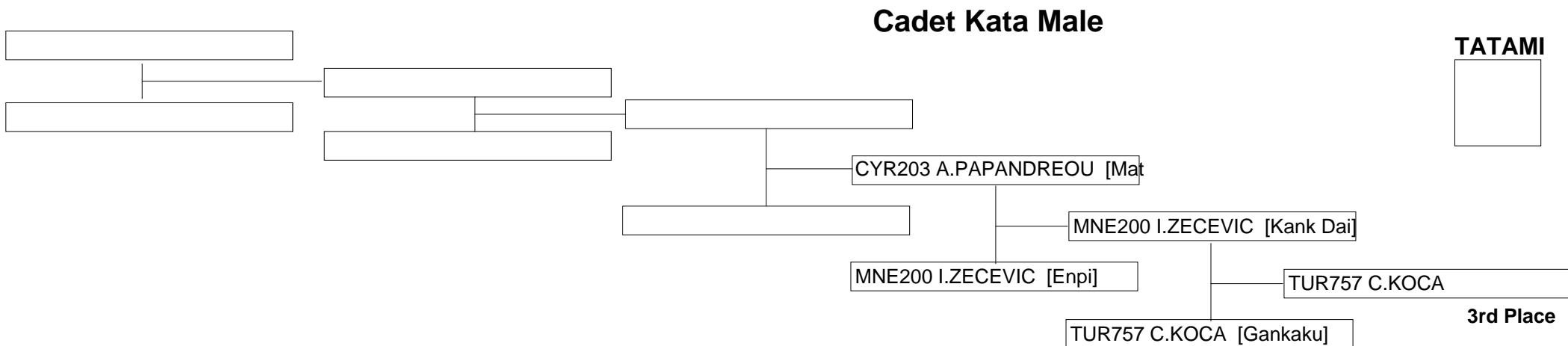



14th Balkan Cadet & Junior 3th U21 18th Children

SERBIA - Kragujevac

29/3/2013 - 31/3/2013

Cadet Kata Female

Entries: 19

SRB418 V.GAJINOVIC [Jion]
BIH468 A.HECIMOVIĆ [Unsu]
TUR634 D.ATAK []
<BYE>
GRE382 A.ROUCHOTA []
<BYE>
FYR330 M.DIMOSKA []
<BYE>
HUN247 A.GYENES [Annan]
GRE365 M.BOURA [Hakucho]
CYR216 M.GEORGIOU []
<BYE>
BIH365 S.ORASCANIN []
<BYE>
MNE199 T.RADUNOVIC []
<BYE>
GRE308 G.XENOU [Annan]
MNE220 S.JOVANOVIC [Gsh/
TUR573 M.MAZLUM []
<BYE>
SRB316 A.MARKUSEV []
<BYE>
HUN249 V.HIEBER []
<BYE>
MNE191 J.SIMONOVIC []
<BYE>
FYR329 M.DIMOSKA []
<BYE>
SRB322 A.GAGIC []
<BYE>
BIH307 A.BASIC []
<BYE>



Pool 1

TATAMI

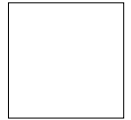

TATAMI

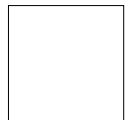

Pool 2

Cadet Kata Female



14th Balkan Cadet & Junior 3th U21 18th Children

SERBIA - Kragujevac

29/3/2013 - 31/3/2013

Cadet Kata Female

Repechage Pool 1

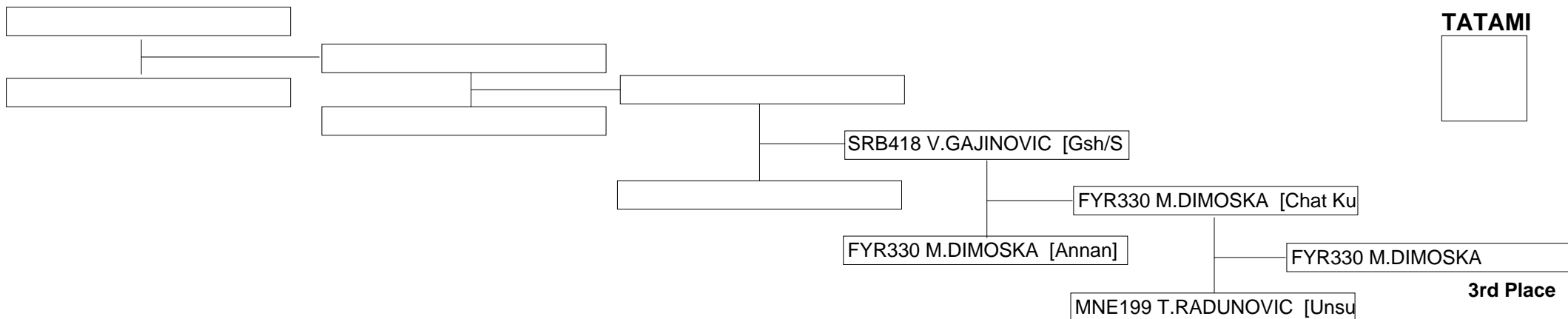

Repechage Pool 2

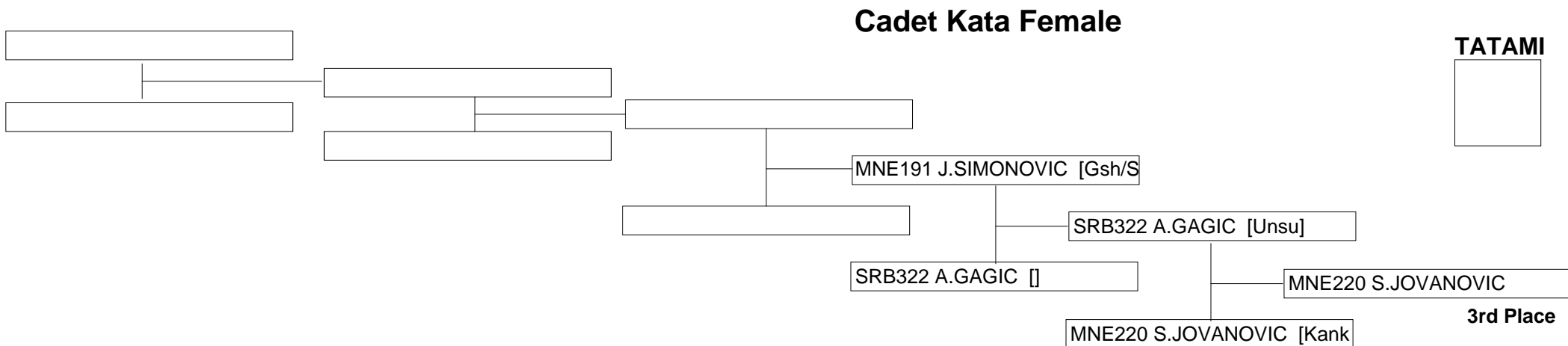



14th Balkan Cadet & Junior 3th U21 18th Children

SERBIA - Kragujevac

29/3/2013 - 31/3/2013

Junior Kata Male

Entries: 20

- GRE372 S.HASAPIS [Enpi]
- TUR516 F.SELMAN [Gsh/Sho]
- SLO245 A.KLANECEK []
- <BYE>
- FYR336 A.STOJANOSKI []
- <BYE>
- BIH519 S.SULJIC []
- <BYE>
- HUN226 S.KOCH [Sei/chin]
- FYR319 M.RISTOVSKI [Gsh/D]
- SRB467 M.JOVOVIC []
- <BYE>
- TUR551 O.EVIN []
- <BYE>
- BIH316 N.TOPIC []
- <BYE>
- HUN228 P.MIHALY [Seipai]
- CYR193 C.NICOLAOU [Sup/m]
- SRB477 J.KSTIC []
- <BYE>
- MNE192 S.VUKOVIC []
- <BYE>
- TUR560 M.OZTURK []
- <BYE>
- HUN304 K.FEDOR [Seisan]
- BIH501 A.NIKOLIC [Jion]
- SRB426 D.SRDJEVIC []
- <BYE>
- GRE362 A.POLICHRONOS []
- <BYE>
- FYR273 V.BESLIEV []
- <BYE>

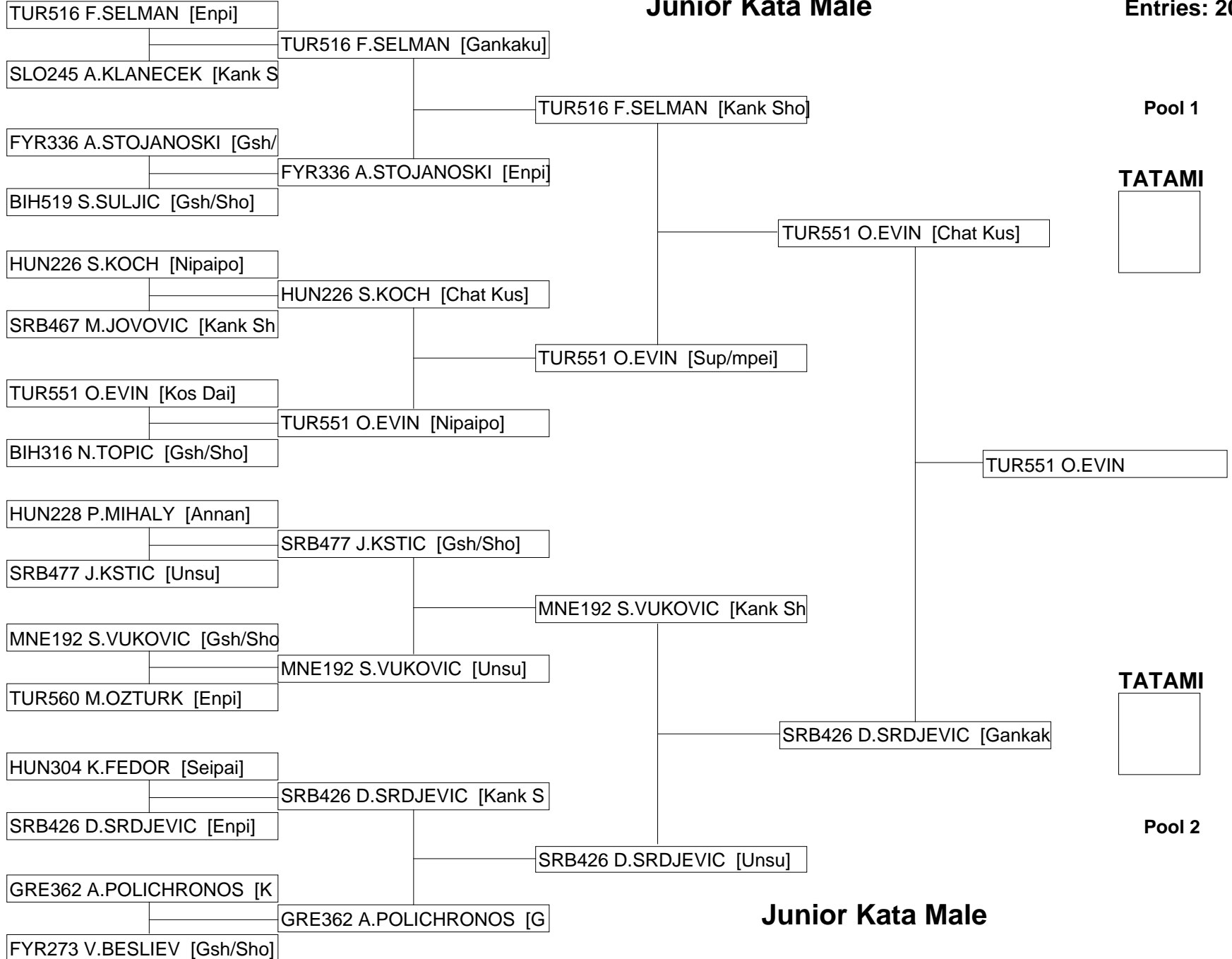

Junior Kata Male



14th Balkan Cadet & Junior 3th U21 18th Children

SERBIA - Kragujevac

29/3/2013 - 31/3/2013

Junior Kata Male

Repechage Pool 1

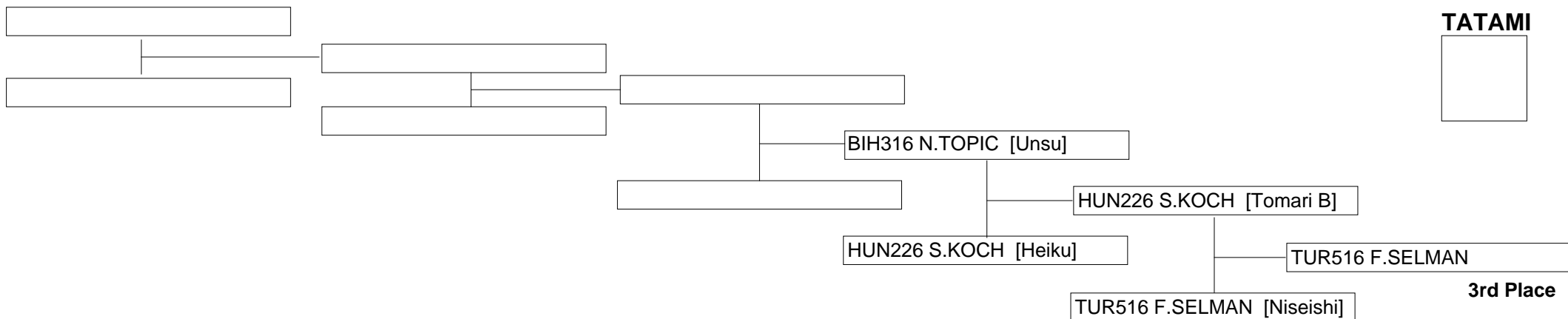

Repechage Pool 2

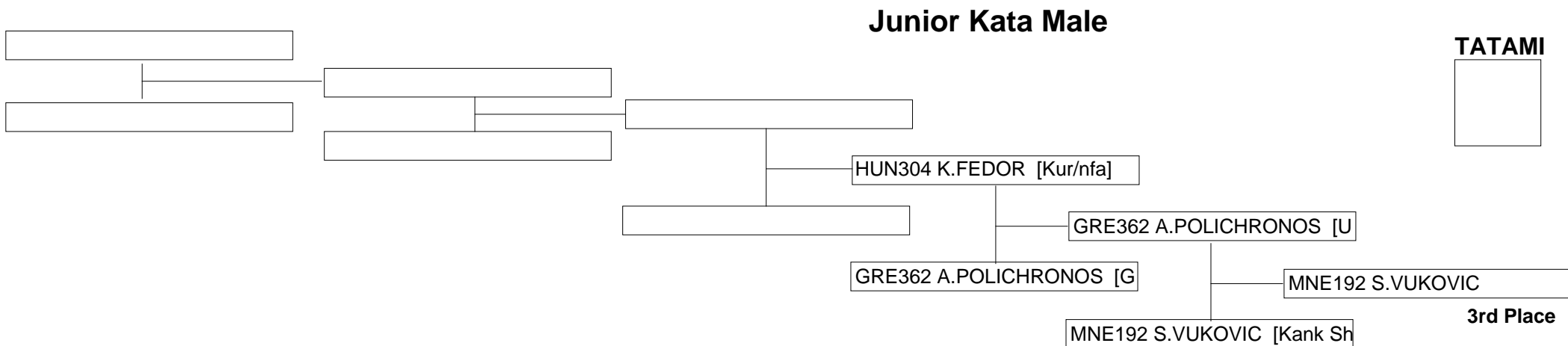



14th Balkan Cadet & Junior 3th U21 18th Children

SERBIA - Kragujevac

29/3/2013 - 31/3/2013

Junior Kata Female

Entries: 19

FYR263 N.GJORGJEVIK [Gsh/
GRE726 S.KOLIOU [Seipai]
BIH552 A.SUHONIC []
<BYE>
HUN214 L.STERCK []
<BYE>
SRB284 V.SAVEVSKI []
<BYE>
SRB283 J.LEKOVIC []
MNE404 A.RAMOVIC []
FYR334 M.VOJDINOVSKA []
<BYE>
TUR528 H.KIRATLI []
<BYE>
BUL217 M.HRISTOVA []
<BYE>
HUN320 D.ZBORAY [Nipaipo]
MNE369 A.SLJUKIC [Gsh/Sho]
BIH305 Z.BEKTAS []
<BYE>
BUL238 S.VANGELOVA []
<BYE>
GRE318 E.BYROU []
<BYE>
BIH506 A.PENAVA []
<BYE>
TUR494 I.SAHIN []
<BYE>
FYR332 N.MATRAKOSKA []
<BYE>
SRB260 B.MLADEZIC []
<BYE>

FYR263 N.GJORGJEVIK [Gsh/
SRB260 B.MLADEZIC [Kank
BIH552 A.SUHONIC [Gsh/Sho]
SRB284 V.SAVEVSKI [Gsh/Sh]
HUN214 L.STERCK [Sup/mpei]
SRB284 V.SAVEVSKI [Unsu]
SRB284 V.SAVEVSKI [Kank Sh
SRB283 J.LEKOVIC [Sei/chin]
SRB283 J.LEKOVIC [Kank Sho]
FYR334 M.VOJDINOVSKA [Sei
TUR528 H.KIRATLI [Sup/mpei]
TUR528 H.KIRATLI [Annan]
TUR528 H.KIRATLI [Chat Kus]
BUL217 M.HRISTOVA [Sup/mp
MNE369 A.SLJUKIC [Enpi]
BIH305 Z.BEKTAS [Gsh/Sho]
BIH305 Z.BEKTAS [Kank Sho]
BUL238 S.VANGELOVA [Pass]
BUL238 S.VANGELOVA []
BUL238 S.VANGELOVA [Kush]
GRE318 E.BYROU []
BUL238 S.VANGELOVA [Kush]
BIH506 A.PENAVA []
TUR494 I.SAHIN [Chat Kus]
TUR494 I.SAHIN []
FYR332 N.MATRAKOSKA []
SRB260 B.MLADEZIC [Kank S
SRB260 B.MLADEZIC [Kank S
SRB260 B.MLADEZIC []

SRB284 V.SAVEVSKI [Gsh/Sh]

TUR528 H.KIRATLI [Gojushih]

SRB260 B.MLADEZIC

BUL238 S.VANGELOVA [Pass]

SRB260 B.MLADEZIC [Gankak]

SRB260 B.MLADEZIC [Unsu]

Junior Kata Female

Pool 1

TATAMI

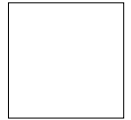

TATAMI

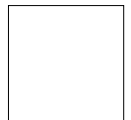

Pool 2



14th Balkan Cadet & Junior 3th U21 18th Children

SERBIA - Kragujevac

29/3/2013 - 31/3/2013

Junior Kata Female

Repechage Pool 1

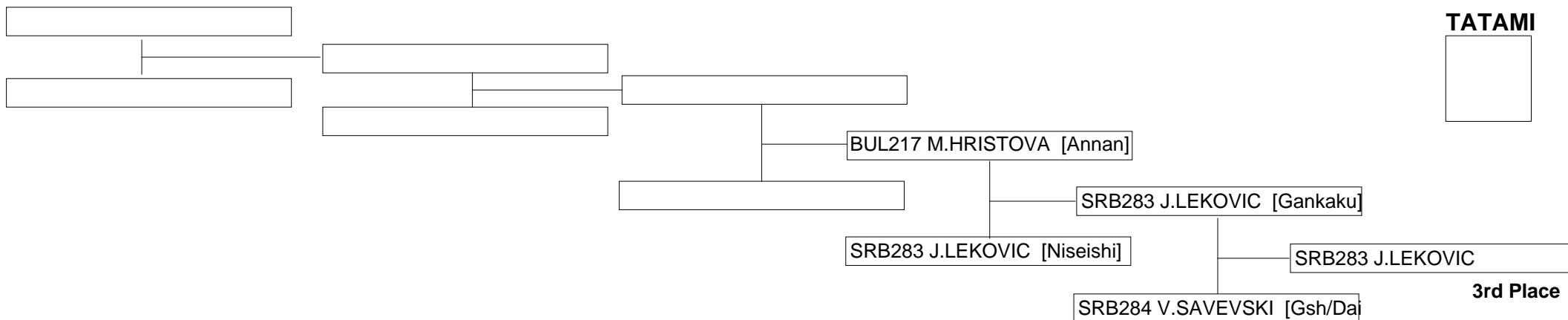

Repechage Pool 2

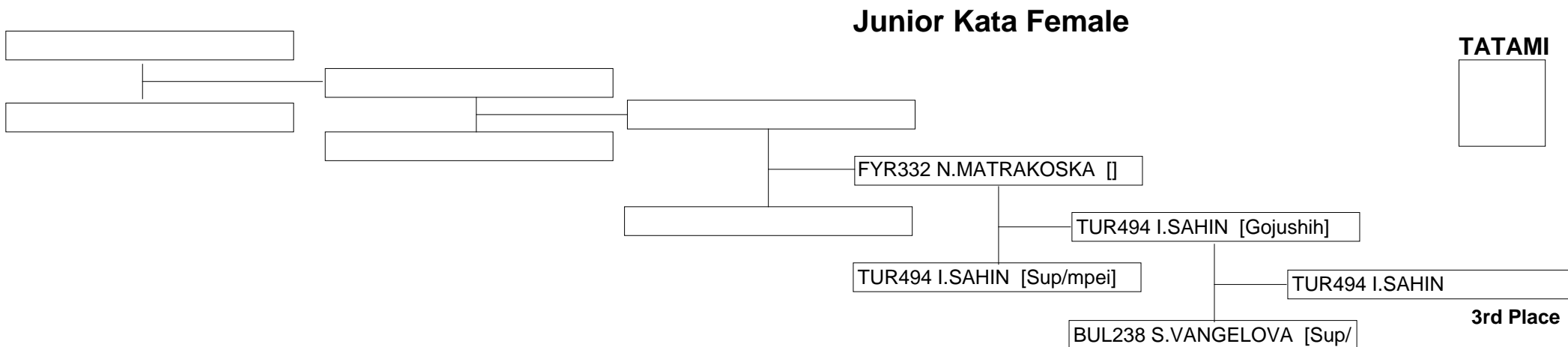



14th Balkan Cadet & Junior 3th U21 18th Children

SERBIA - Kragujevac

29/3/2013 - 31/3/2013

Cadet/Junior Team Kata Male

Entries: 5

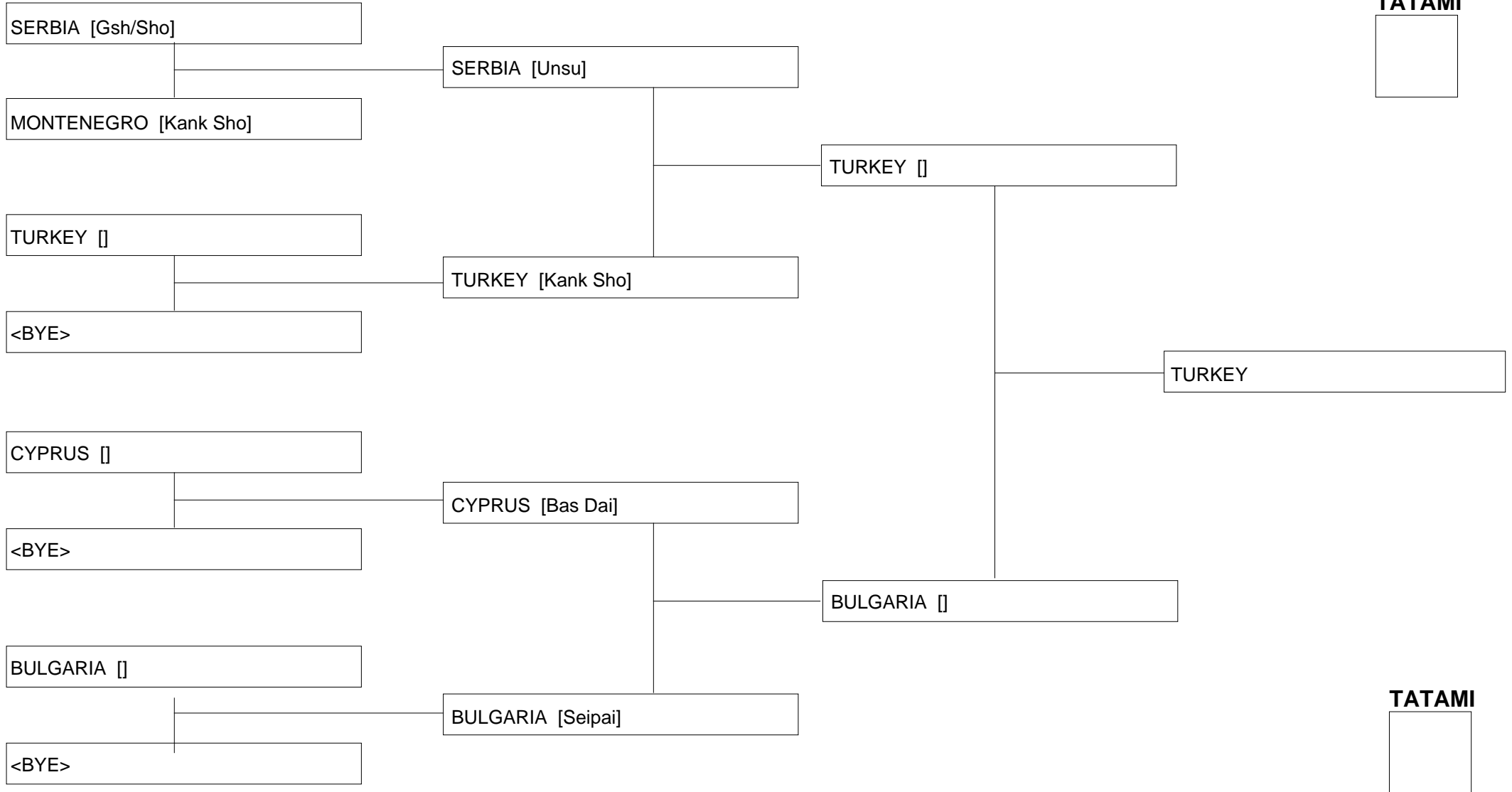

Cadet/Junior Team Kata Male



14th Balkan Cadet & Junior 3th U21 18th Children

SERBIA - Kragujevac

29/3/2013 - 31/3/2013

Cadet/Junior Team Kata Male

Repechage Pool 1

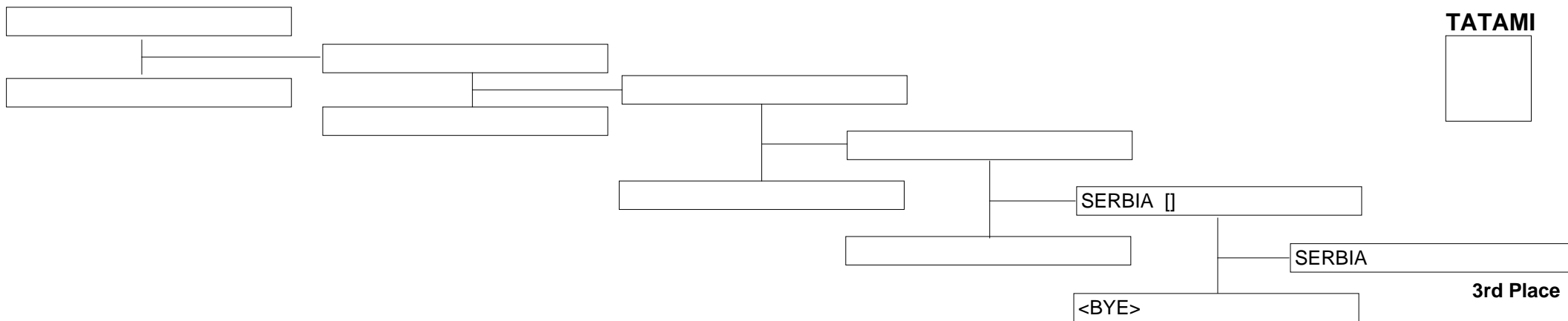

Repechage Pool 2

Cadet/Junior Team Kata Male

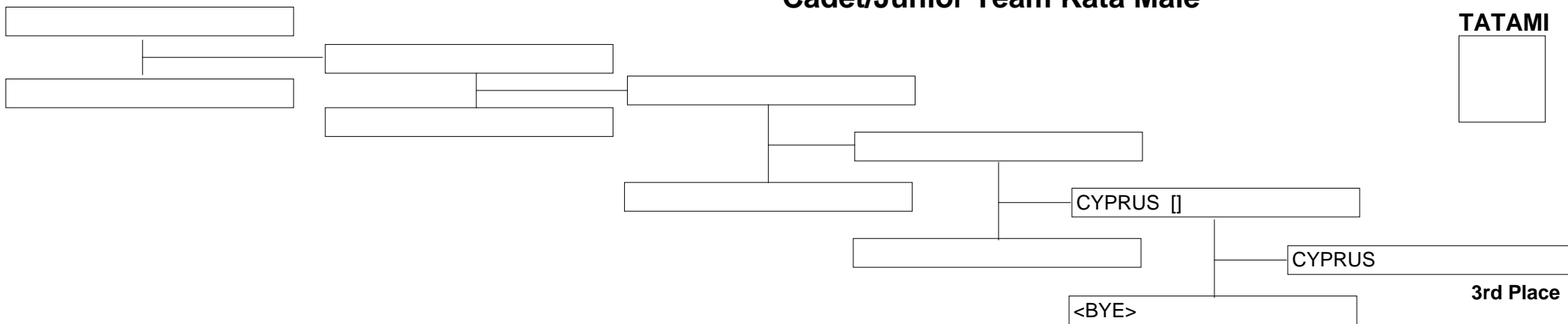



14th Balkan Cadet & Junior 3th U21 18th Children

SERBIA - Kragujevac

29/3/2013 - 31/3/2013

Cadet/Junior Team Kata Female

Entries: 6

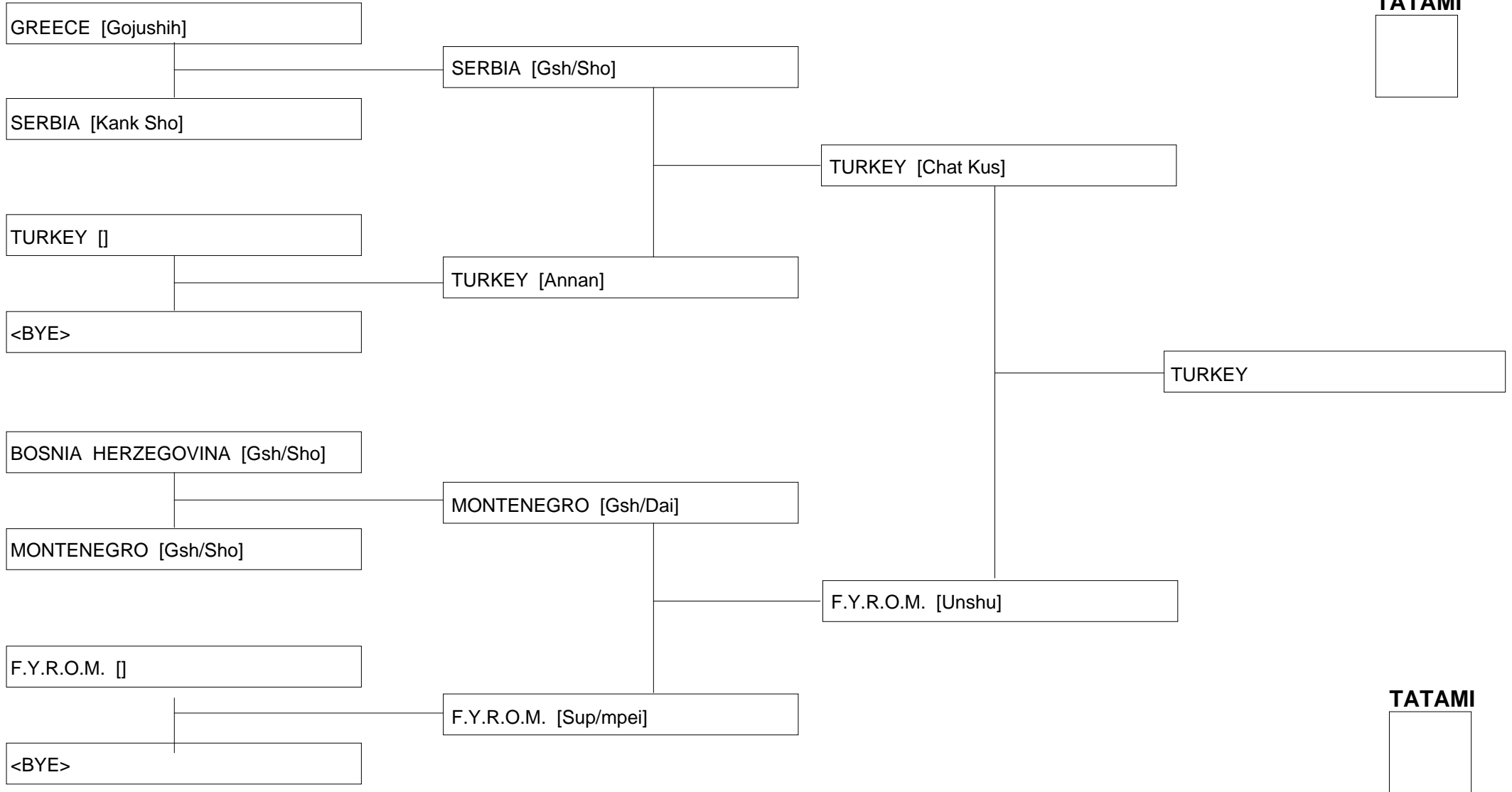

TATAMI

TATAMI

Cadet/Junior Team Kata Female



14th Balkan Cadet & Junior 3th U21 18th Children

SERBIA - Kragujevac

29/3/2013 - 31/3/2013

Cadet/Junior Team Kata Female

Repechage Pool 1

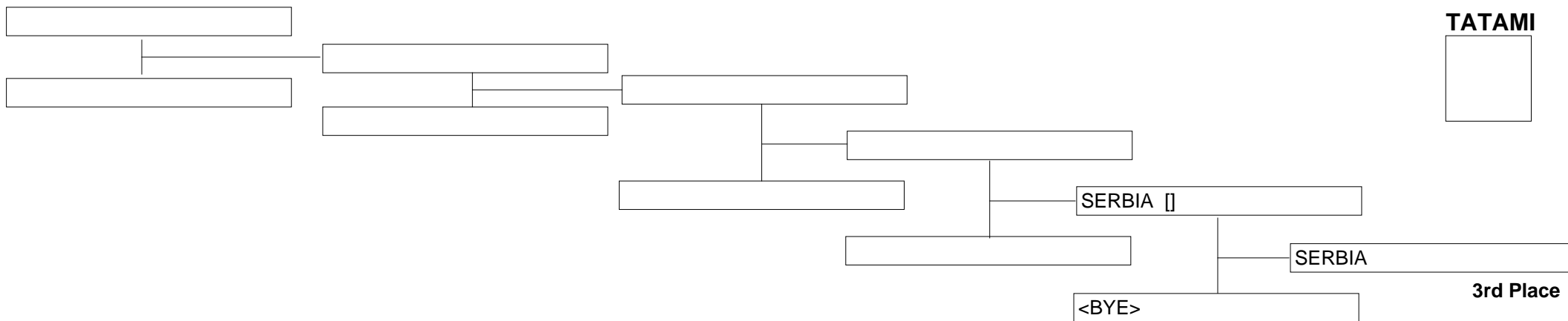

Repechage Pool 2

Cadet/Junior Team Kata Female





14th Balkan Cadet & Junior 3th U21 18th Children

SERBIA - Kragujevac

29/3/2013 - 31/3/2013

Cadet Kumite Male 70+ kg

Entries: 20

SLO276 A.FILIC [0]
TUR756 M.KABASAKAL [8]
SRB461 O.JERKOV []
<BYE>
GRE383 G.STYLIANOPOULOS
<BYE>
FYR401 A.RISTESKI []
<BYE>
GRE476 N.BOGIANNIDIS [0]
TUR711 K.YILMAZ [2]
BIH281 A.VATRIC []
<BYE>
MNE193 N.LEKIC []
<BYE>
HUN309 A.HONING []
<BYE>
TUR755 H.INCE [3]
HUN265 E.CSATO [1]
GRE344 M.KATSIMBRIS []
<BYE>
BIH560 D.CAUSEVIC []
<BYE>
BUL246 A.ALITCHKAY []
<BYE>
HUN285 B.BILISICS [0]
BIH561 M.TADIC [8]
SRB420 B.OBRADOVIC []
<BYE>
MNE227 K.VUJOSEVIC []
<BYE>
CRO358 J.BUNJEVAC []
<BYE>



Pool 1

TATAMI



TATAMI

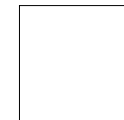

Pool 2

Cadet Kumite Male 70+ kg



14th Balkan Cadet & Junior 3th U21 18th Children

SERBIA - Kragujevac

29/3/2013 - 31/3/2013

Cadet Kumite Male 70+ kg

Repechage Pool 1

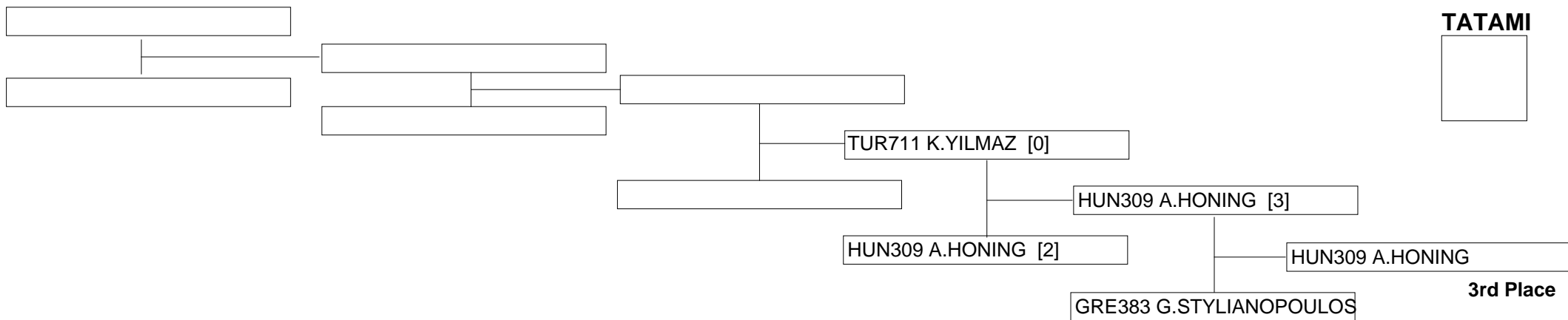

Repechage Pool 2

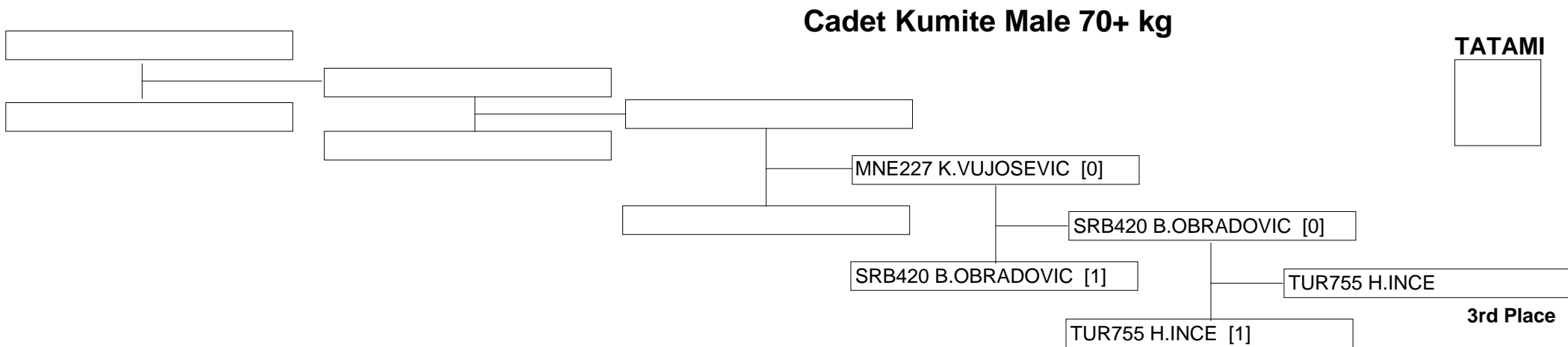



14th Balkan Cadet & Junior 3th U21 18th Children

SERBIA - Kragujevac

29/3/2013 - 31/3/2013

Cadet Kumite Male -52 kg

Entries: 26

HUN238 L.KOVACS [0]
TUR694 O.BAYIRLI [2]
SRB424 V.PUCAR [1]
ROM220 V.PAMFIL [7]
MNE375 L.KNEZEVIC [1]
BUL263 M.DINEV [3]
BIH487 M.LAZIC []
<BYE>
ROM248 A.CRUCERU [0]
BIH291 H.POLJO [6]
CRO387 L.KONDIC []
<BYE>
MNE342 N.DULOVIC [2]
SLO272 A.SUSIC [1]
GRE398 A.KOTTIAS DIMKOPO
<BYE>
BIH510 H.PESKIC [0]
HUN318 P.SZOLLOSI [5]
CYR203 A.PAPANDREOU [0]
GRE731 S.KOUMERTAS [10]
TUR751 R.ATES [8]
SRB436 I.STANKOV [0]
BUL242 V.YORDANOV []
<BYE>
HUN222 O.HAVASI [0]
TUR754 S.HUSNU [9]
ROM272 I.DUMITRACHE []
<BYE>
GRE755 O.SENTOUKAS [0]
MNE222 B.COLOVIC [3]
SRB353 M.MIHAILOVIC []
<BYE>



Pool 1

TATAMI



TATAMI

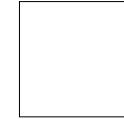

Pool 2

Cadet Kumite Male -52 kg



14th Balkan Cadet & Junior 3th U21 18th Children

SERBIA - Kragujevac

29/3/2013 - 31/3/2013

Cadet Kumite Male -52 kg

Repechage Pool 1

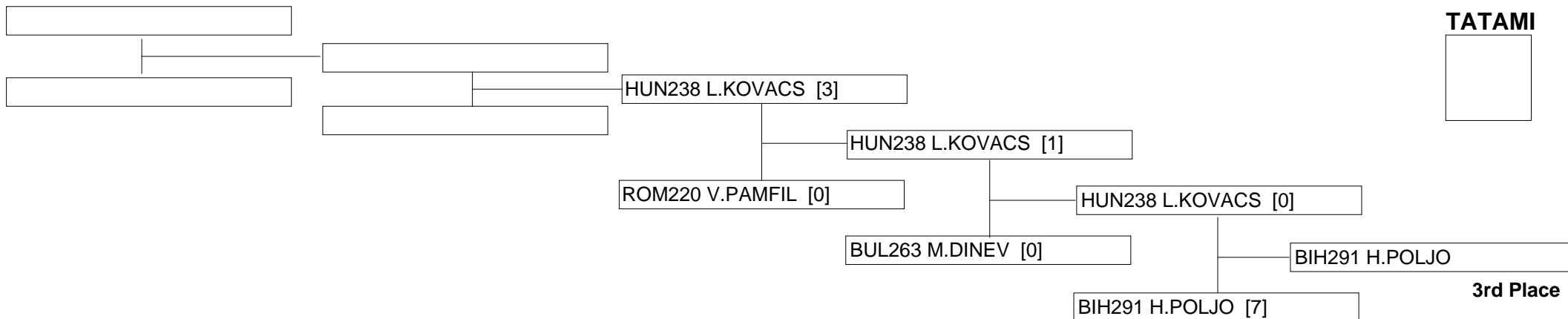

Repechage Pool 2

Cadet Kumite Male -52 kg

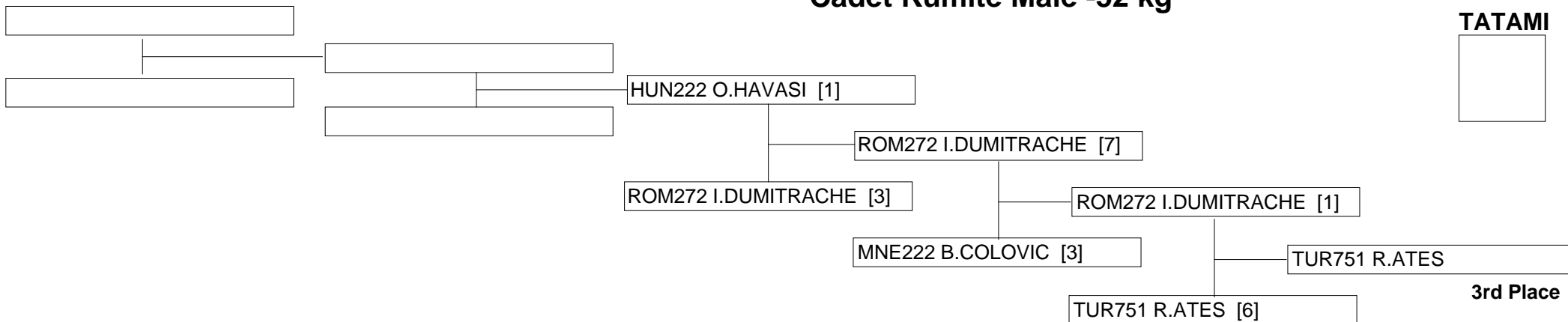



14th Balkan Cadet & Junior 3th U21 18th Children

SERBIA - Kragujevac

29/3/2013 - 31/3/2013

Cadet Kumite Male -57 kg

Entries: 26

SRB433 N.MANCEV [4]
TUR695 S.BINGOL [2]
GRE480 T.KANELIDIS [8]
ALB152 S.RARANI [0]
BIH431 S.ILIC [0]
HUN280 D.HUBNER [5]
FYR505 M.JOVANOV []
<BYE>
GRE443 V.GIAKOUMIDIS [2]
CRO388 I.LULIC [1]
BUL349 K.ATANASOV []
<BYE>
BIH310 M.BRKIC [3]
MNE378 B.LAZAREVIC [0]
HUN232 D.SZILAGYI []
<BYE>
MNE245 D.POPOVIC [0]
GRE673 V.VROUTSIS [3]
BIH470 J.HUSEJINOVIC [3]
SRB430 I.IZGARIJAN [1]
TUR745 A.KORKMAZ [6]
ROM271 M.DUMITRACHE [0]
CRO384 V.GASPAR []
<BYE>
HUN254 B.ARDAI [4]
SRB435 D.MUJANOVIC [0]
ALB177 J.MUCA []
<BYE>
CRO390 A.SAHINI [0]
MNE205 M.HODZIC [5]
FYR430 S.APOSTOLOVSKI []
<BYE>



Pool 1

TATAMI



TATAMI

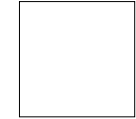

Pool 2

Cadet Kumite Male -57 kg



14th Balkan Cadet & Junior 3th U21 18th Children

SERBIA - Kragujevac

29/3/2013 - 31/3/2013

Cadet Kumite Male -57 kg

Repechage Pool 1

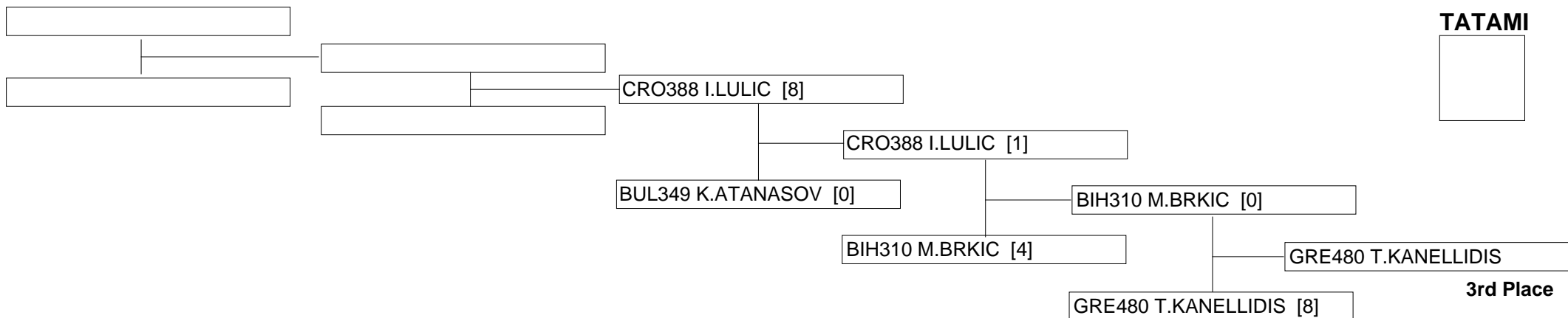

Repechage Pool 2

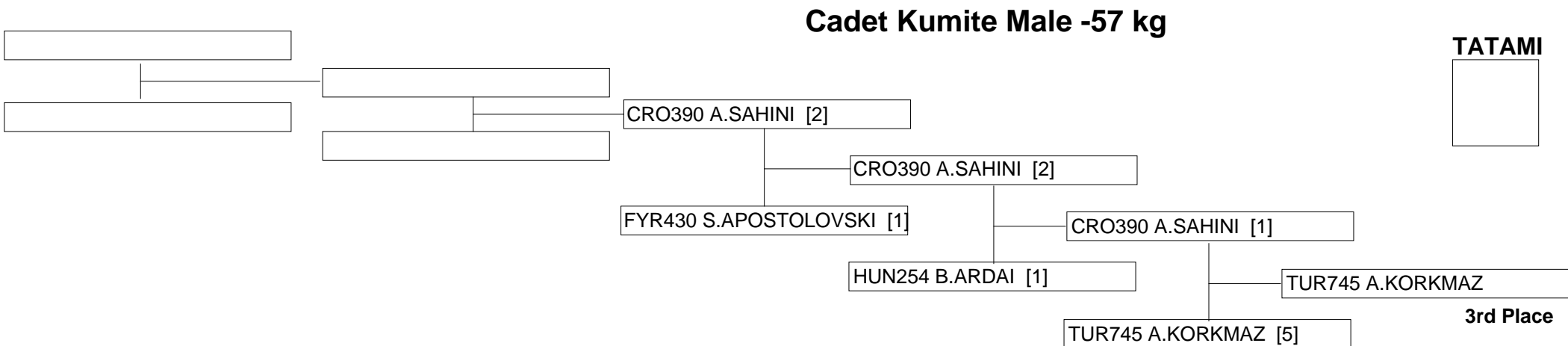



14th Balkan Cadet & Junior 3th U21 18th Children

SERBIA - Kragujevac

29/3/2013 - 31/3/2013

Cadet Kumite Male -63 kg

Entries: 26

HUN248 D.POZDERKA [4]
MNE237 S.MEDENICA [1]
BUL282 H.VATEV [7]
GRE377 G.KARALIS [3]
TUR680 A.TAYLAN [1]
CRO369 S.STIMAC [0]
BIH303 V.CAPIN []
<BYE>
CRO386 B.KATAVIC [2]
HUN279 F.TAMAS [1]
BIH411 G.MARIC []
<BYE>
SRB296 F.STOJAN [1]
FYR340 D.OSMANI [2]
ALB171 B.KEPUTA []
<BYE>
GRE433 K.KIRLOGLOU [5]
TUR753 F.GUMUS [2]
ALB161 R.MUCOLLARI [3]
BUL272 G.BRAYKOV [6]
SRB261 S.DJORDJE [11]
HUN303 B.BORZI [3]
MNE410 R.MINIC []
<BYE>
CRO362 A.HOVAN [0]
GRE442 N.CHRISTOU [3]
TUR803 M.KOR []
<BYE>
BIH539 N.HASANBEGOVIC [6]
SRB449 M.CACIC [5]
FYR473 D.ILIEVSKI []
<BYE>





14th Balkan Cadet & Junior 3th U21 18th Children

SERBIA - Kragujevac

29/3/2013 - 31/3/2013

Cadet Kumite Male -63 kg

Repechage Pool 1

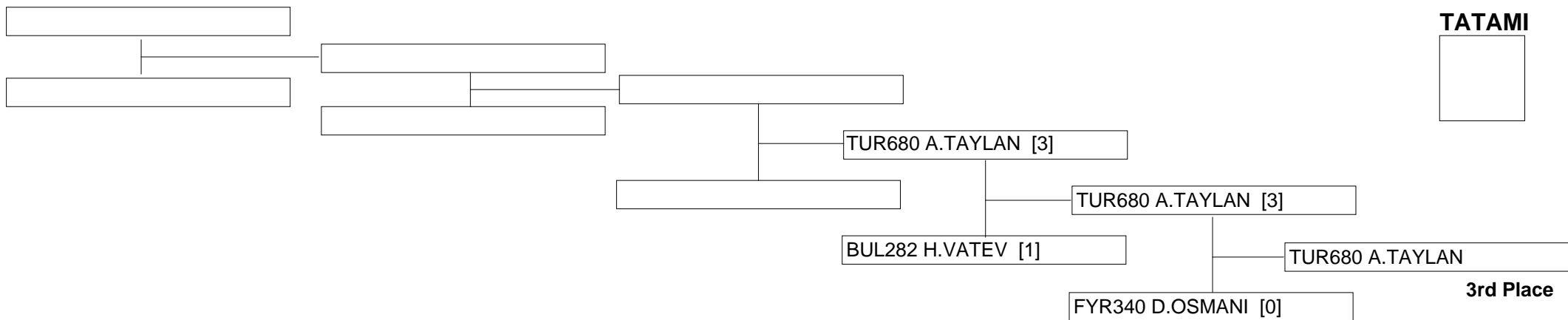

Repechage Pool 2

Cadet Kumite Male -63 kg

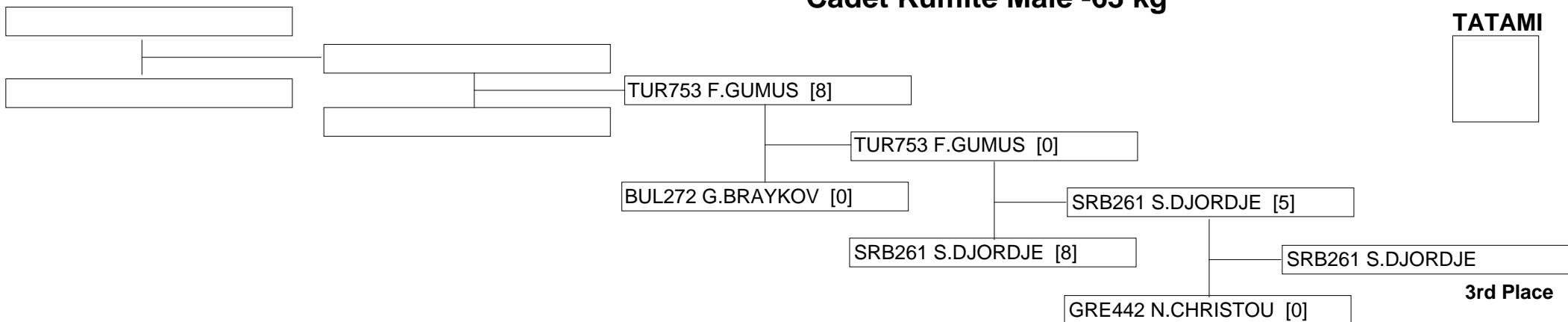



14th Balkan Cadet & Junior 3th U21 18th Children

SERBIA - Kragujevac

29/3/2013 - 31/3/2013

Cadet Kumite Male -70 kg

Entries: 23

AUT252 A.GRATZER [2]
FYR534 P.ZABORSKI [1]
TUR726 I.ALKAN []
<BYE>
BIH535 M.DJOZIC [9]
BUL253 K.SREDOV [3]
SRB356 M.PEPIC []
<BYE>
FYR276 A.MEHMED [8]
BIH484 M.KRALJEVIC [0]
ROM264 B.ALEXE []
<BYE>
MNE217 L.IVANOVIC [1]
CYR195 M.STYLIANOU [2]
GRE484 A.KARANATSIOS []
<BYE>
MNE278 V.POPOVIC [7]
SRB445 P.BAJIC [1]
TUR759 B.TOMBUL []
<BYE>
GRE749 I.PAPADOPOULOS [8]
BUL283 V.KOLESHANSKI [0]
FYR284 E.LUSLANI []
<BYE>
BUL370 P.PAVLOV [1]
GRE469 A.LITOS [7]
BIH517 M.SISIC []
<BYE>
CRO391 D.SARAC []
<BYE>
SRB406 M.MLADENOVIC []
<BYE>

AUT252 A.GRATZER [4]
AUT252 A.GRATZER [3]
TUR726 I.ALKAN [0]
BIH535 M.DJOZIC [5]
BIH535 M.DJOZIC [3]
SRB356 M.PEPIC [0]
FYR276 A.MEHMED [0]
ROM264 B.ALEXE [0]
ROM264 B.ALEXE [8]
CYR195 M.STYLIANOU [8]
CYR195 M.STYLIANOU [8]
GRE484 A.KARANATSIOS [0]
MNE278 V.POPOVIC [8]
MNE278 V.POPOVIC [3]
TUR759 B.TOMBUL [0]
GRE749 I.PAPADOPOULOS [6]
GRE749 I.PAPADOPOULOS [4]
FYR284 E.LUSLANI [3]
GRE469 A.LITOS [6]
GRE469 A.LITOS [2]
BIH517 M.SISIC [1]
GRE469 A.LITOS [3]
CRO391 D.SARAC [1]
CRO391 D.SARAC [1]
SRB406 M.MLADENOVIC [0]

AUT252 A.GRATZER [1]
BIH535 M.DJOZIC [3]
AUT252 A.GRATZER [4]
ROM264 B.ALEXE [0]
CYR195 M.STYLIANOU [0]
CYR195 M.STYLIANOU [8]
CYR195 M.STYLIANOU [8]
MNE278 V.POPOVIC [3]
GRE749 I.PAPADOPOULOS [8]
GRE749 I.PAPADOPOULOS [4]
GRE749 I.PAPADOPOULOS [3]
GRE469 A.LITOS [2]
GRE469 A.LITOS [3]
CRO391 D.SARAC [1]

AUT252 A.GRATZER [1]
AUT252 A.GRATZER [4]
AUT252 A.GRATZER
GRE749 I.PAPADOPOULOS [8]
GRE749 I.PAPADOPOULOS [3]

AUT252 A.GRATZER [4]
AUT252 A.GRATZER
GRE749 I.PAPADOPOULOS [3]

Pool 1

TATAMI

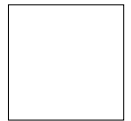

TATAMI

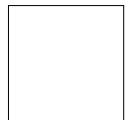

Pool 2

Cadet Kumite Male -70 kg



14th Balkan Cadet & Junior 3th U21 18th Children

SERBIA - Kragujevac

29/3/2013 - 31/3/2013

Cadet Kumite Male -70 kg

Repechage Pool 1

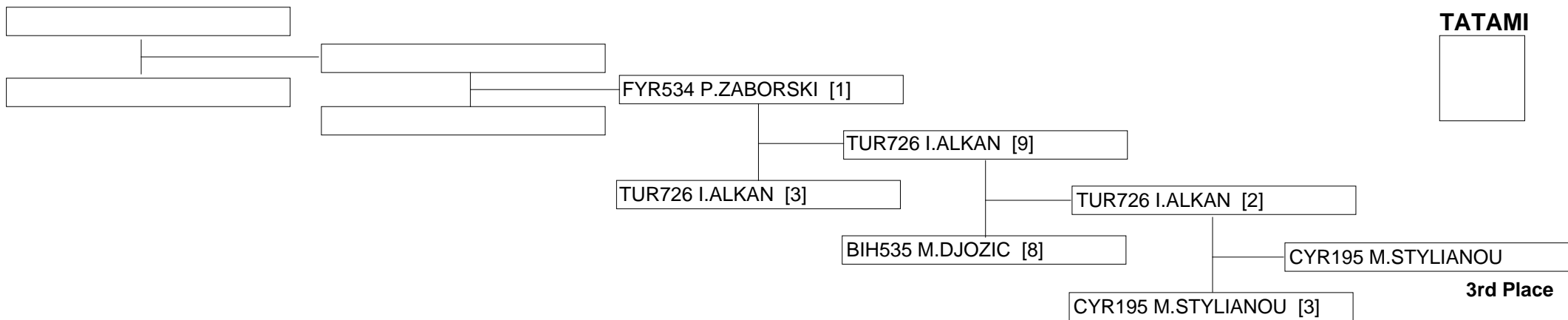

Repechage Pool 2

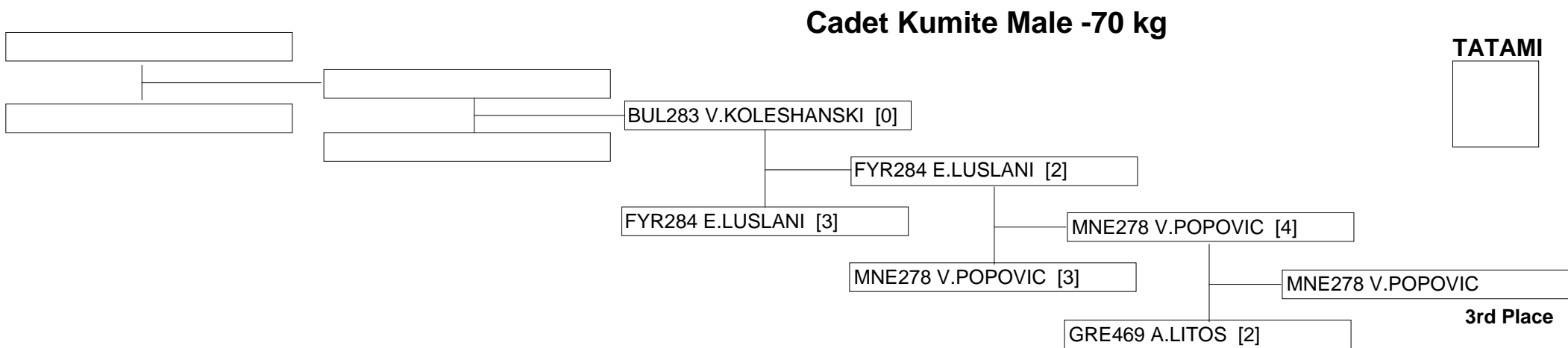



14th Balkan Cadet & Junior 3th U21 18th Children

SERBIA - Kragujevac

29/3/2013 - 31/3/2013

Cadet Kumite Female 54+ kg

Entries: 20

HUN282 T.PAL [1]
CRO354 L.REHAK [0]
BIH505 Z.PEKEZ []
<BYE>
TUR742 Z.COSKUN []
<BYE>
GRE559 M.KONTOGIANNI []
<BYE>
BIH542 S.LJUCA [0]
GRE505 I.MOUSOULI [6]
SRB276 T.ZUNIC []
<BYE>
FYR506 M.KOSTOVA []
<BYE>
MNE268 M.PAVLOVIC []
<BYE>
HUN239 D.CZAGANY [3]
CRO396 E.ZRINSCAK [0]
FYR365 R.NIKOLOVA []
<BYE>
GRE401 M.MASTROGIANNI []
<BYE>
SRB505 M.RADICEVIC []
<BYE>
AUT257 J.WAEGER [3]
BIH293 S.MUJIC [2]
CRO379 M.BARAC []
<BYE>
SRB324 A.VASOVIC []
<BYE>
CYR217 D.HOUVARTA []
<BYE>

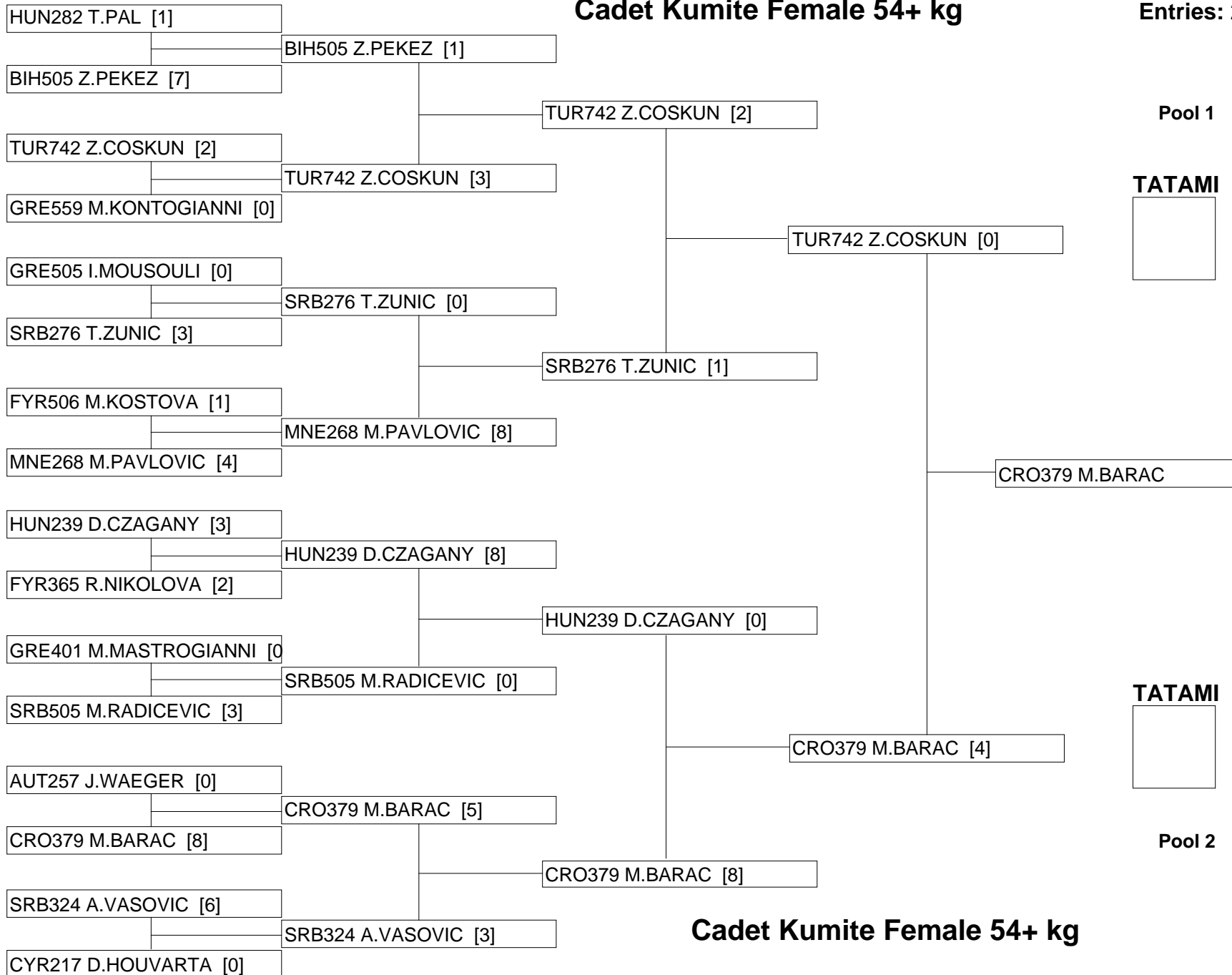



14th Balkan Cadet & Junior 3th U21 18th Children

SERBIA - Kragujevac

29/3/2013 - 31/3/2013

Cadet Kumite Female 54+ kg

Repechage Pool 1

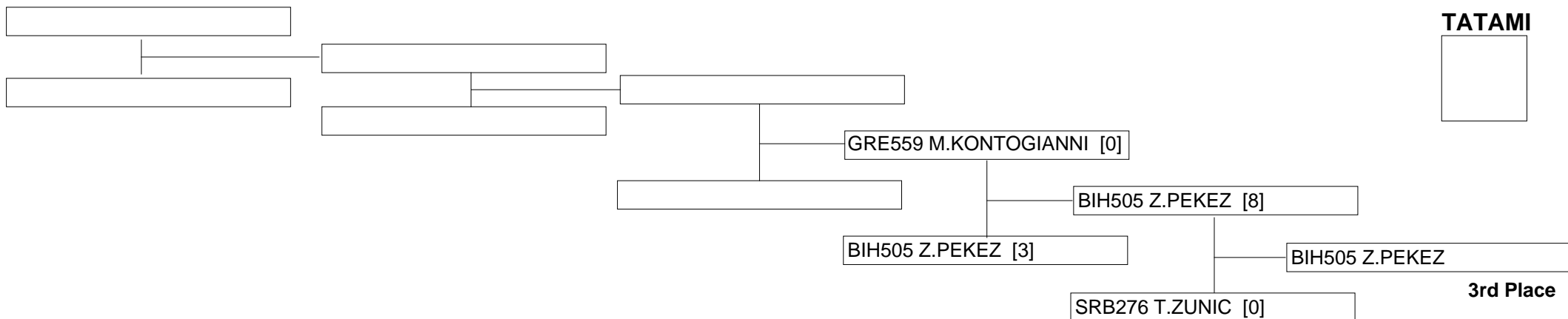

Repechage Pool 2

Cadet Kumite Female 54+ kg

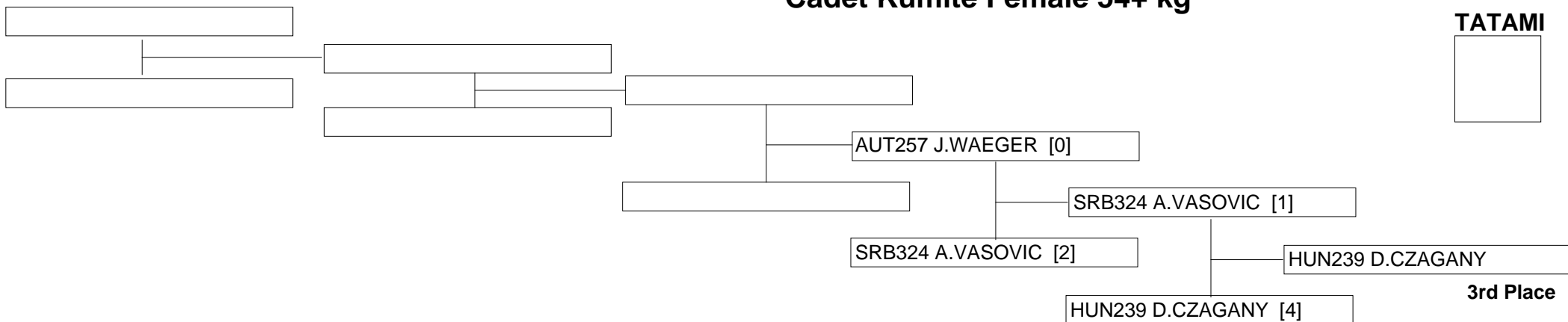



14th Balkan Cadet & Junior 3th U21 18th Children

SERBIA - Kragujevac

29/3/2013 - 31/3/2013

Cadet Kumite Female -47 kg

Entries: 16

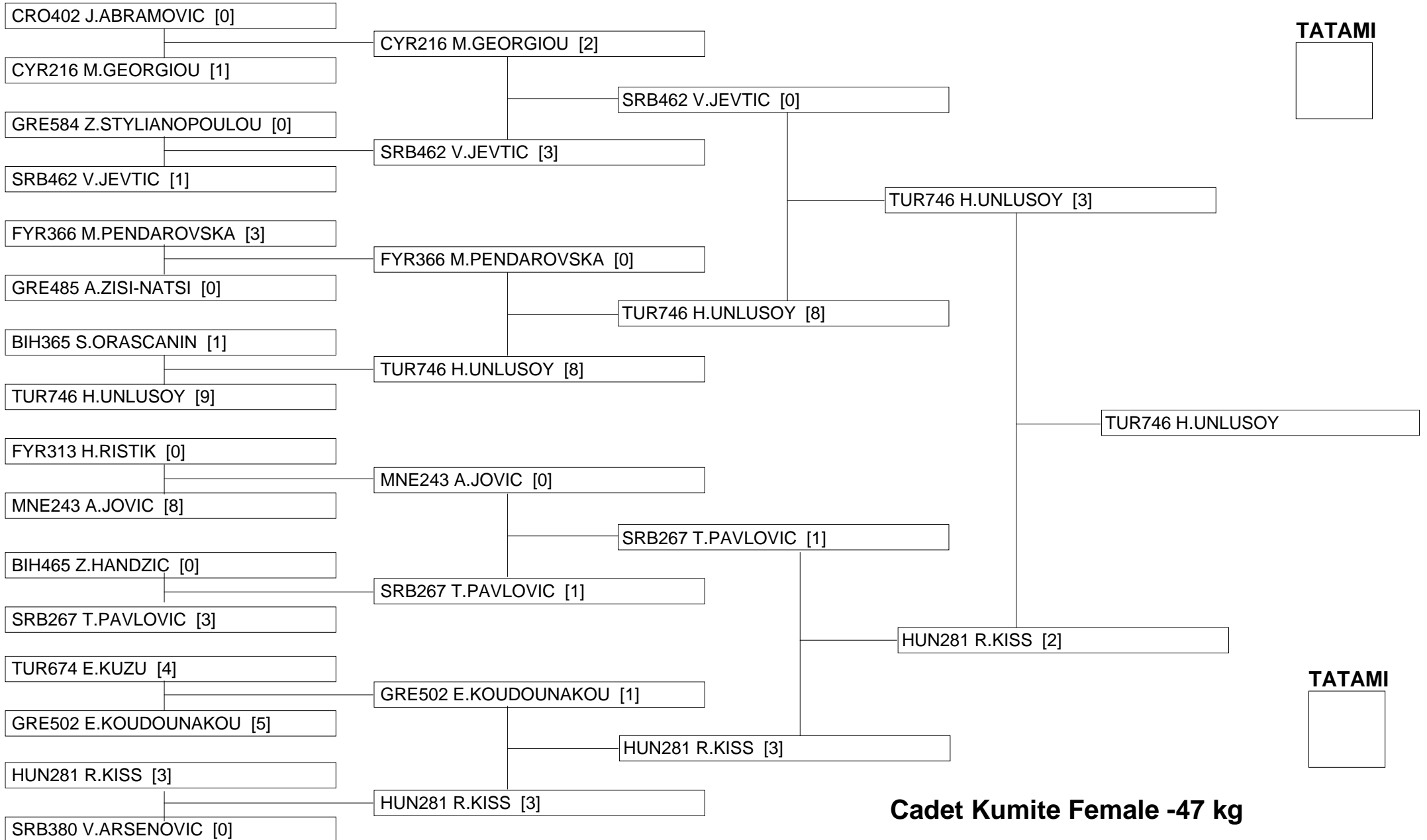



14th Balkan Cadet & Junior 3th U21 18th Children

SERBIA - Kragujevac

29/3/2013 - 31/3/2013

Cadet Kumite Female -47 kg

Repechage Pool 1

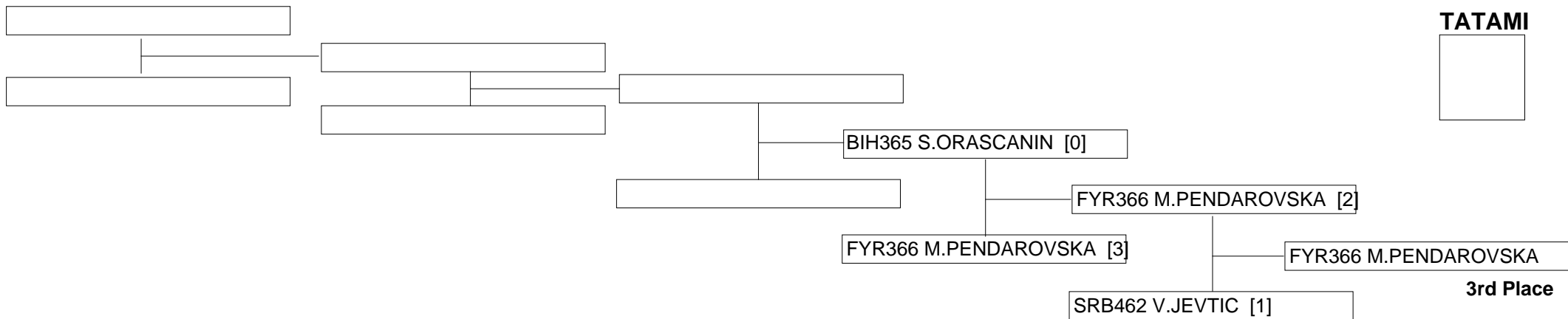

Repechage Pool 2

Cadet Kumite Female -47 kg

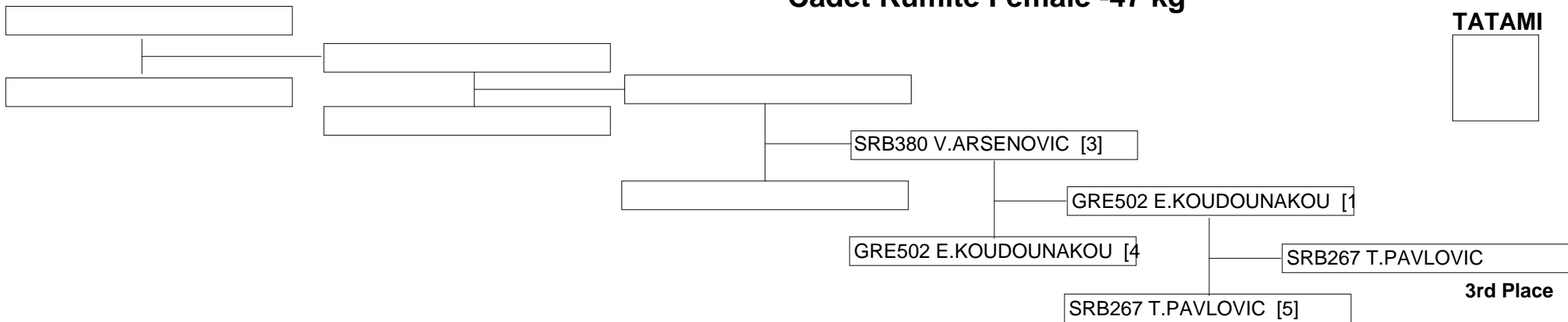



14th Balkan Cadet & Junior 3th U21 18th Children

SERBIA - Kragujevac

29/3/2013 - 31/3/2013

Cadet Kumite Female -54 kg

Entries: 18

SRB516 J.SINDJELIC [0]
BIH285 D.TADIC [3]
GRE382 A.ROUCHOTA []
<BYE>
TUR651 K.DEMIRTURK []
<BYE>
CRO393 A.TOMIC []
<BYE>
GRE345 D.KALAMARI []
<BYE>
SRB479 S.LAZIC []
<BYE>
FYR369 A.MOJSOVSKA []
<BYE>
MNE362 K.SUSKAVCEVIC []
<BYE>
SRB404 T.ZIVIC [0]
BIH307 A.BASIC [8]
FYR329 M.DIMOSKA []
<BYE>
HUN241 A.BOUSSEBAA []
<BYE>
MNE203 N.KILIBARDA []
<BYE>
BIH488 V.LIVOREKA []
<BYE>
TUR810 B.OZYAZMACI []
<BYE>
GRE735 D.LIAKOU []
<BYE>
FYR328 M.VASILEVA []
<BYE>





14th Balkan Cadet & Junior 3th U21 18th Children

SERBIA - Kragujevac

29/3/2013 - 31/3/2013

Cadet Kumite Female -54 kg

Repechage Pool 1

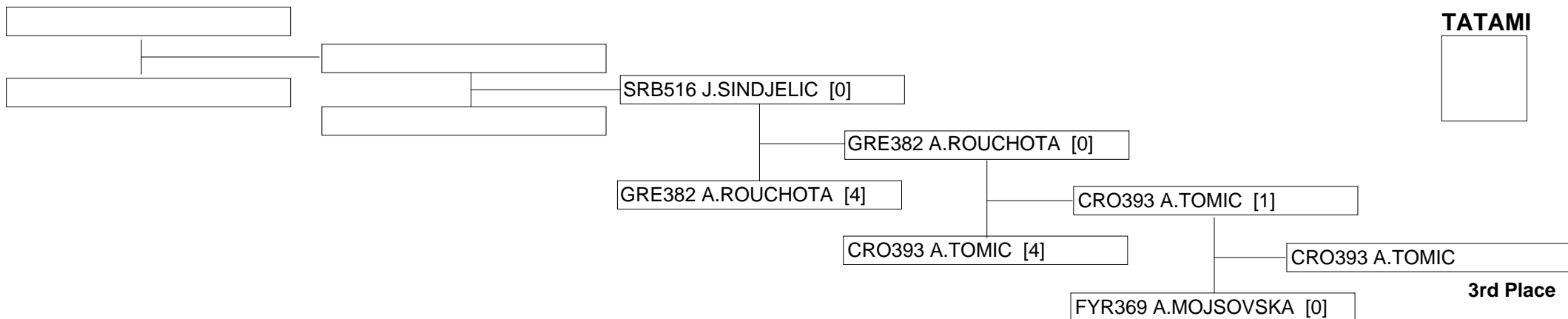

Repechage Pool 2

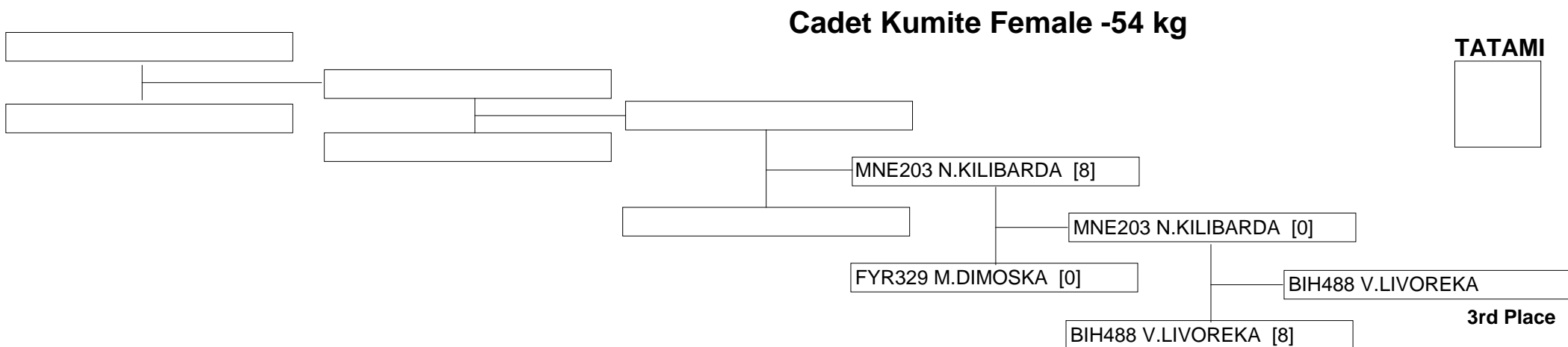



14th Balkan Cadet & Junior 3th U21 18th Children

SERBIA - Kragujevac

29/3/2013 - 31/3/2013

Junior Kumite Male 76+ kg

Entries: 21

FYR335 E.RISTEVSKI [8]
TUR525 E.ASKER [0]
SRB473 E.KOVACEVIC []
<BYE>
BIH263 N.VARUPA [7]
GRE734 S.LAZOS [0]
MNE262 M.PETRIC []
<BYE>
BIH269 A.CONGO []
GRE723 G.KATSIARAS []
FYR539 M.STOJMANOVIKJ []
<BYE>
MNE206 N.DABANOVIC []
<BYE>
TUR505 A.YAMANOGLU []
<BYE>
GRE523 N.VAVOULIDIS []
MNE401 V.NIKOLIC []
SRB427 M.BOJANIC []
<BYE>
BIH478 S.KANLIC []
<BYE>
FYR389 S.KJOSOVIKJ []
<BYE>
SRB308 N.PLANIC []
SLO257 P.SUMANDL []
HUN242 C.FOLDESI []
<BYE>
TUR791 M.GARIP []
<BYE>
CRO380 F.BARAC []
<BYE>





14th Balkan Cadet & Junior 3th U21 18th Children

SERBIA - Kragujevac

29/3/2013 - 31/3/2013

Junior Kumite Male 76+ kg

Repechage Pool 1

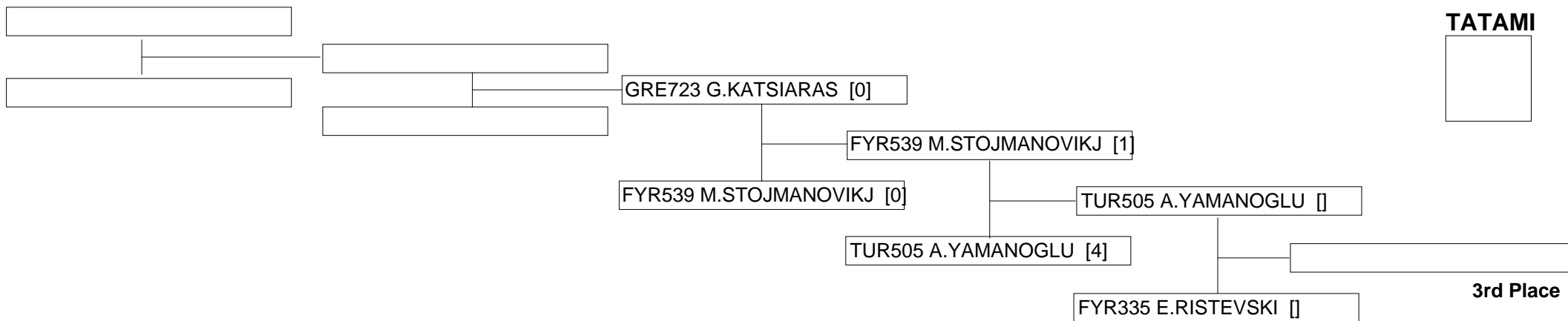

Repechage Pool 2

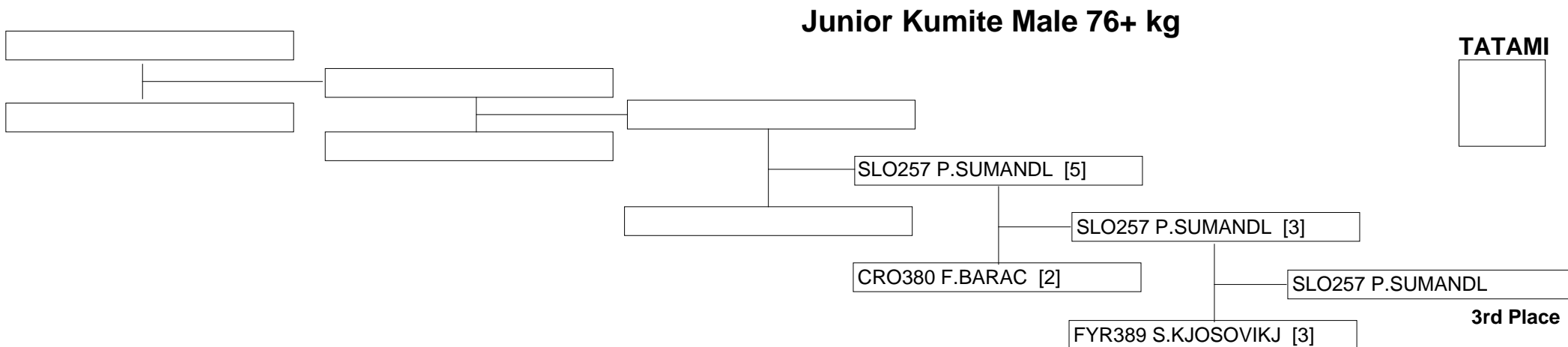



14th Balkan Cadet & Junior 3th U21 18th Children

SERBIA - Kragujevac

29/3/2013 - 31/3/2013

Junior Kumite Male -55 kg

Entries: 20

SRB457 D.HITREC [3]
ALB176 R.MRACA [0]
GRE641 G.PANOS []
<BYE>
MNE379 M.LJUSI []
<BYE>
TUR752 E.CINAR []
<BYE>
SRB307 D.AHMETOVIC [0]
HUN251 L.HIMPLI [5]
BIH450 G.HRKAC []
<BYE>
FYR383 M.GJURCHINOVSKI []
<BYE>
TUR818 O.TANDOGAN []
<BYE>
BIH326 I.KRIZANAC [1]
FYR469 A.BOSKOSKI [0]
TUR568 T.MACAR []
<BYE>
GRE358 I.CHARALAMPIDIS []
<BYE>
CYR192 I.KYROY []
<BYE>
MNE233 A.MARKASHEVIQ [0]
GRE429 M.RELIAS [4]
SRB255 N.ISAILOVIC []
<BYE>
CRO343 B.BERAK []
<BYE>
HUN257 T.DERZSI []
<BYE>



Pool 1

TATAMI

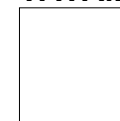

TATAMI

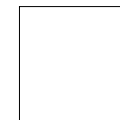

Pool 2

Junior Kumite Male -55 kg



14th Balkan Cadet & Junior 3th U21 18th Children

SERBIA - Kragujevac

29/3/2013 - 31/3/2013

Junior Kumite Male -55 kg

Repechage Pool 1

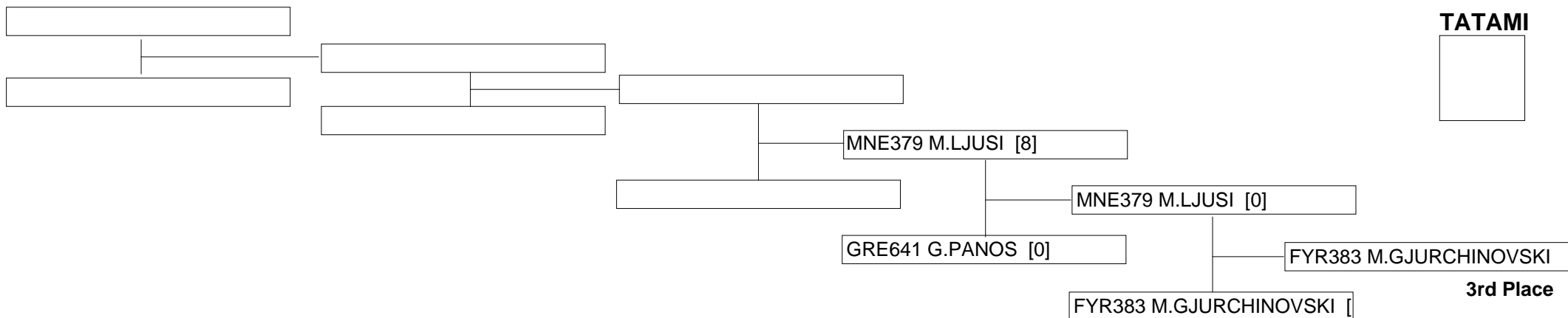

Repechage Pool 2

Junior Kumite Male -55 kg

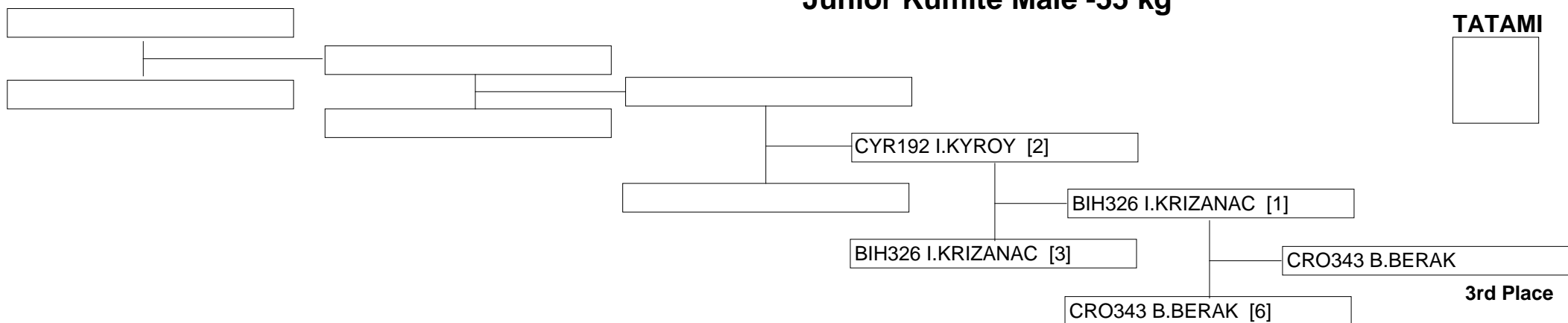



14th Balkan Cadet & Junior 3th U21 18th Children

SERBIA - Kragujevac

29/3/2013 - 31/3/2013

Junior Kumite Male -61 kg

Entries: 26

CYR209 A.POLIDOROU [0]
BIH314 E.GALIC [7]
GRE747 P.PANTAZIS [3]
MNE373 M.GALUSIC [0]
TUR562 A.CELEN [8]
ROM267 B.GOGOLOSI [0]
FYR299 M.STOJMENOV []
<BYE>
HUN256 P.VIRGA [8]
TUR506 S.DEMIR [0]
SRB298 M.DZAKOVIC []
<BYE>
BUL260 A.DIMITROV [6]
CRO373 R.SGARDELLI [3]
GRE362 A.POLICHRONOS []
<BYE>
CRO322 D.POVRZENIC [4]
SRB302 M.MARTINOVIC [0]
BUL344 V.ANGELOV [0]
BIH501 A.NIKOLIC [3]
MNE204 A.HODZIC [5]
CYR194 C.IOANNIDES [0]
TUR749 F.MERCAN []
<BYE>
CRO406 D.BORSOS [0]
FYR302 N.DIMITRIEVIC [8]
GRE506 D.MITAKOS []
<BYE>
AUT234 L.RETTENBACHER [0]
SRB419 A.LEKIC [3]
HUN313 B.KRONSTEIN []
<BYE>

BIH314 E.GALIC [8]
BIH314 E.GALIC [5]
GRE747 P.PANTAZIS [0]
BIH314 E.GALIC [8]
TUR562 A.CELEN [1]
FYR299 M.STOJMENOV [0]
FYR299 M.STOJMENOV [2]
HUN256 P.VIRGA [0]
SRB298 M.DZAKOVIC [8]
SRB298 M.DZAKOVIC [3]
SRB298 M.DZAKOVIC [0]
BUL260 A.DIMITROV [2]
BUL260 A.DIMITROV [0]
GRE362 A.POLICHRONOS [0]
CRO322 D.POVRZENIC [3]
CRO322 D.POVRZENIC [8]
BIH501 A.NIKOLIC [0]
CRO322 D.POVRZENIC [0]
MNE204 A.HODZIC [2]
MNE204 A.HODZIC [0]
TUR749 F.MERCAN [0]
FYR302 N.DIMITRIEVIC [2]
FYR302 N.DIMITRIEVIC [2]
GRE506 D.MITAKOS [0]
SRB419 A.LEKIC [2]
SRB419 A.LEKIC [3]
HUN313 B.KRONSTEIN [1]



Pool 1

TATAMI

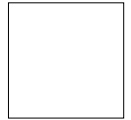

TATAMI

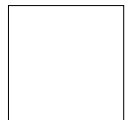

Pool 2

Junior Kumite Male -61 kg



14th Balkan Cadet & Junior 3th U21 18th Children

SERBIA - Kragujevac

29/3/2013 - 31/3/2013

Junior Kumite Male -61 kg

Repechage Pool 1

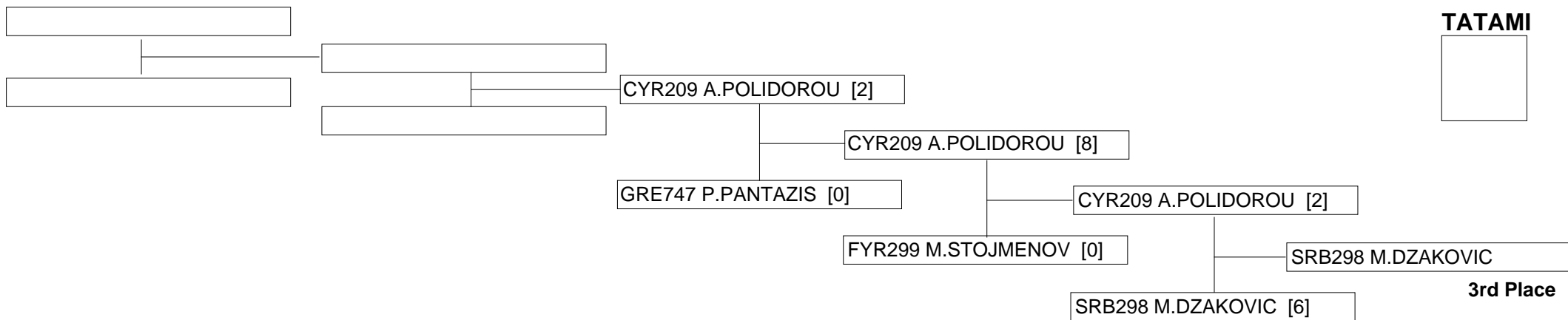

Repechage Pool 2

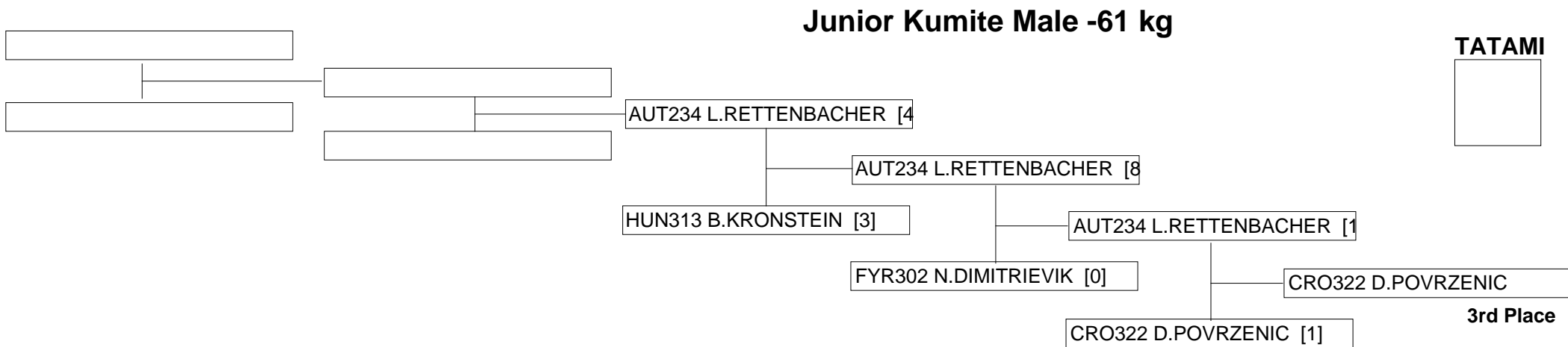



14th Balkan Cadet & Junior 3th U21 18th Children

SERBIA - Kragujevac

29/3/2013 - 31/3/2013

Junior Kumite Male -68 kg

Entries: 31

ALB180 D.SHABAJ [0]
BUL261 M.YORDANOV [3]
GRE307 D.XENOS [8]
CYR212 C.DIAMANTIDES [0]
FYR528 I.TANEVSKI [4]
HUN288 K.HORVATH [1]
TUR541 D.ATES [8]
MNE266 M.GOLUBOVIC [0]
MNE384 I.ZEKOVIC [0]
SRB278 B.DUKANOVIC [5]
CRO323 M.SITUM [1]
GRE280 D.PETSALAS [3]
BIH447 A.BRICA [4]
AUT247 R.RETTENBACHER []
HUN203 N.SZILVA [1]
TUR717 M.GONUL [3]
GRE346 I.MOUTAFTSIS [7]
FYR472 D.IDRIZI [1]
SLO255 T.OTRIN [8]
ALB168 M.DOMI [0]
TUR378 M.KAYA [5]
BIH271 A.SALIHVIC [0]
SRB272 A.TINTOR [8]
BUL350 S.BODUROV [1]
SRB425 S.NESKOVIC [8]
MNE370 A.PALAMAR [0]
BUL256 M.RANOV [0]
HUN230 A.RUSOCZKI [1]
CRO310 P.LAMESIC [0]
FYR342 A.ISMAIL [2]
BIH332 M.CATOVIC []
<BYE>

BUL261 M.YORDANOV [0]
GRE307 D.XENOS [7]
GRE307 D.XENOS [9]
FYR528 I.TANEVSKI [0]
TUR541 D.ATES [1]
TUR541 D.ATES [7]
SRB278 B.DUKANOVIC [0]
GRE280 D.PETSALAS [0]
GRE280 D.PETSALAS [3]
BIH447 A.BRICA [1]
BIH447 A.BRICA [1]
BIH447 A.BRICA [3]
TUR717 M.GONUL [0]
GRE346 I.MOUTAFTSIS [6]
GRE346 I.MOUTAFTSIS [1]
SLO255 T.OTRIN [0]
TUR378 M.KAYA [2]
TUR378 M.KAYA [5]
SRB272 A.TINTOR [0]
SRB425 S.NESKOVIC [1]
HUN230 A.RUSOCZKI [2]
HUN230 A.RUSOCZKI [2]
FYR342 A.ISMAIL [8]
FYR342 A.ISMAIL [5]
BIH332 M.CATOVIC [0]

GRE307 D.XENOS [7]
GRE307 D.XENOS [3]
TUR541 D.ATES [1]
GRE307 D.XENOS [8]
BIH447 A.BRICA [1]
BIH447 A.BRICA [3]
GRE346 I.MOUTAFTSIS [1]
TUR378 M.KAYA [1]
TUR378 M.KAYA [5]
FYR342 A.ISMAIL [0]
FYR342 A.ISMAIL [5]

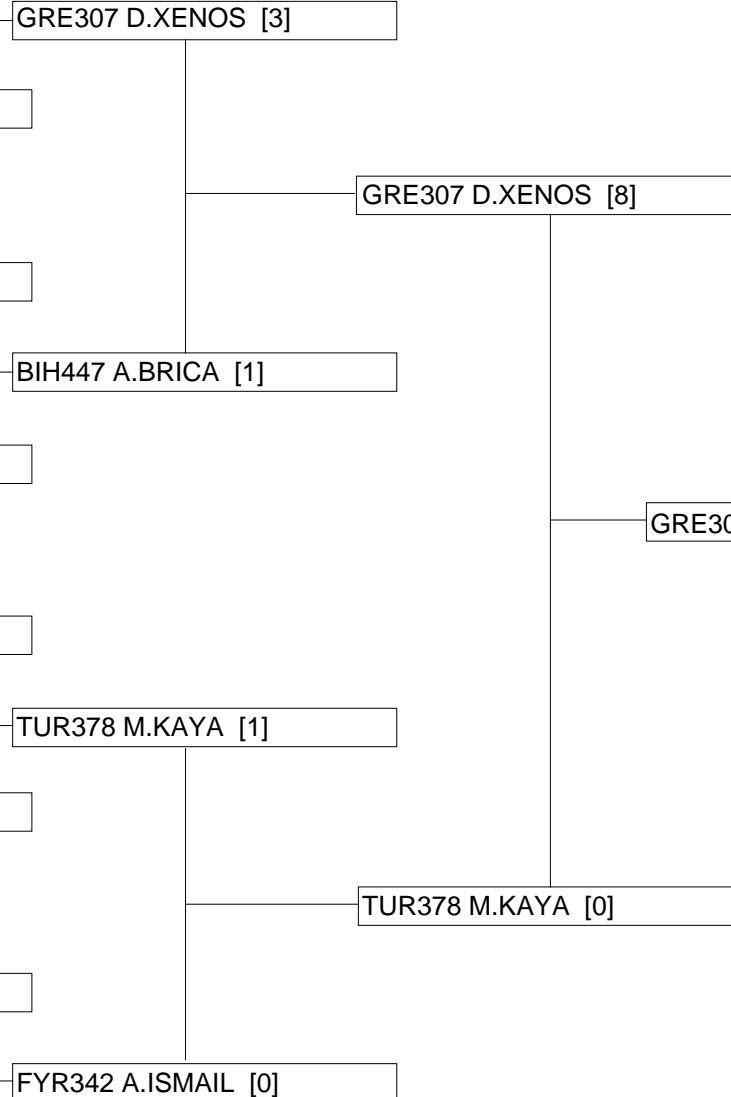

Pool 1

TATAMI

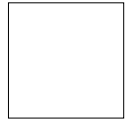

TATAMI

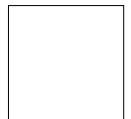

Pool 2

Junior Kumite Male -68 kg



14th Balkan Cadet & Junior 3th U21 18th Children

SERBIA - Kragujevac

29/3/2013 - 31/3/2013

Junior Kumite Male -68 kg

Repechage Pool 1

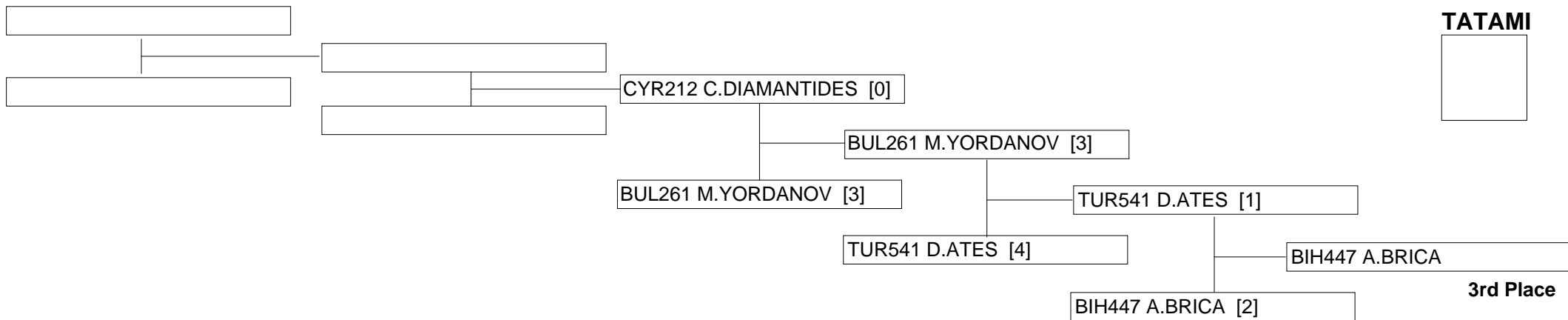

Repechage Pool 2

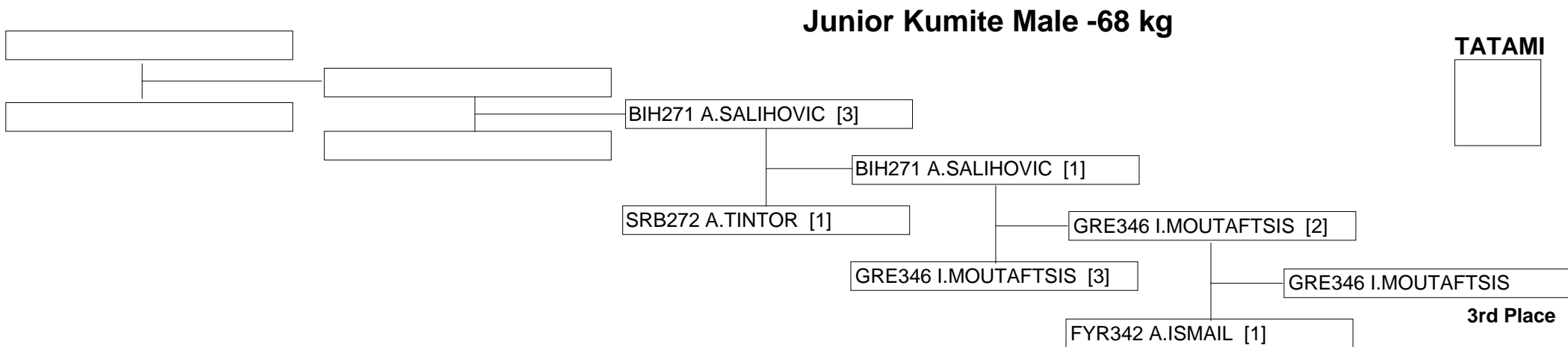



14th Balkan Cadet & Junior 3th U21 18th Children

SERBIA - Kragujevac

29/3/2013 - 31/3/2013

Junior Kumite Male -76 kg

Entries: 30

MNE254 M.MATOVIC [6]
FYR477 M.KAMILI [1]
GRE272 T.KALOGIANNIS [0]
SRB273 B.MISOVIC [4]
ROM269 C.MIHALACHE [9]
BIH481 A.KISO [0]
HUN215 D.GYORGY [1]
TUR758 I.PEK [0]
BUL339 R.VACHEV [0]
BIH446 A.ALIVUK [8]
MNE246 N.MALOVIC [0]
HUN258 G.HARSPATAKI [6]
SLO256 K.ZUBER [6]
SRB527 S.TODOROVIC [3]
CYR210 G.PAPAGEORGIU []
<BYE>
MNE263 V.KOPITOVIC [1]
HUN308 D.HONING [0]
CYR287 T.LOIZIDES [0]
ROM266 N.DANCILA [1]
GRE423 N.DRIVAS [1]
FYR270 V.KRSTEVSKI [0]
CRO374 V.LONCAR [1]
TUR804 E.KOSIFOGLU [0]
SLO271 M.BOLTAR [0]
SRB534 F.VUKOVIC [4]
BIH453 N.BAJROVC [3]
TUR813 A.SAHIN [2]
BUL355 P.FERDINANDOV [1]
GRE693 N.BASOUKOS [2]
FYR494 O.BILJALI []
<BYE>





14th Balkan Cadet & Junior 3th U21 18th Children

SERBIA - Kragujevac

29/3/2013 - 31/3/2013

Junior Kumite Male -76 kg

Repechage Pool 1

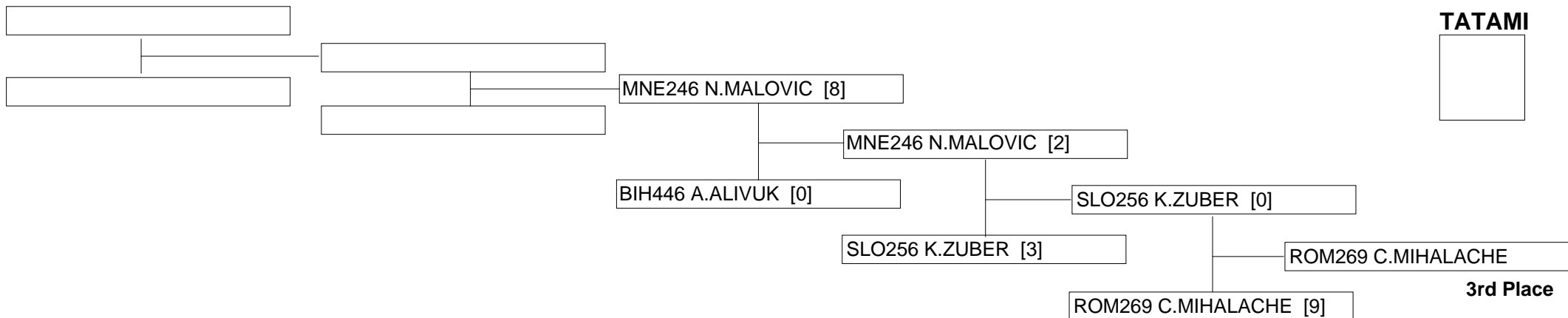

Repechage Pool 2

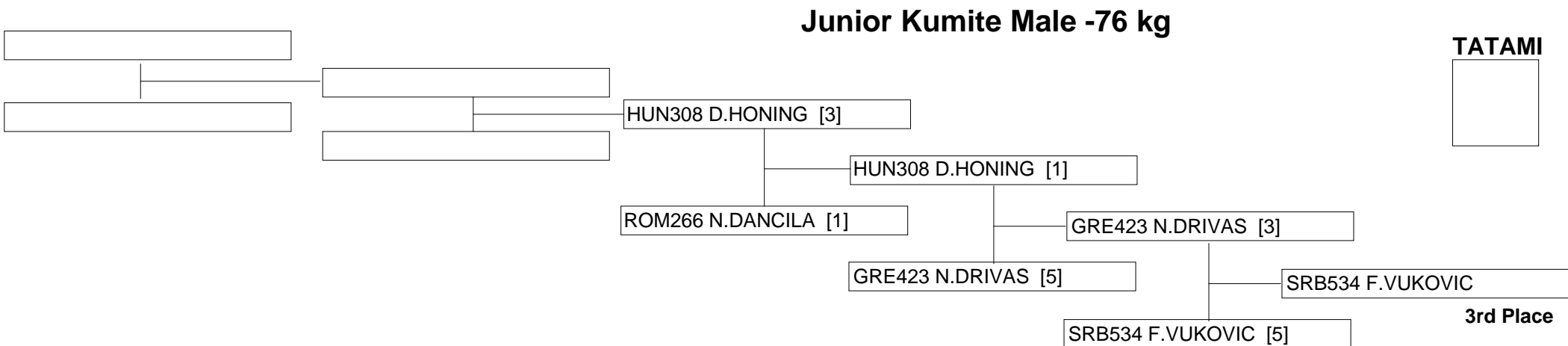



14th Balkan Cadet & Junior 3th U21 18th Children

SERBIA - Kragujevac

29/3/2013 - 31/3/2013

Junior Kumite Female 59+ kg

Entries: 18

FYR272 K.KRSTEVSKA [1]
TUR521 H.PUNAR [5]
CYR207 S.ANTONIOU []
<BYE>
GRE419 A.DELLI []
<BYE>
CRO381 S.BUZALJKO []
<BYE>
FYR382 D.TODOROVA []
<BYE>
BIH536 N.DZAFIC []
<BYE>
HUN231 E.SZABO []
<BYE>
SRB438 M.STRAINOVIC []
<BYE>
FYR315 I.ATANASOVA [0]
SRB422 N.NIKLIC [3]
GRE737 A.LOYKI []
<BYE>
BIH457 E.BRKIC []
<BYE>
BUL255 M.PLACHKOVA []
<BYE>
MNE391 J.DJURKOVIC []
<BYE>
SRB297 M.GARIBOVIC []
<BYE>
GRE761 N.THEODOSIADI []
<BYE>
BIH320 I.CAVAR []
<BYE>





14th Balkan Cadet & Junior 3th U21 18th Children

SERBIA - Kragujevac

29/3/2013 - 31/3/2013

Junior Kumite Female 59+ kg

Repechage Pool 1

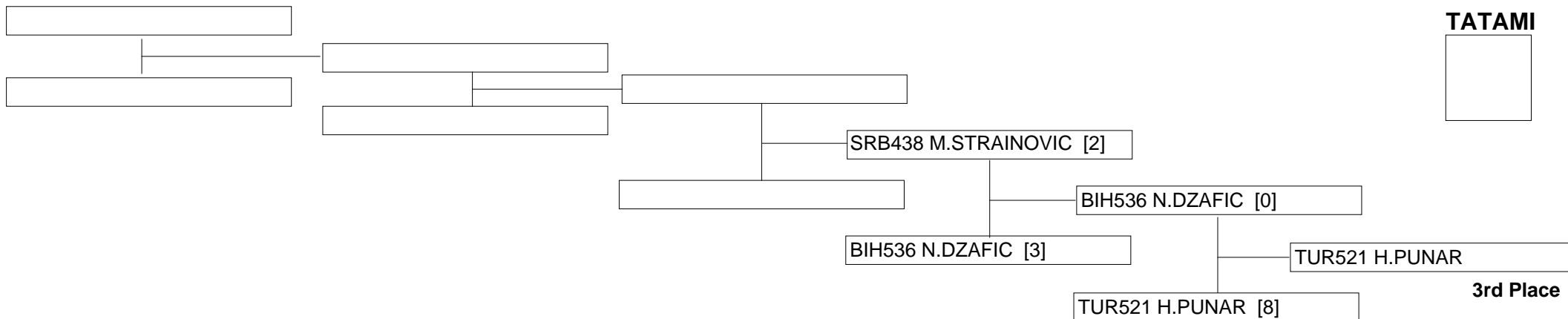

Repechage Pool 2

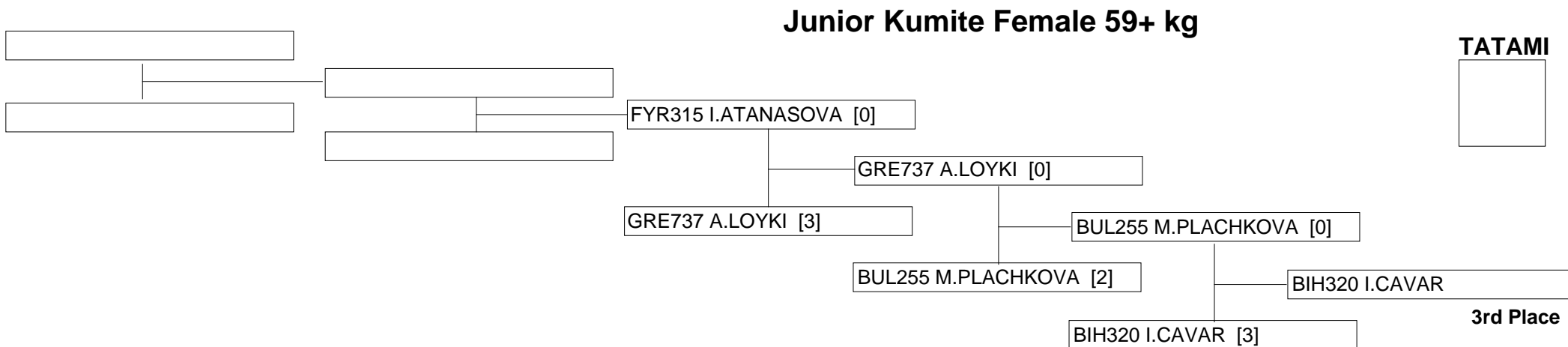



14th Balkan Cadet & Junior 3th U21 18th Children

SERBIA - Kragujevac

29/3/2013 - 31/3/2013

Junior Kumite Female -48 kg

Entries: 16

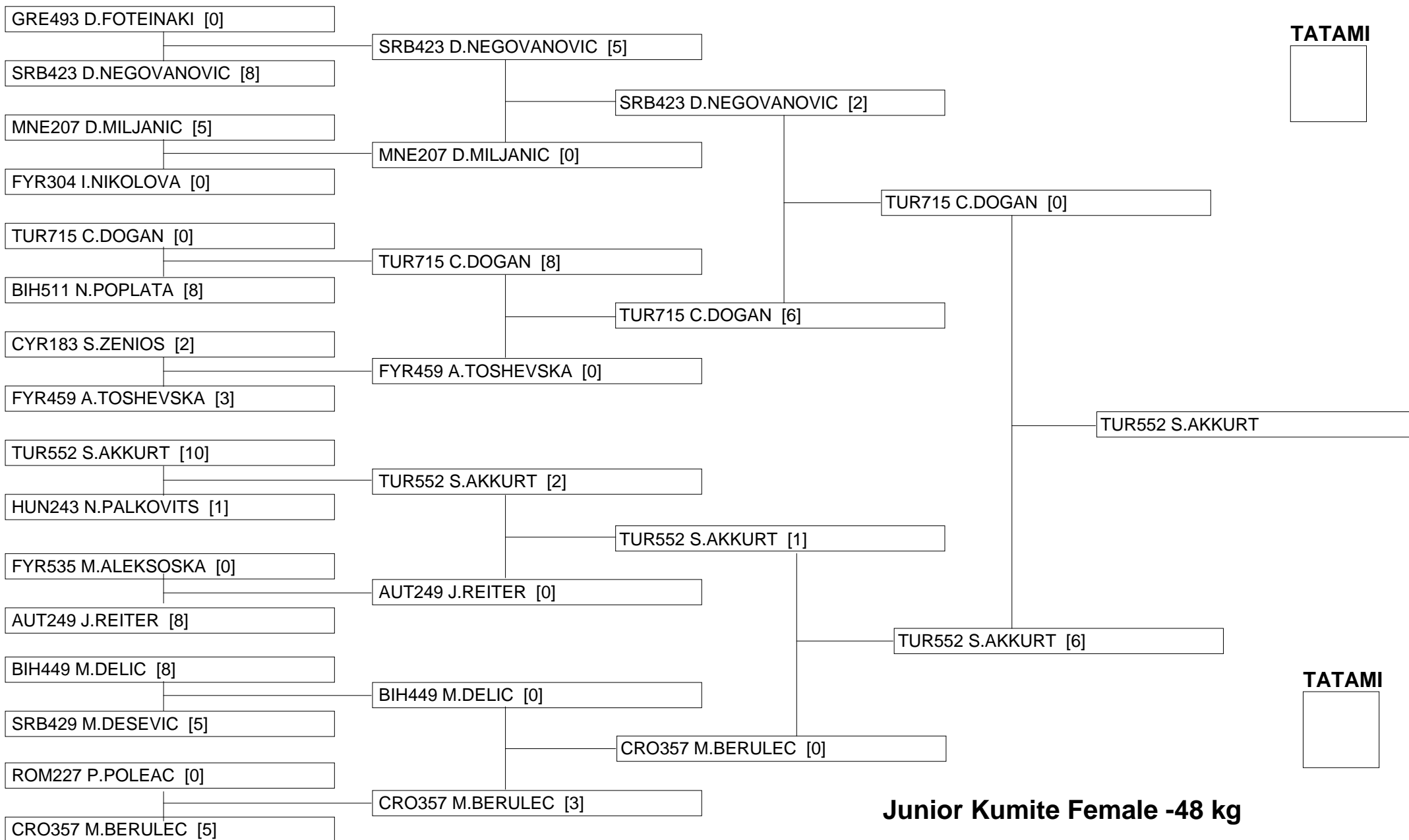



14th Balkan Cadet & Junior 3th U21 18th Children

SERBIA - Kragujevac

29/3/2013 - 31/3/2013

Junior Kumite Female -48 kg

Repechage Pool 1

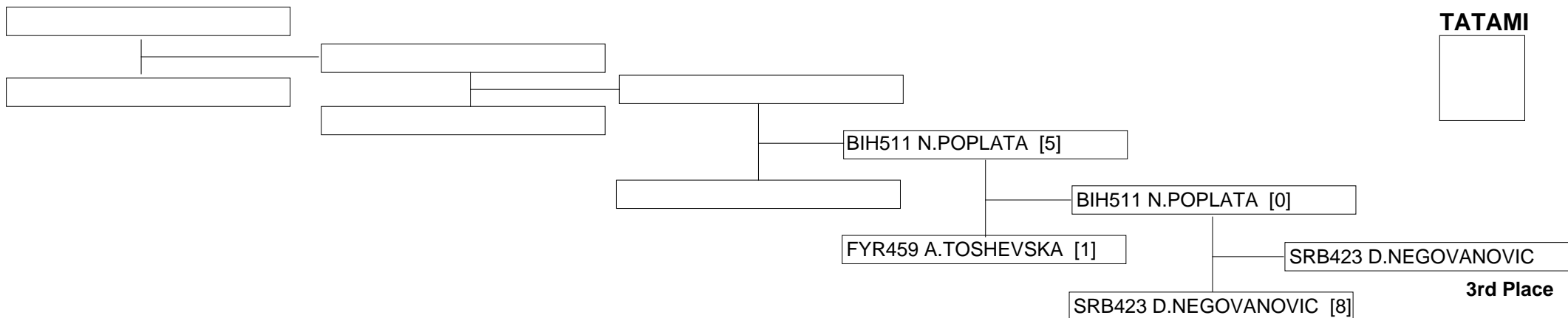

Repechage Pool 2

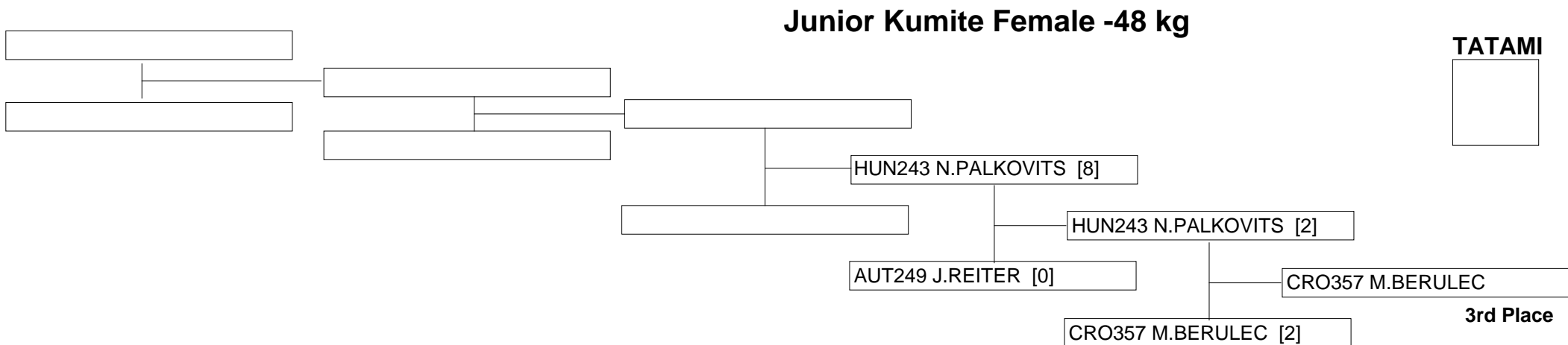



14th Balkan Cadet & Junior 3th U21 18th Children

SERBIA - Kragujevac

29/3/2013 - 31/3/2013

Junior Kumite Female -53 kg

Entries: 22

HUN219 B.BAKO [1]
MNE208 M.MICUNOVIC [11]
BUL224 J.SOTIROVA []
<BYE>
TUR800 Z.KANDEMIR [1]
SRB339 S.DJORDJEVIC [0]
GRE692 M.BALAOURA []
<BYE>
GRE707 E.FILI [0]
TUR497 T.BUYUKTAZIM [7]
BUL247 M.ILIEVA []
<BYE>
BIH499 N.MUSIC []
<BYE>
FYR467 S.ANGIEVA []
<BYE>
FYR298 B.MLADENOSKA [0]
CRO361 N.DESA [5]
GRE302 M.ROUMELIOTI []
<BYE>
BUL238 S.VANGELOVA [2]
TUR718 S.GUNGEL [0]
BIH317 A.MEKIC []
<BYE>
FYR332 N.MATRAKOSKA [0]
HUN244 N.NOGRADI [8]
BIH333 E.GLJIVA []
<BYE>
SRB279 V.DUKIC []
<BYE>
SLO238 D.CATAKOVIC []
<BYE>

MNE208 M.MICUNOVIC [0]
BUL224 J.SOTIROVA [2]
BUL224 J.SOTIROVA [3]
TUR800 Z.KANDEMIR [0]
GRE692 M.BALAOURA [3]
GRE692 M.BALAOURA [2]
TUR497 T.BUYUKTAZIM [2]
BUL247 M.ILIEVA [4]
BUL247 M.ILIEVA [3]
BIH499 N.MUSIC [1]
BIH499 N.MUSIC [1]
FYR467 S.ANGIEVA [0]
CRO361 N.DESA [0]
GRE302 M.ROUMELIOTI [5]
GRE302 M.ROUMELIOTI [5]
BUL238 S.VANGELOVA [2]
BIH317 A.MEKIC [2]
BIH317 A.MEKIC [3]
HUN244 N.NOGRADI [5]
HUN244 N.NOGRADI [5]
BIH333 E.GLJIVA [0]
SRB279 V.DUKIC [1]
SLO238 D.CATAKOVIC [0]
SLO238 D.CATAKOVIC [5]

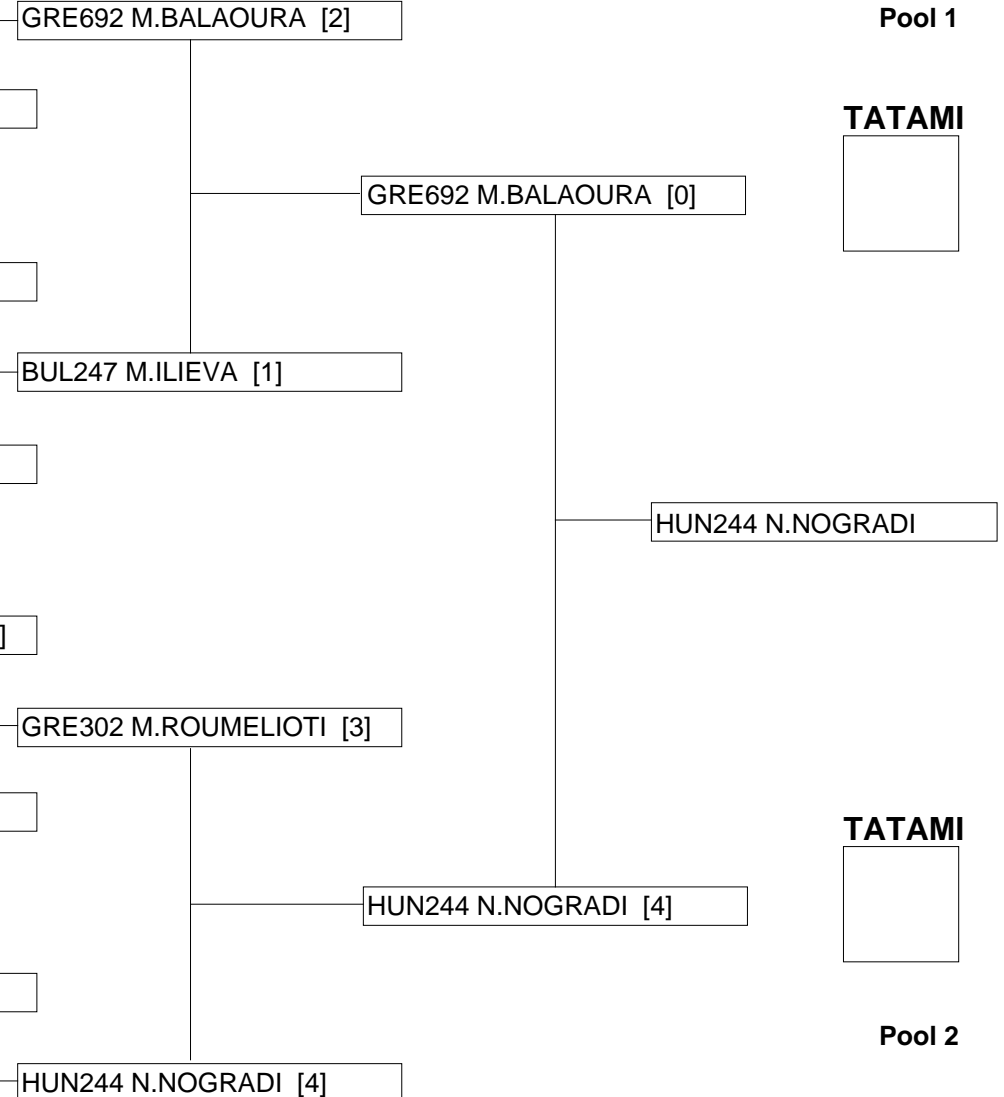

Pool 1

TATAMI

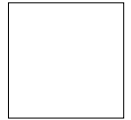

TATAMI

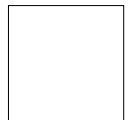

Pool 2

Junior Kumite Female -53 kg



14th Balkan Cadet & Junior 3th U21 18th Children

SERBIA - Kragujevac

29/3/2013 - 31/3/2013

Junior Kumite Female -53 kg

Repechage Pool 1

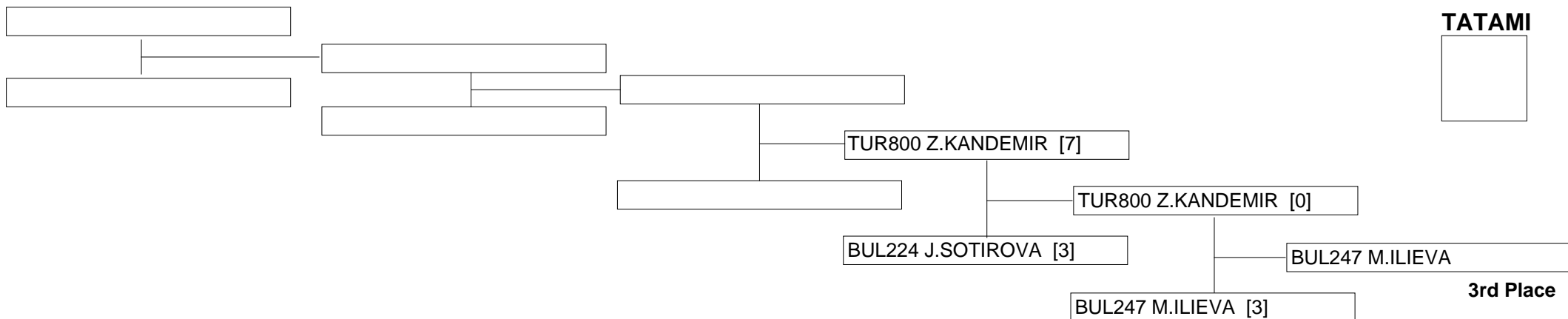

Repechage Pool 2

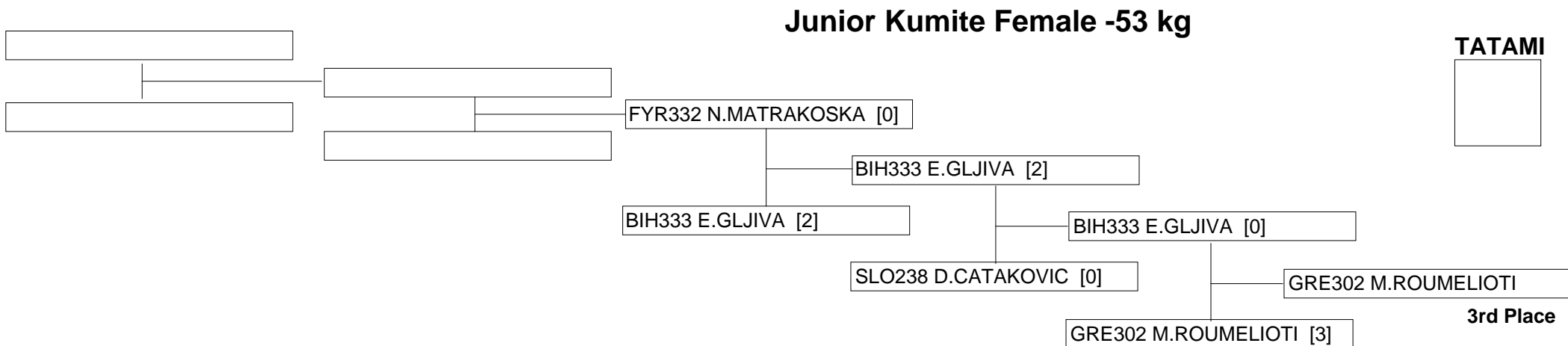



14th Balkan Cadet & Junior 3th U21 18th Children

SERBIA - Kragujevac

29/3/2013 - 31/3/2013

Junior Kumite Female -59 kg

Entries: 21

SRB440 J.VULINOVIC [1]
GRE688 D.STOLTIDOU [3]
SLO259 K.FLORJANCIC []
<BYE>
MNE405 A.RONCEVIC [0]
BIH305 Z.BEKTAS [8]
CRO385 K.KATAVIC []
<BYE>
TUR702 E.KAPAK [4]
BUL293 A.STUBLEVA [2]
BIH319 T.MARIC []
<BYE>
SRB274 J.PREKOVIC []
<BYE>
CYR219 A.IOANNOU []
<BYE>
MNE239 A.MIJATOVIC [5]
GRE674 N.VROUTSI [2]
BIH543 E.MAHMUTBEGOVIC [1]
<BYE>
CYR206 M.ADAMOU []
<BYE>
BUL380 S.YAKIMOVA []
<BYE>
SRB484 D.MAKSIC [2]
BUL254 E.RIZOVA [3]
FYR488 S.STOJKOSKA []
<BYE>
CRO341 A.STJEPANDIC []
<BYE>
TUR820 C.TEKE []
<BYE>

GRE688 D.STOLTIDOU [6]
GRE688 D.STOLTIDOU [0]
SLO259 K.FLORJANCIC [0]
BIH305 Z.BEKTAS [3]
BIH305 Z.BEKTAS [4]
CRO385 K.KATAVIC [0]
TUR702 E.KAPAK [0]
BIH319 T.MARIC [5]
BIH319 T.MARIC [2]
SRB274 J.PREKOVIC [8]
SRB274 J.PREKOVIC [0]
CYR219 A.IOANNOU [0]
MNE239 A.MIJATOVIC [7]
MNE239 A.MIJATOVIC [0]
BIH543 E.MAHMUTBEGOVIC [1]
CYR206 M.ADAMOU [7]
CYR206 M.ADAMOU [8]
BUL380 S.YAKIMOVA [1]
BUL254 E.RIZOVA [8]
BUL254 E.RIZOVA [0]
FYR488 S.STOJKOSKA [0]
CRO341 A.STJEPANDIC [4]
TUR820 C.TEKE [1]
TUR820 C.TEKE [7]

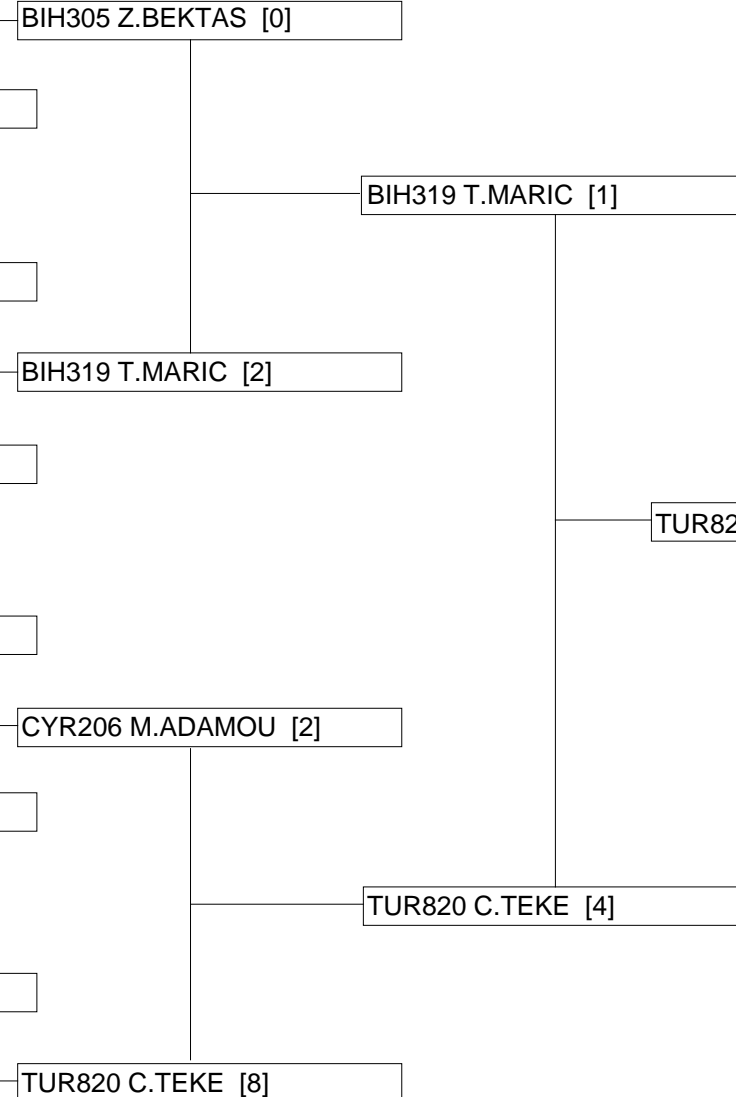

Pool 1

TATAMI

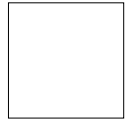

TATAMI

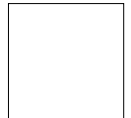

Pool 2

Junior Kumite Female -59 kg



14th Balkan Cadet & Junior 3th U21 18th Children

SERBIA - Kragujevac

29/3/2013 - 31/3/2013

Junior Kumite Female -59 kg

Repechage Pool 1

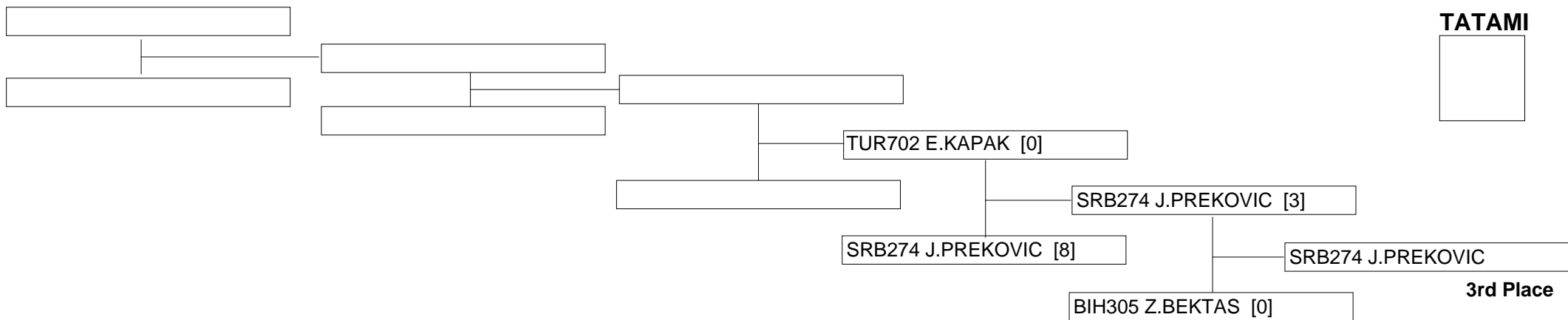

Repechage Pool 2

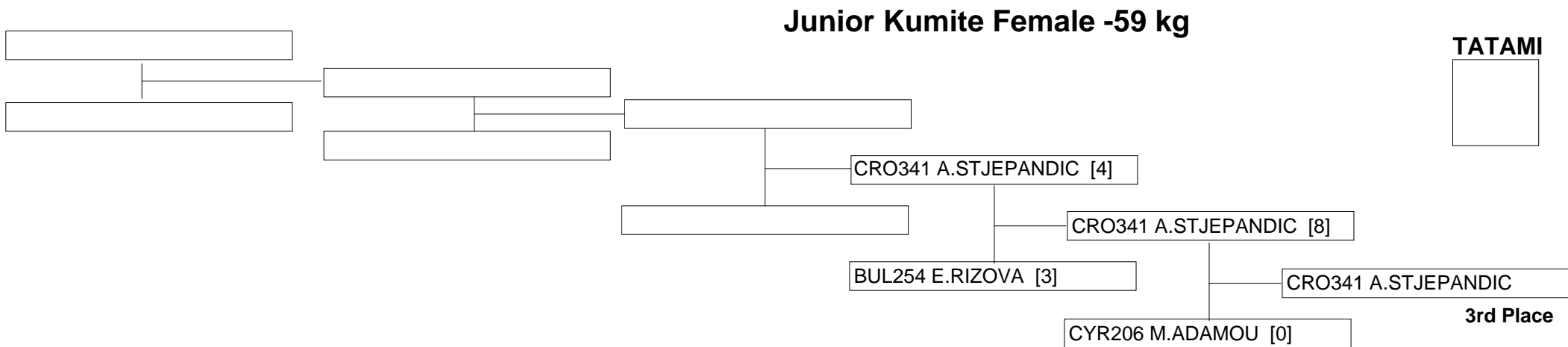



14th Balkan Cadet & Junior 3th U21 18th Children

SERBIA - Kragujevac

29/3/2013 - 31/3/2013

Cadet/Junior Team Kumite Male

Entries: 9

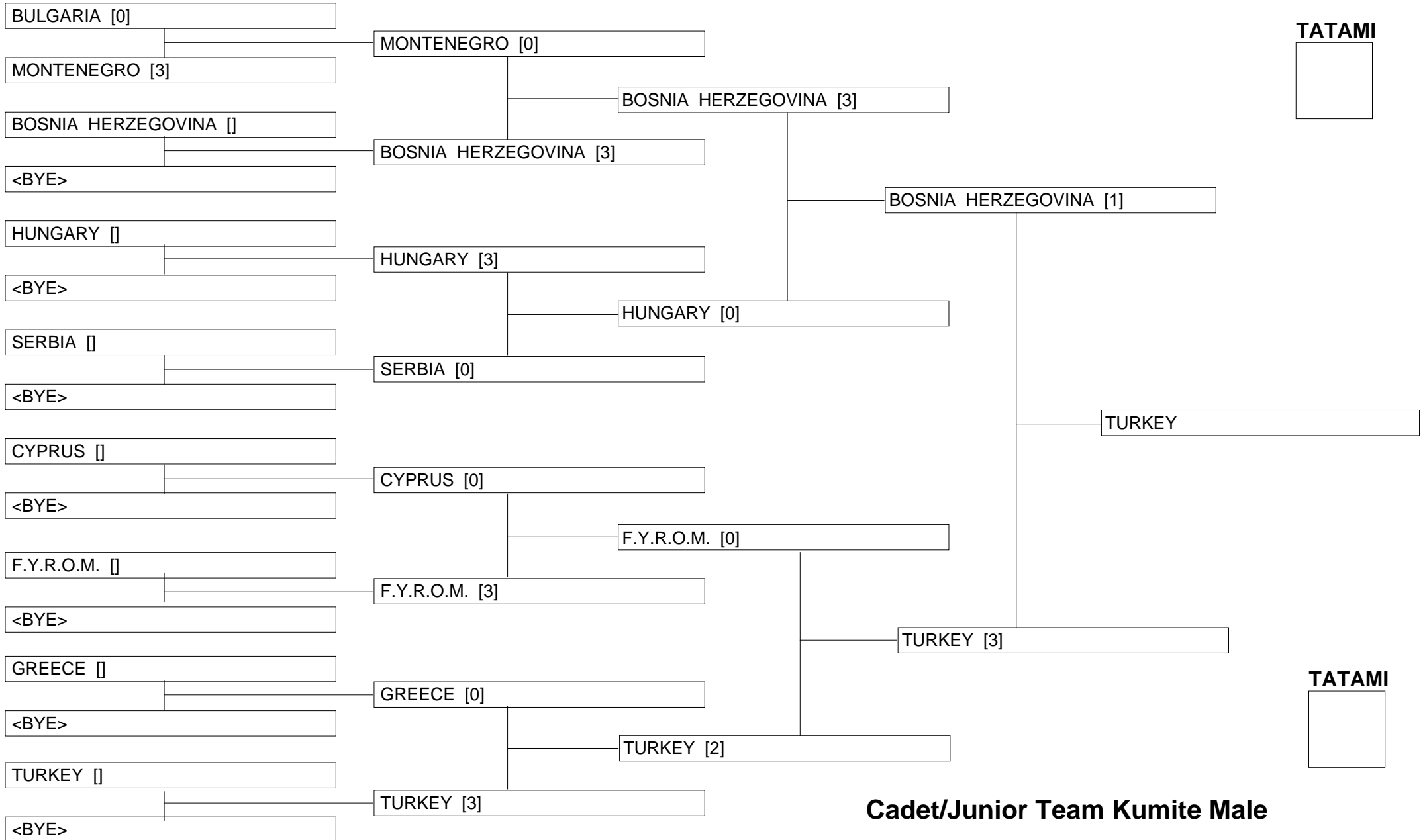

Cadet/Junior Team Kumite Male



14th Balkan Cadet & Junior 3th U21 18th Children

SERBIA - Kragujevac

29/3/2013 - 31/3/2013

Cadet/Junior Team Kumite Male

Repechage Pool 1

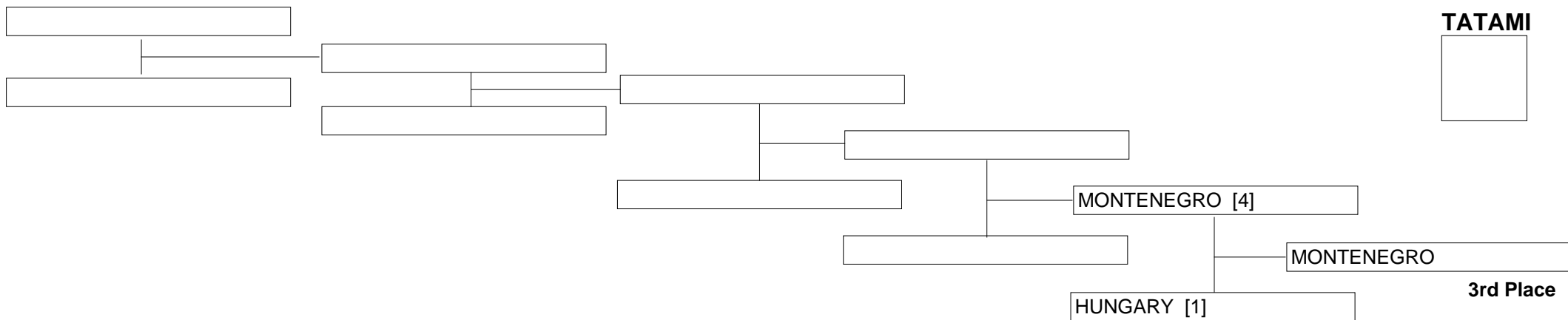

Repechage Pool 2

Cadet/Junior Team Kumite Male

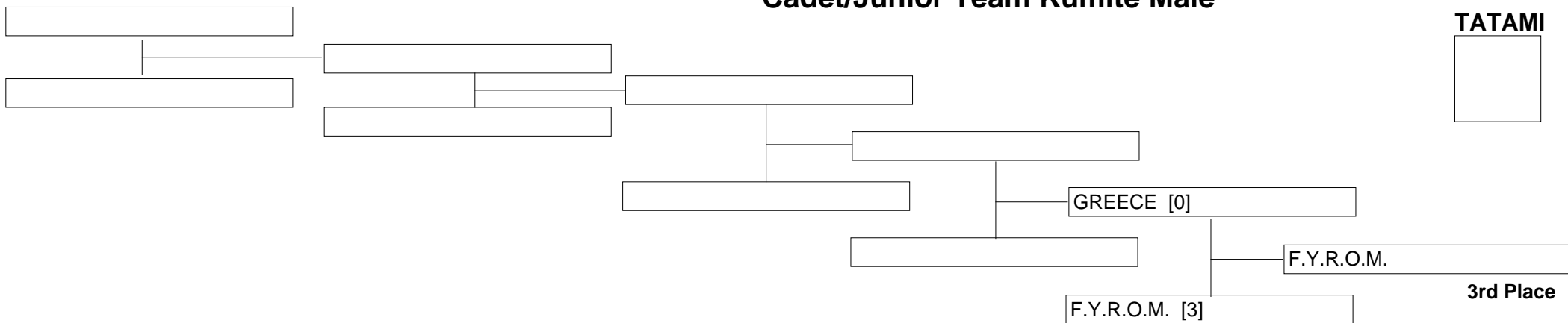



14th Balkan Cadet & Junior 3th U21 18th Children

SERBIA - Kragujevac

29/3/2013 - 31/3/2013

Cadet/Junior Team Kumite Female

Entries: 8

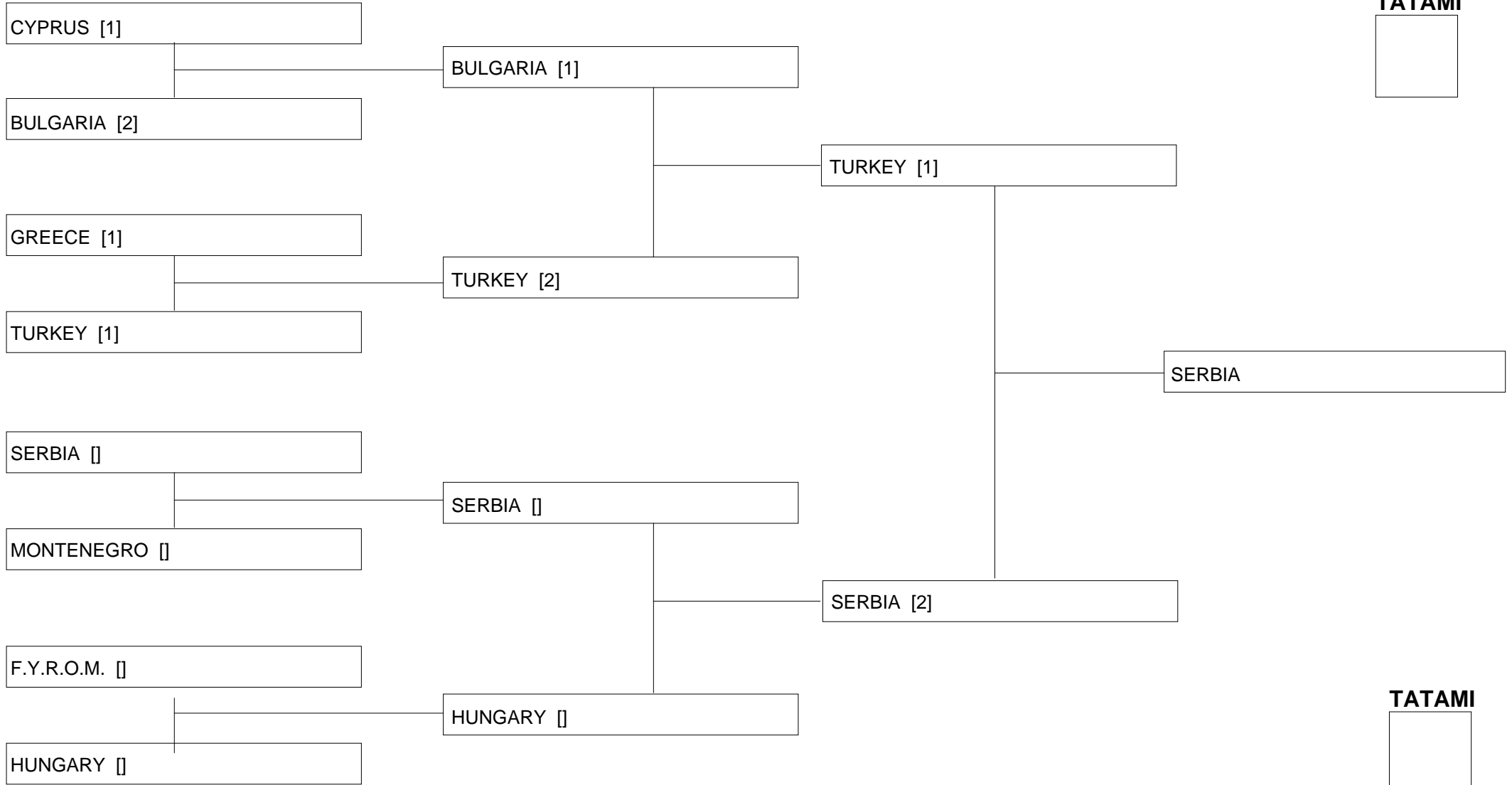

Cadet/Junior Team Kumite Female



14th Balkan Cadet & Junior 3th U21 18th Children

SERBIA - Kragujevac

29/3/2013 - 31/3/2013

Cadet/Junior Team Kumite Female

Repechage Pool 1

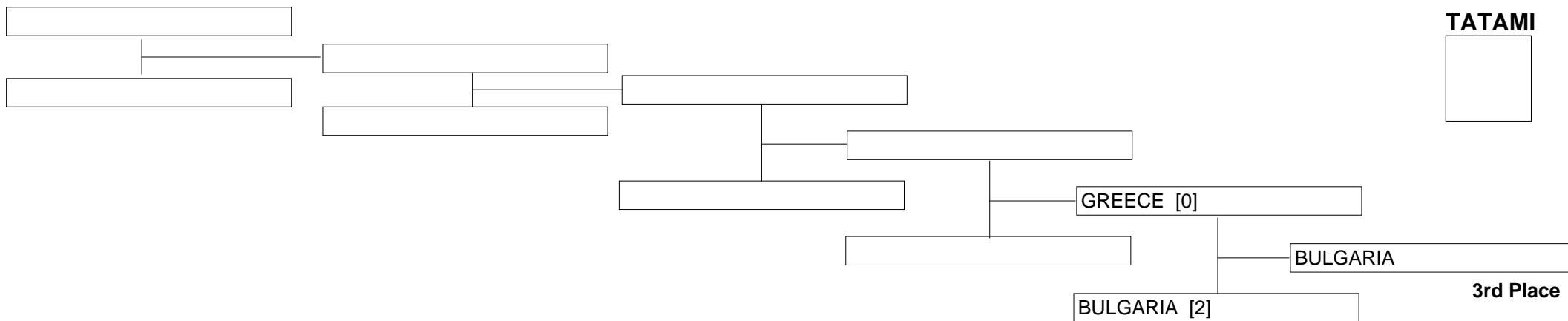

Repechage Pool 2

Cadet/Junior Team Kumite Female

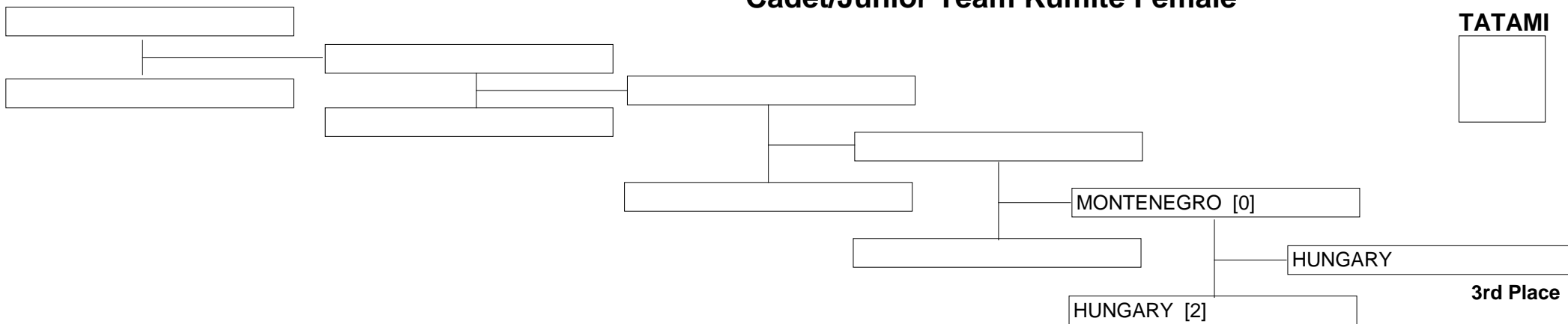



14th Balkan Cadet & Junior 3th U21 18th Children

SERBIA - Kragujevac

29/3/2013 - 31/3/2013

Under 21 Kata Male

Entries: 18

MNE187 S.PAJOVIC [Gsh/Sho]
TUR291 A.ALTUNTAS [Gsh/Sho]
BUL209 S.DINEV []
<BYE>
GRE285 G.TZIMIKAS []
<BYE>
ALB158 A.BIBA []
<BYE>
FYR485 F.RISTESKI []
<BYE>
MNE258 D.VUKOTIC []
<BYE>
SRB184 M.MITROVIC []
<BYE>
HUN196 B.NAGY []
<BYE>
BUL223 A.SLAVKOV [Sup/mpei]
TUR290 A.ALKAN [Nipaipo]
BIH352 M.JASARSPAHIC []
<BYE>
GRE242 P.KLEVAR []
<BYE>
SRB199 S.CHEMLAL []
<BYE>
GRE298 S.KONSTANTOPOUL
<BYE>
SRB189 R.MIJANOVIC []
<BYE>
HUN216 M.GRECZI []
<BYE>
MNE257 M.VRATNICA []
<BYE>

MNE187 S.PAJOVIC [Enpi]
MNE187 S.PAJOVIC [Unsu]
BUL209 S.DINEV [Sup/mpei]
GRE285 G.TZIMIKAS []
GRE285 G.TZIMIKAS [Kank Sh]
ALB158 A.BIBA []
FYR485 F.RISTESKI [Kank Sh]
MNE258 D.VUKOTIC [Unsu]
MNE258 D.VUKOTIC [Enpi]
SRB184 M.MITROVIC [Unsu]
SRB184 M.MITROVIC [Gsh/Sh]
HUN196 B.NAGY [Chat Kus]
TUR290 A.ALKAN [Paiku]
TUR290 A.ALKAN [Chat Kus]
BIH352 M.JASARSPAHIC [Gsh]
GRE242 P.KLEVAR [Kos Dai]
SRB199 S.CHEMLAL [Gsh/Sho]
SRB199 S.CHEMLAL [Kank Sh]
GRE298 S.KONSTANTOPOUL
SRB189 R.MIJANOVIC [Gsh/S]
SRB189 R.MIJANOVIC [Kank]
HUN216 M.GRECZI [Nipaipo]
MNE257 M.VRATNICA [Gsh/S]
MNE257 M.VRATNICA [Kank S]

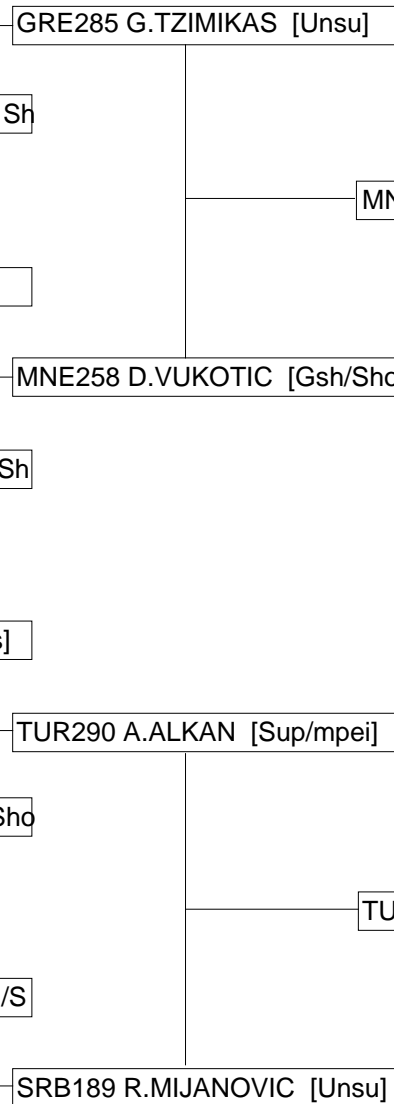
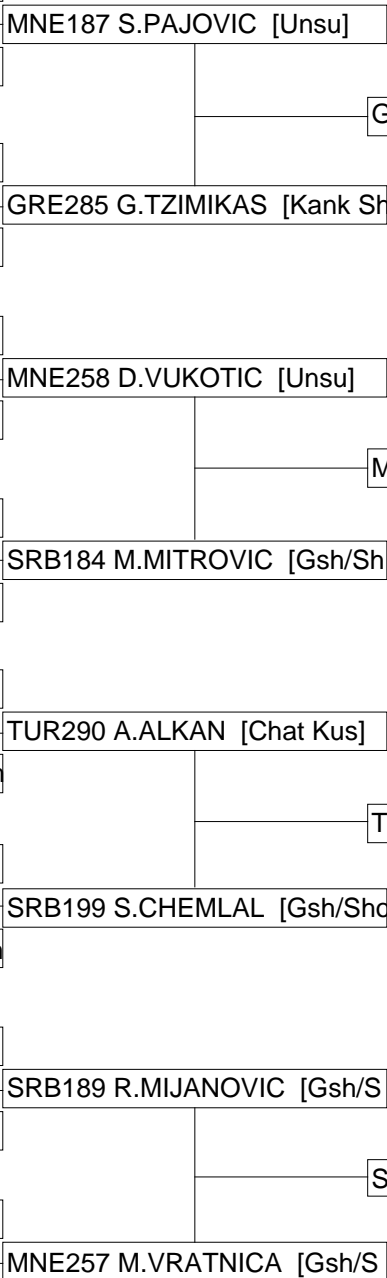

Pool 1

TATAMI



TATAMI

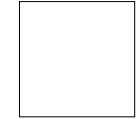

Pool 2

Under 21 Kata Male



14th Balkan Cadet & Junior 3th U21 18th Children

SERBIA - Kragujevac

29/3/2013 - 31/3/2013

Under 21 Kata Male

Repechage Pool 1

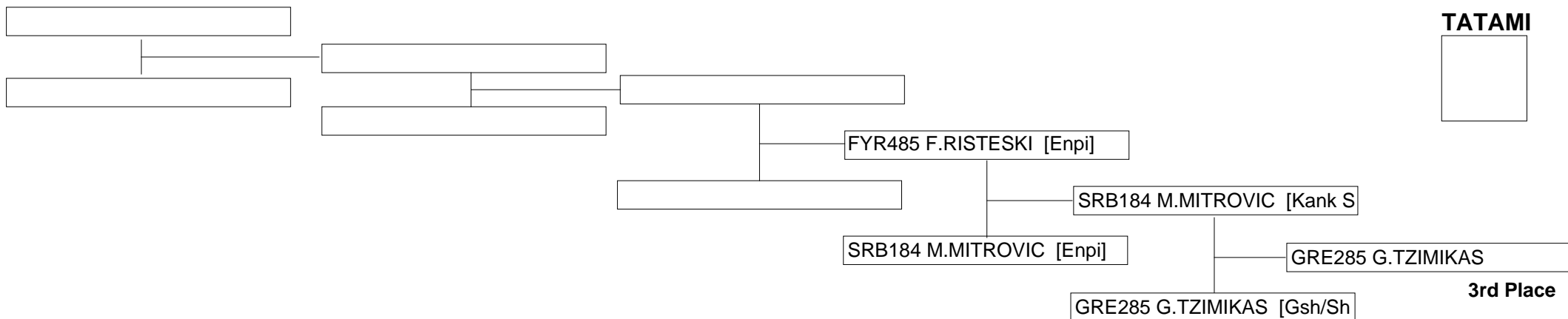

Repechage Pool 2

Under 21 Kata Male

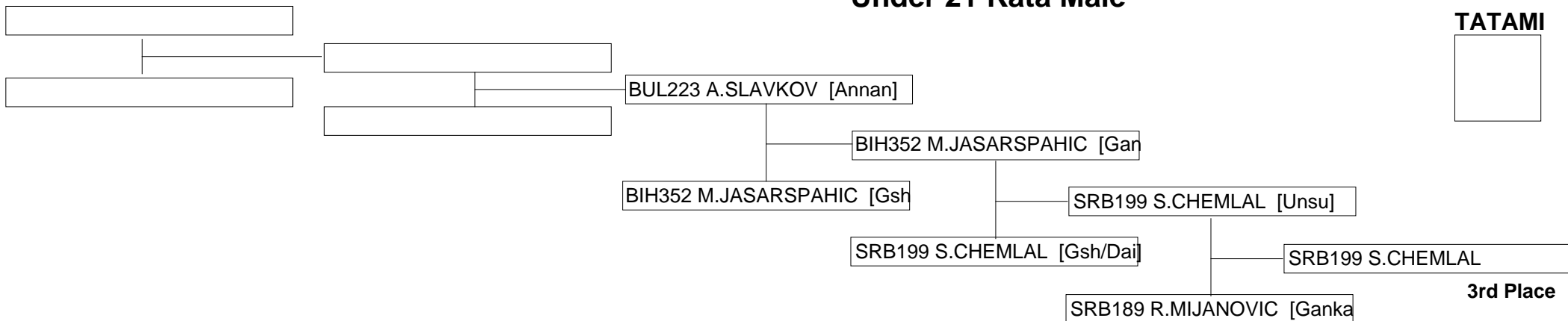



14th Balkan Cadet & Junior 3th U21 18th Children

SERBIA - Kragujevac

29/3/2013 - 31/3/2013

Under 21 Kata Female

Entries: 13

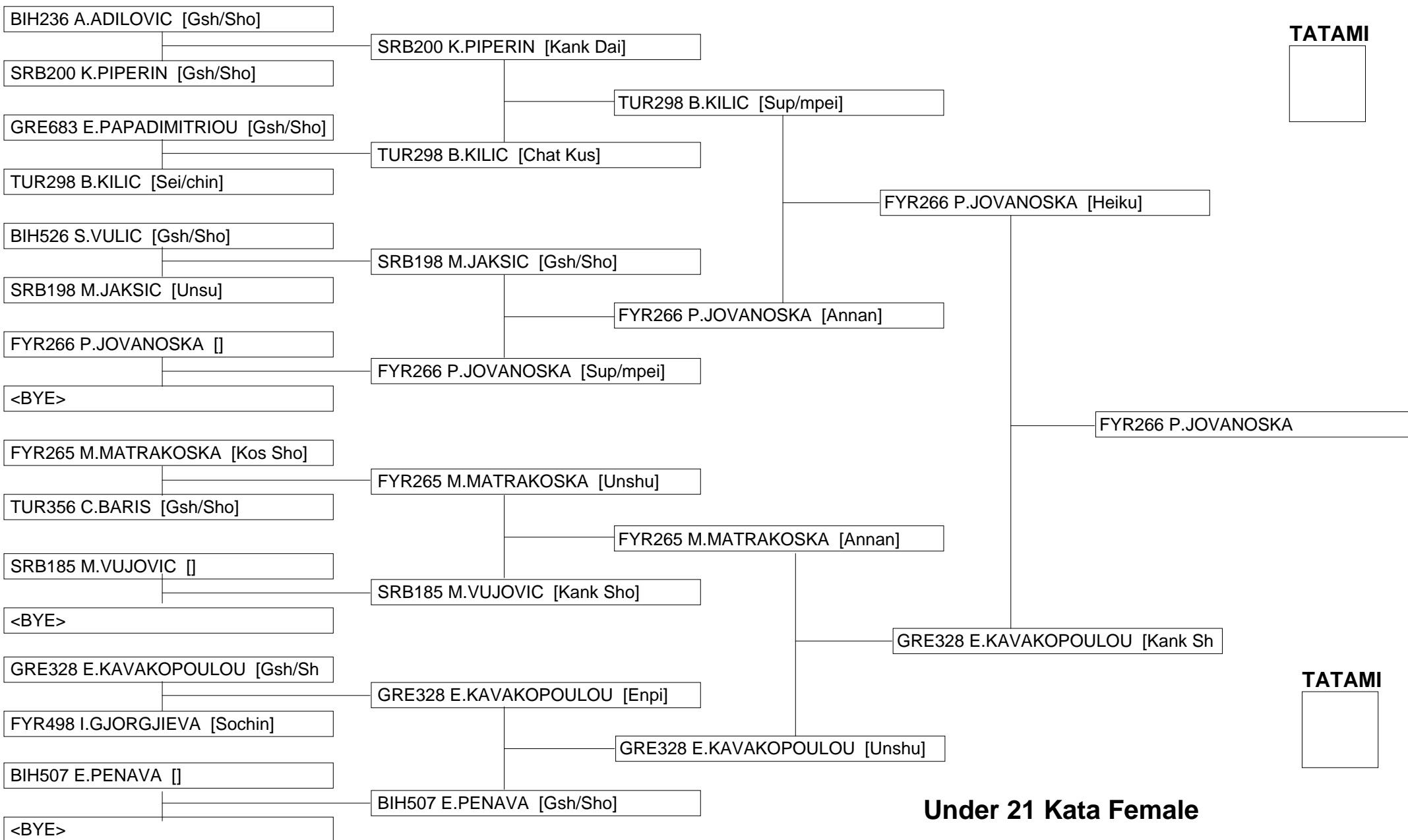



14th Balkan Cadet & Junior 3th U21 18th Children

SERBIA - Kragujevac

29/3/2013 - 31/3/2013

Under 21 Kata Female

Repechage Pool 1

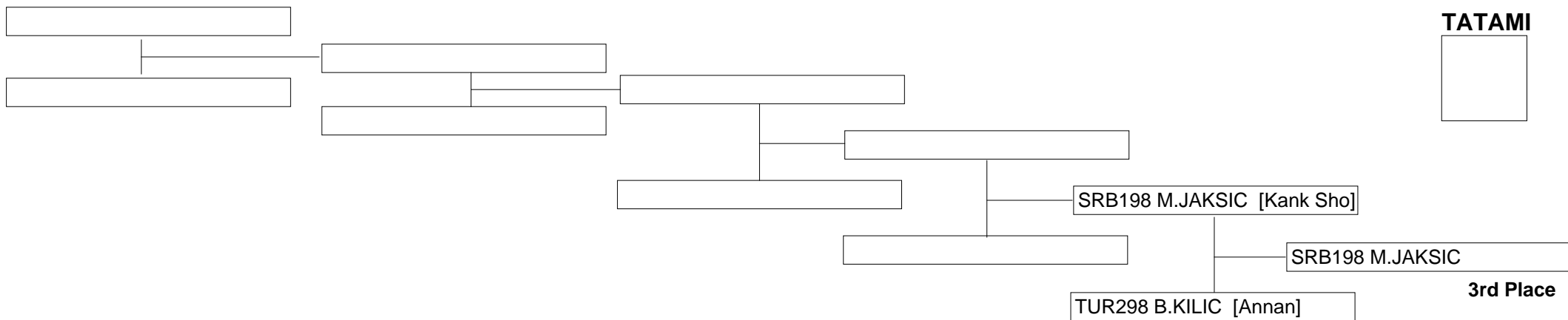

Repechage Pool 2

Under 21 Kata Female

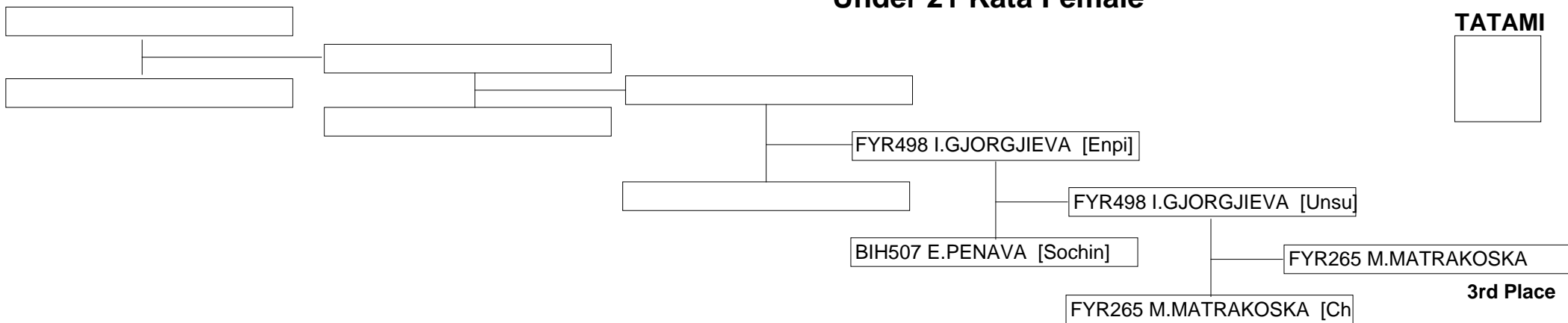



14th Balkan Cadet & Junior 3th U21 18th Children

SERBIA - Kragujevac

29/3/2013 - 31/3/2013

Under 21 Kumite Male 78+ kg

Entries: 18

CYR185 L.LOUKA [1]
BIH502 B.NURKIC [0]
HUN209 A.PELLER []
<BYE>
SRB338 V.ALEKSIC []
<BYE>
FYR243 B.JAKUPI []
<BYE>
GRE286 A.KOUKOURITAKIS []
<BYE>
BIH276 H.HALILOVIC []
<BYE>
SLO216 J.MARKAC []
<BYE>
SRB488 B.MATIC []
<BYE>
FYR354 S.ANTIKJ [6]
HUN291 A.KELEMEN [0]
BUL209 S.DINEV []
<BYE>
SRB176 A.SESEKOV []
<BYE>
MNE151 V.SUKOVIC []
<BYE>
GRE241 D.MOULAVASILIS []
<BYE>
FYR271 N.ILOVSKI []
<BYE>
CYR325 G.PSATHAS []
<BYE>
BIH264 B.MEHOVIC []
<BYE>





14th Balkan Cadet & Junior 3th U21 18th Children

SERBIA - Kragujevac

29/3/2013 - 31/3/2013

Under 21 Kumite Male 78+ kg

Repechage Pool 1

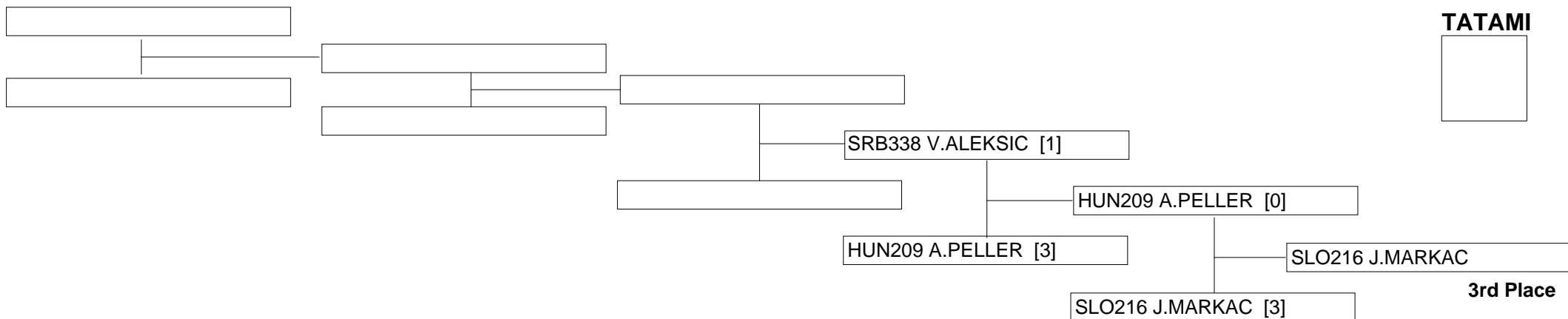

Repechage Pool 2

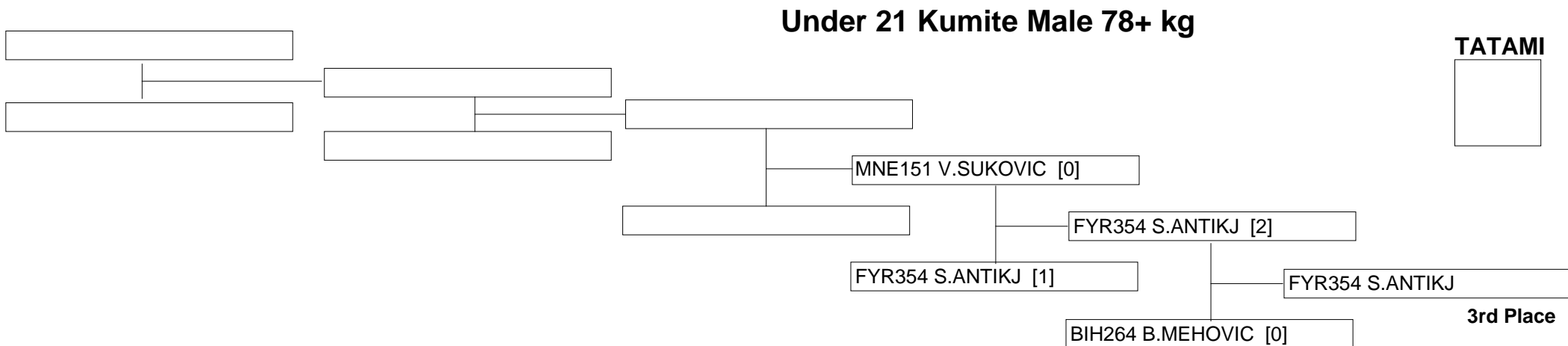



14th Balkan Cadet & Junior 3th U21 18th Children

SERBIA - Kragujevac

29/3/2013 - 31/3/2013

Under 21 Kumite Male -68 kg

Entries: 24

GRE320 G.KOSTOUROS [3]
FYR353 I.TASHOV [4]

FYR353 I.TASHOV [0]

SRB214 N.KELEBIC []
<BYE>

SRB214 N.KELEBIC [5]
SRB214 N.KELEBIC [2]

MNE260 I.DABOVIC [1]
BIH230 S.TABAKOVIC [6]

BIH230 S.TABAKOVIC [8]
BIH230 S.TABAKOVIC [5]

ALB179 A.PRENGA []
<BYE>

ALB179 A.PRENGA [0]

SRB547 N.BARAC [1]
BIH530 A.BALTA [1]

SRB547 N.BARAC [1]
GRE233 M.GIANNELIS [7]

GRE233 M.GIANNELIS []
<BYE>

GRE233 M.GIANNELIS [3]
HUN184 D.SZEGEDI [4]

TUR507 B.AKBULUT [1]
HUN184 D.SZEGEDI [2]

HUN184 D.SZEGEDI [3]
HUN184 D.SZEGEDI [8]

MNE276 V.JOVIC []
<BYE>

MNE276 V.JOVIC [0]

ROM200 A.DUTA [2]
MNE148 S.DUKIC [9]

MNE148 S.DUKIC [7]
MNE148 S.DUKIC [0]

HUN183 D.JURCA []
<BYE>

HUN183 D.JURCA [0]

BUL213 V.DIMITROV [5]
CYR181 P.LOIZIDES [7]

CYR181 P.LOIZIDES [8]
CYR181 P.LOIZIDES [8]

TUR291 A.ALTUNTAS []
<BYE>

TUR291 A.ALTUNTAS [0]

GRE657 A.KANARIS [8]
BIH237 M.HRKAC [0]

GRE657 A.KANARIS [1]
FYR264 F.GJURCINOVSKI [6]

FYR264 F.GJURCINOVSKI []
<BYE>

FYR264 F.GJURCINOVSKI [5]
FYR264 F.GJURCINOVSKI [3]

ALB170 E.JAKU [0]
SRB428 N.BOZOVIC [8]

SRB428 N.BOZOVIC [0]
HUN189 Z.KOHEGYI [2]

HUN189 Z.KOHEGYI []
<BYE>

HUN189 Z.KOHEGYI [2]

BIH230 S.TABAKOVIC [5]

BIH230 S.TABAKOVIC [5]

HUN184 D.SZEGEDI [4]

BIH230 S.TABAKOVIC

CYR181 P.LOIZIDES [2]

FYR264 F.GJURCINOVSKI [3]

FYR264 F.GJURCINOVSKI [3]

Pool 1

TATAMI

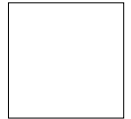

TATAMI

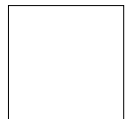

Pool 2

Under 21 Kumite Male -68 kg



14th Balkan Cadet & Junior 3th U21 18th Children

SERBIA - Kragujevac

29/3/2013 - 31/3/2013

Under 21 Kumite Male -68 kg

Repechage Pool 1

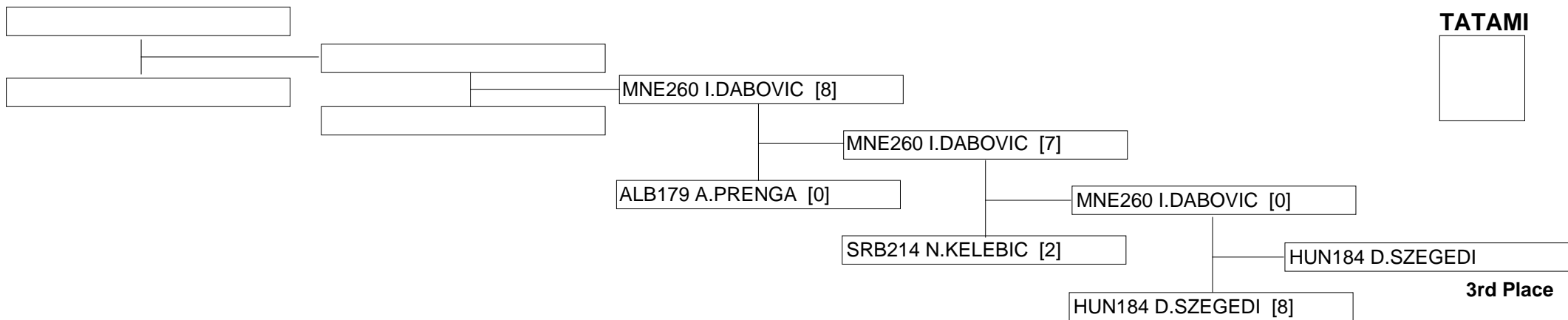

Repechage Pool 2

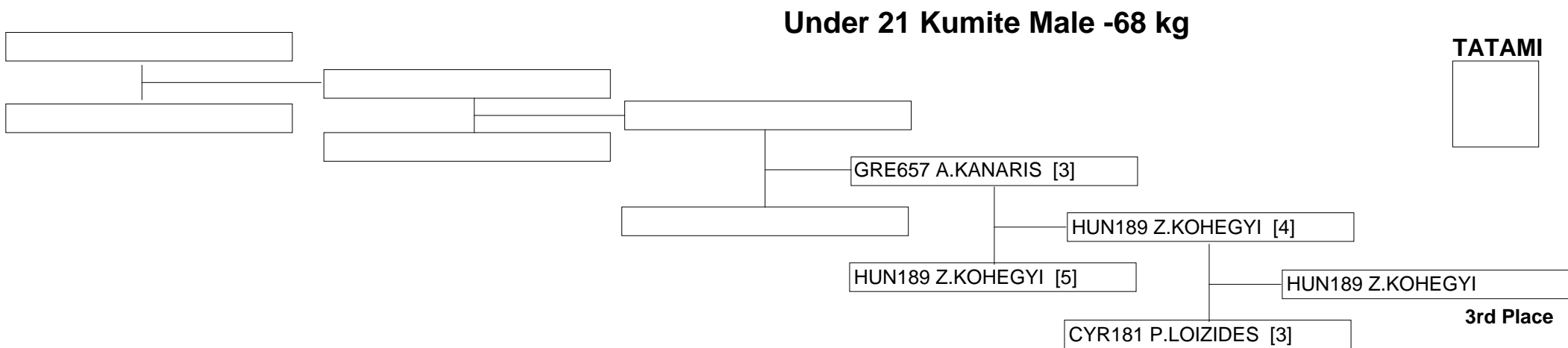



14th Balkan Cadet & Junior 3th U21 18th Children

SERBIA - Kragujevac

29/3/2013 - 31/3/2013

Under 21 Kumite Male -78 kg

Entries: 24

MNE177 A.LICINA [2]
ALB162 S.SELAMI [3]
FYR244 M.PETRESKI []
<BYE>
CRO349 D.ALEKSIC [9]
BUL365 A.MLADENOV [1]
GRE770 N.BIRIS []
<BYE>
SRB210 U.STOJCOV [2]
BIH515 H.SEFEROVIC [4]
GRE306 N.KOSMAS []
<BYE>
FYR362 E.KJOSOVIKJ [0]
BUL367 P.MOSHEKOV [8]
TUR769 M.AYDOGDU []
<BYE>
CRO403 M.HASANI [1]
SRB247 U.MIJALKOVIC [9]
TUR375 A.DURADEMIR []
<BYE>
BIH407 S.MESIC [4]
GRE235 D.GKOREZIS [0]
SLO234 F.SPANBAUER []
<BYE>
BUL208 S.PETKOV [4]
SRB231 D.LICINA [6]
ALB160 D.HAJTA []
<BYE>
FYR496 M.DIMOVSKI [1]
HUN307 A.HONING [9]
BIH348 D.GOGIC []
<BYE>

ALB162 S.SELAMI [1]
FYR244 M.PETRESKI [2]
FYR244 M.PETRESKI [4]
CRO349 D.ALEKSIC [3]
CRO349 D.ALEKSIC [0]
GRE770 N.BIRIS [0]
BIH515 H.SEFEROVIC [0]
GRE306 N.KOSMAS [6]
GRE306 N.KOSMAS [8]
BUL367 P.MOSHEKOV [6]
BUL367 P.MOSHEKOV [0]
TUR769 M.AYDOGDU [1]
SRB247 U.MIJALKOVIC [0]
TUR375 A.DURADEMIR [0]
TUR375 A.DURADEMIR [8]
BIH407 S.MESIC [0]
SLO234 F.SPANBAUER [8]
SLO234 F.SPANBAUER [7]
SRB231 D.LICINA [5]
SRB231 D.LICINA [8]
ALB160 D.HAJTA [0]
HUN307 A.HONING [4]
HUN307 A.HONING [0]
BIH348 D.GOGIC [3]

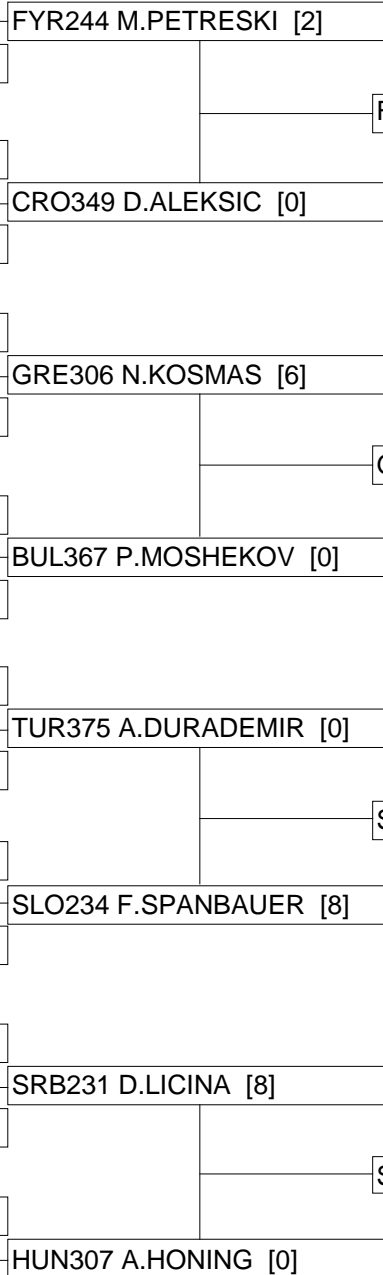

FYR244 M.PETRESKI [0]

GRE306 N.KOSMAS [8]

GRE306 N.KOSMAS [1]

GRE306 N.KOSMAS

SLO234 F.SPANBAUER [4]

SLO234 F.SPANBAUER [8]

SLO234 F.SPANBAUER [4]

SRB231 D.LICINA [1]

Under 21 Kumite Male -78 kg

Pool 1

TATAMI

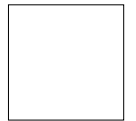

TATAMI

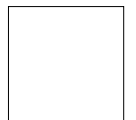

Pool 2



14th Balkan Cadet & Junior 3th U21 18th Children

SERBIA - Kragujevac

29/3/2013 - 31/3/2013

Under 21 Kumite Male -78 kg

Repechage Pool 1

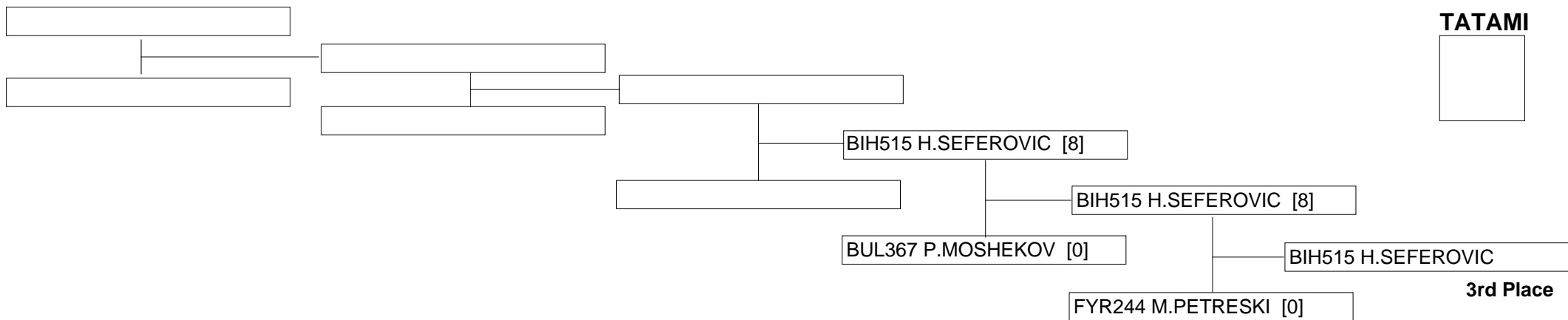

Repechage Pool 2

Under 21 Kumite Male -78 kg

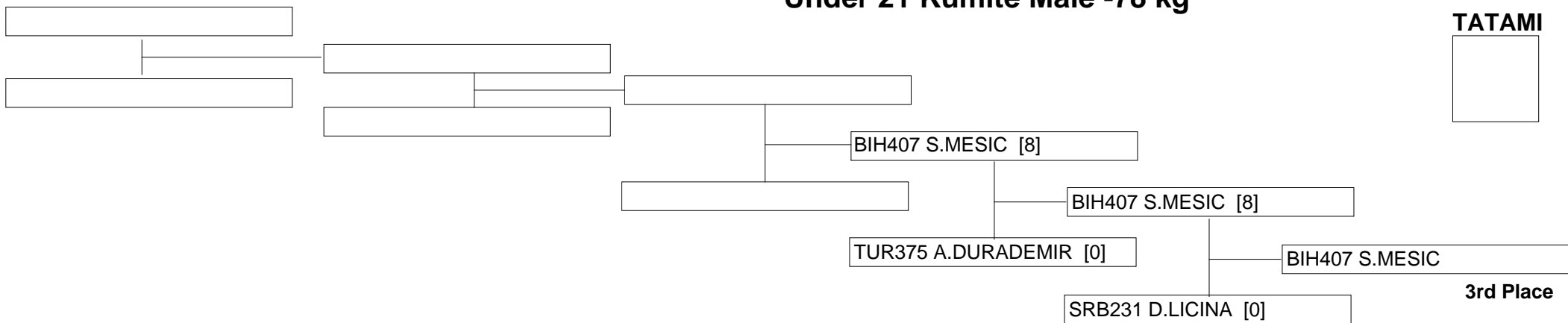



14th Balkan Cadet & Junior 3th U21 18th Children

SERBIA - Kragujevac

29/3/2013 - 31/3/2013

Under 21 Kumite Female 60+ kg

Entries: 14

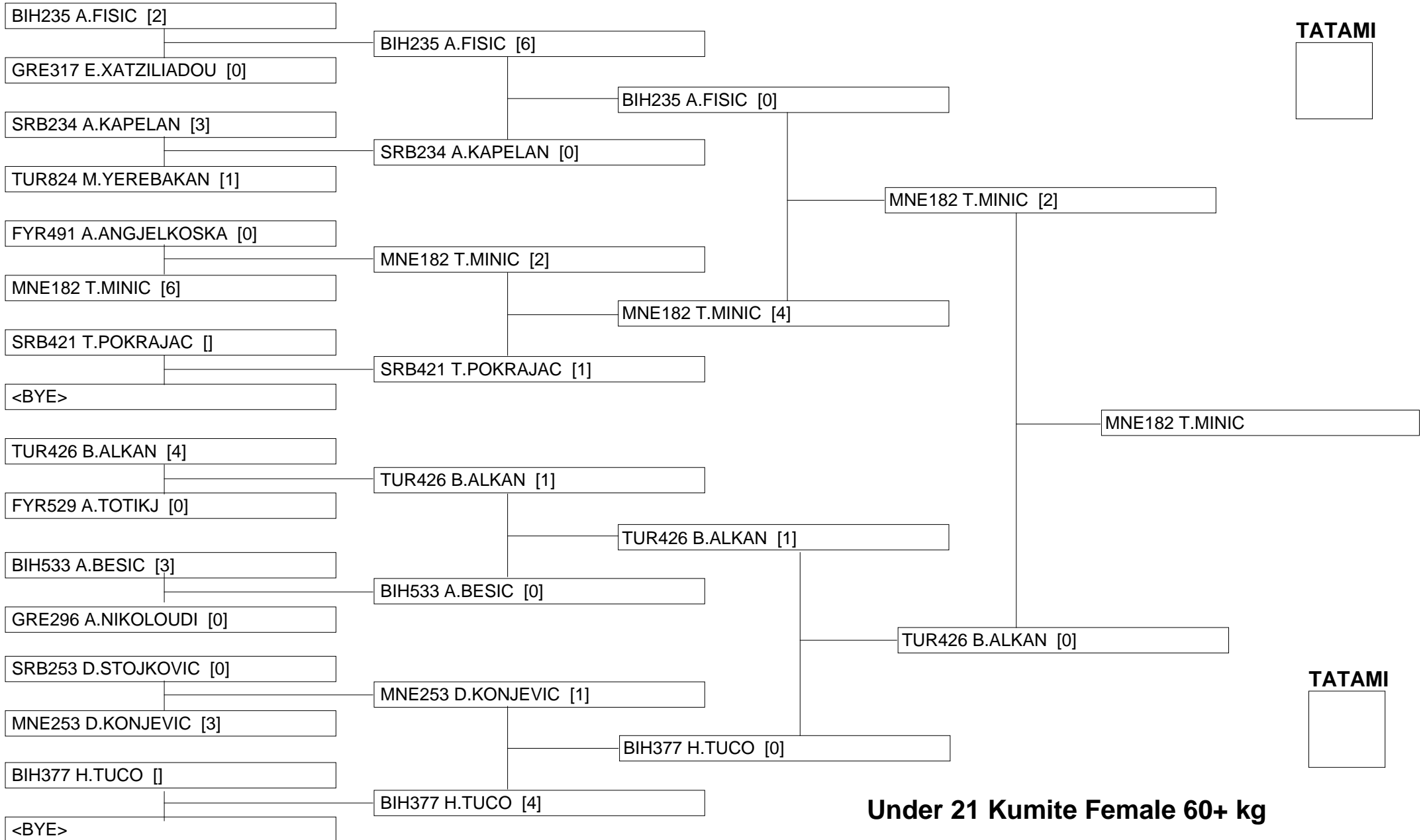

Under 21 Kumite Female 60+ kg



14th Balkan Cadet & Junior 3th U21 18th Children

SERBIA - Kragujevac

29/3/2013 - 31/3/2013

Under 21 Kumite Female 60+ kg

Repechage Pool 1

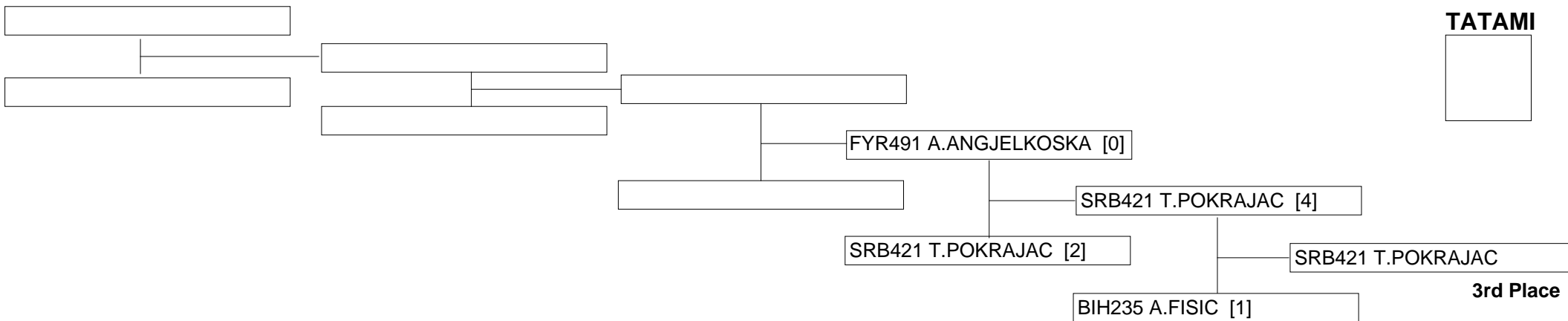

Repechage Pool 2

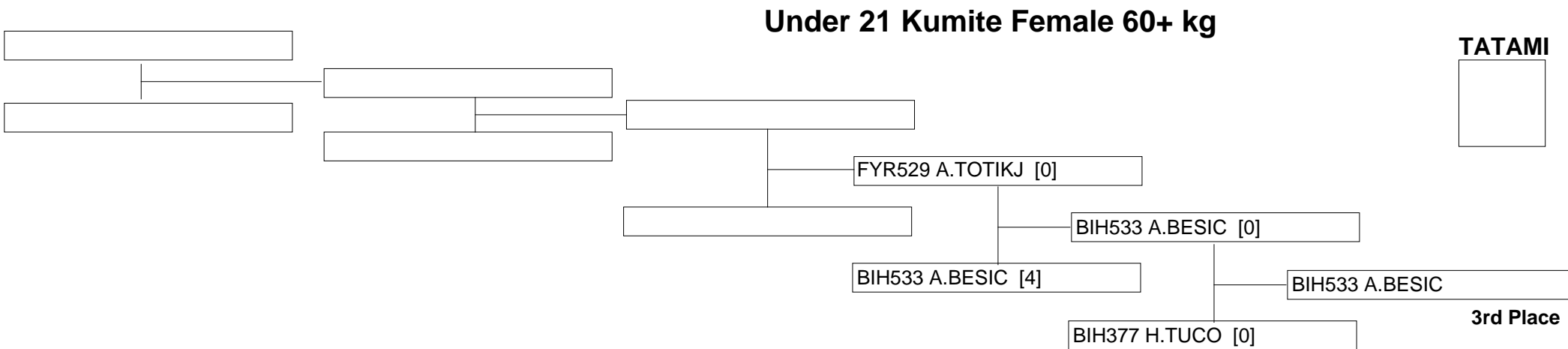



14th Balkan Cadet & Junior 3th U21 18th Children

SERBIA - Kragujevac

29/3/2013 - 31/3/2013

Under 21 Kumite Female -53 kg

Entries: 18

GRE328 E.KAVAKOPOULOU []
MNE155 A.DRASKOVIC [5]
HUN227 A.KUCSERA []
<BYE>
BIH503 N.OMEROVIC []
<BYE>
ROM273 D.POLEAC []
<BYE>
TUR774 B.CAKIR []
<BYE>
FYR346 S.RADICEVSKA []
<BYE>
BIH564 L.BERBER []
<BYE>
SRB213 F.FAZLIC []
<BYE>
ROM232 F.GOGOT [8]
SRB180 J.PETROV [0]
MNE153 M.KASTRATOVIC []
<BYE>
CRO404 A.HASANI []
<BYE>
GRE683 E.PAPADIMITRIOU []
<BYE>
FYR250 T.BOSKOSKA []
<BYE>
TUR692 E.AKKURT []
<BYE>
SRB466 M.JOVANOVIC []
<BYE>
BIH236 A.ADILOVIC []
<BYE>

MNE155 A.DRASKOVIC [3]
MNE155 A.DRASKOVIC [7]
HUN227 A.KUCSERA [0]
BIH503 N.OMEROVIC [0]
ROM273 D.POLEAC [0]
ROM273 D.POLEAC [6]
TUR774 B.CAKIR [8]
TUR774 B.CAKIR [3]
FYR346 S.RADICEVSKA [0]
BIH564 L.BERBER [1]
SRB213 F.FAZLIC [0]
SRB213 F.FAZLIC [5]
ROM232 F.GOGOT [0]
MNE153 M.KASTRATOVIC [0]
MNE153 M.KASTRATOVIC [2]
CRO404 A.HASANI [2]
CRO404 A.HASANI [8]
GRE683 E.PAPADIMITRIOU [0]
FYR250 T.BOSKOSKA [0]
TUR692 E.AKKURT [2]
SRB466 M.JOVANOVIC [1]
BIH236 A.ADILOVIC [0]
BIH236 A.ADILOVIC [2]

MNE155 A.DRASKOVIC [5]
ROM273 D.POLEAC [0]
TUR774 B.CAKIR [0]
TUR774 B.CAKIR [6]
SRB213 F.FAZLIC [0]
MNE153 M.KASTRATOVIC [0]
CRO404 A.HASANI [5]
CRO404 A.HASANI [8]
TUR692 E.AKKURT [8]
TUR692 E.AKKURT [0]
BIH236 A.ADILOVIC [0]

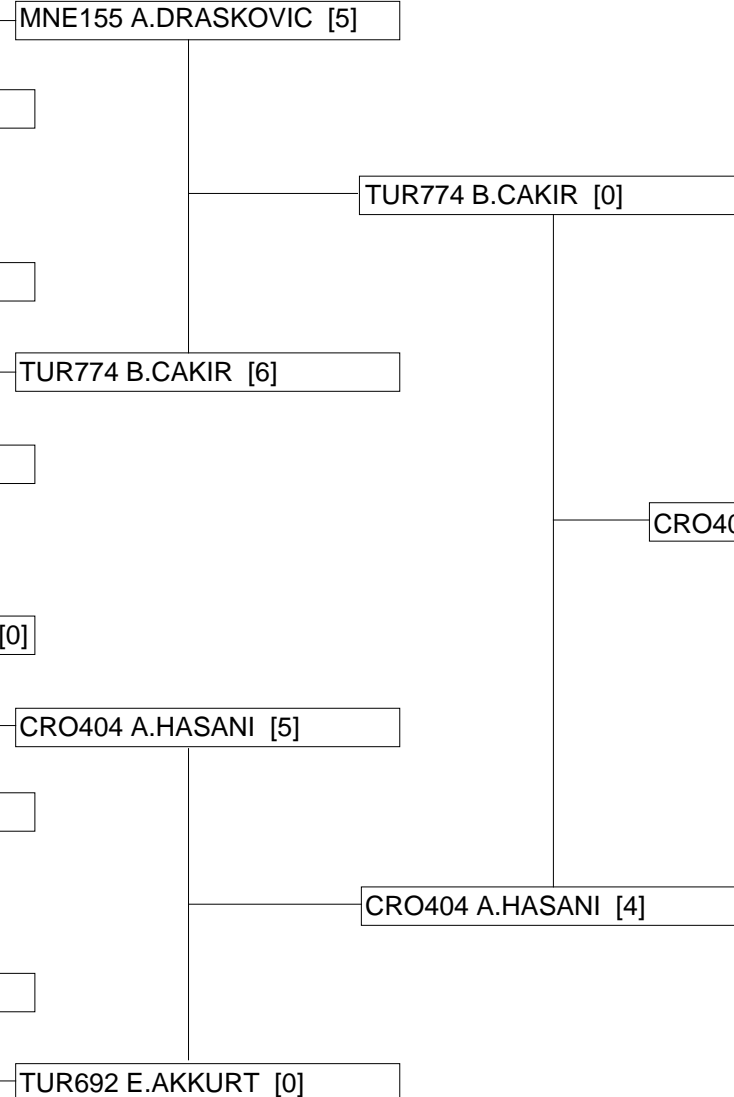

Pool 1

TATAMI

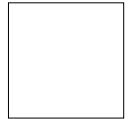

TATAMI

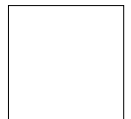

Pool 2

Under 21 Kumite Female -53 kg



14th Balkan Cadet & Junior 3th U21 18th Children

SERBIA - Kragujevac

29/3/2013 - 31/3/2013

Under 21 Kumite Female -53 kg

Repechage Pool 1

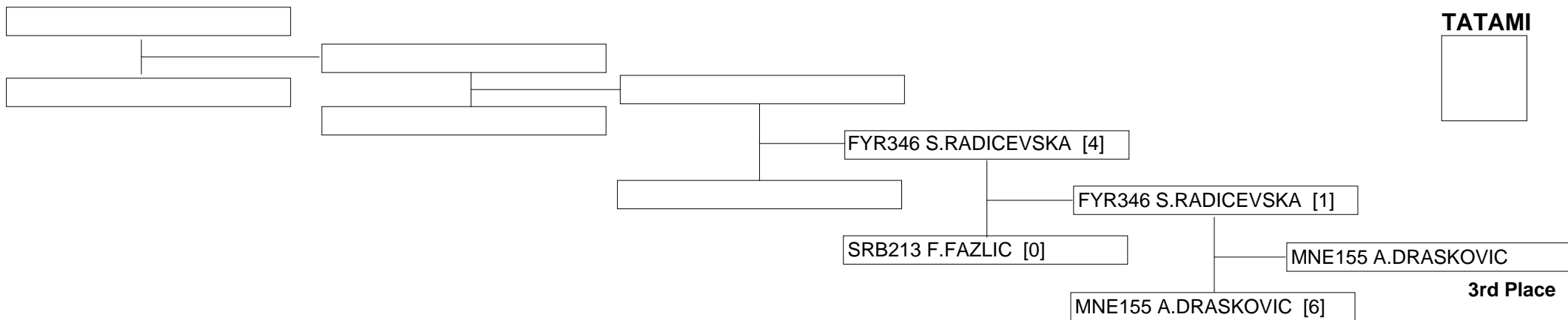

Repechage Pool 2

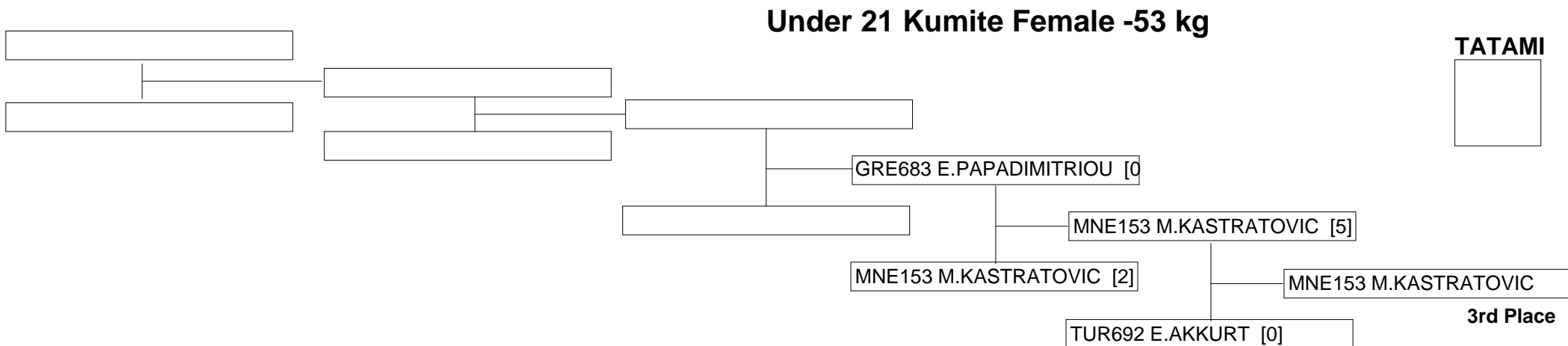



14th Balkan Cadet & Junior 3th U21 18th Children

SERBIA - Kragujevac

29/3/2013 - 31/3/2013

Under 21 Kumite Female -60 kg

Entries: 16

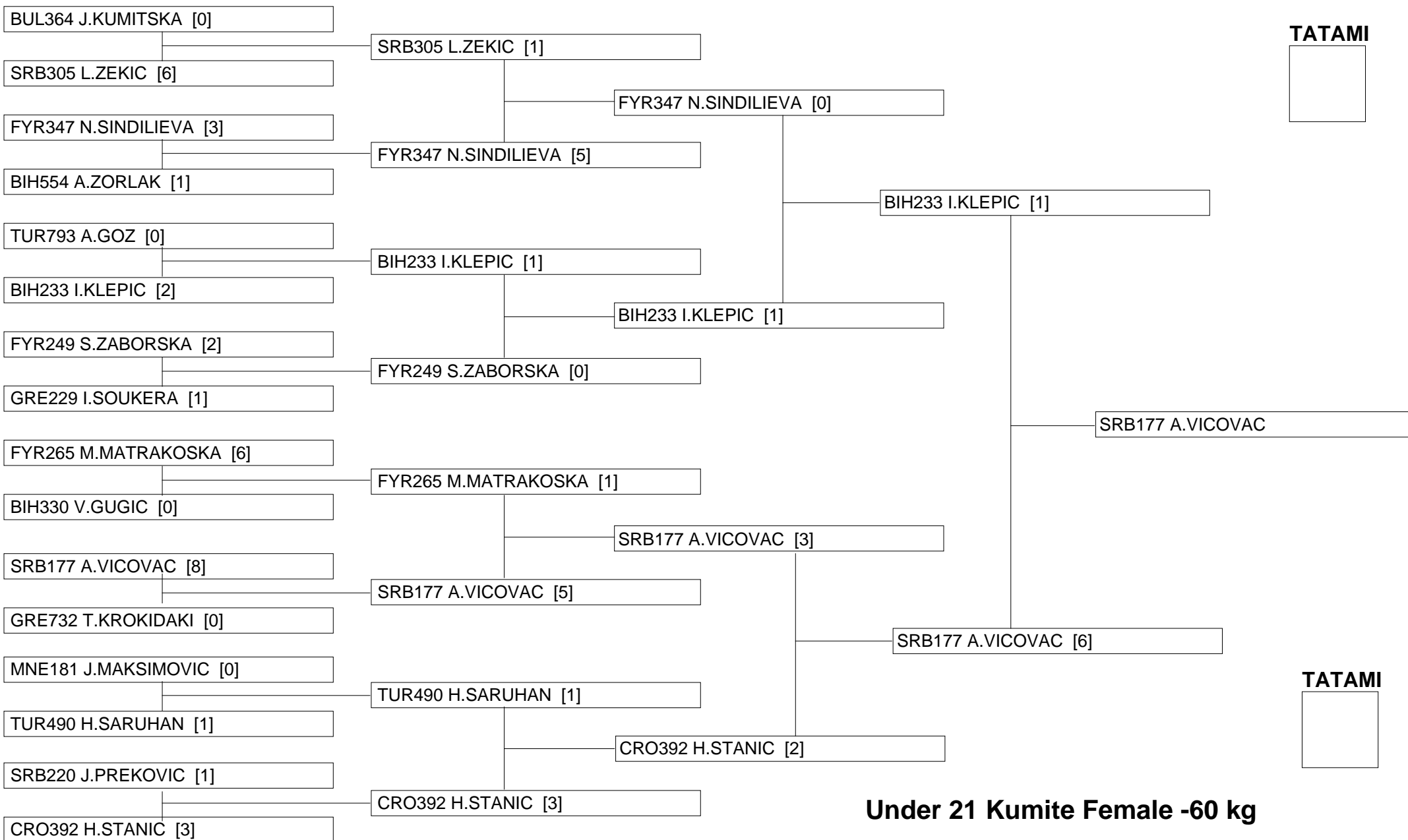



14th Balkan Cadet & Junior 3th U21 18th Children

SERBIA - Kragujevac

29/3/2013 - 31/3/2013

Under 21 Kumite Female -60 kg

Repechage Pool 1

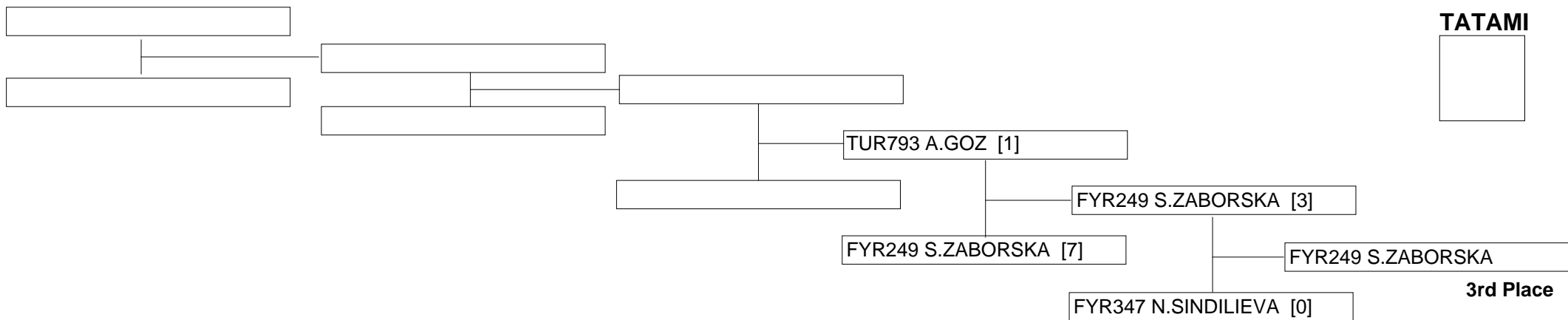

Repechage Pool 2

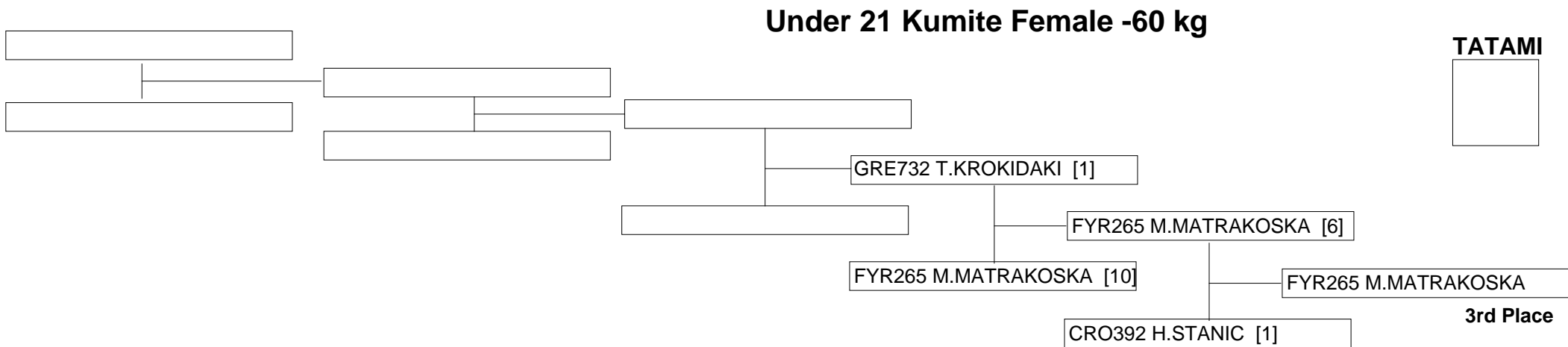



14th Balkan Cadet & Junior 3th U21 18th Children

SERBIA - Kragujevac

29/3/2013 - 31/3/2013

Veteran 40+ Kata Male

Entries: 4

TATAMI

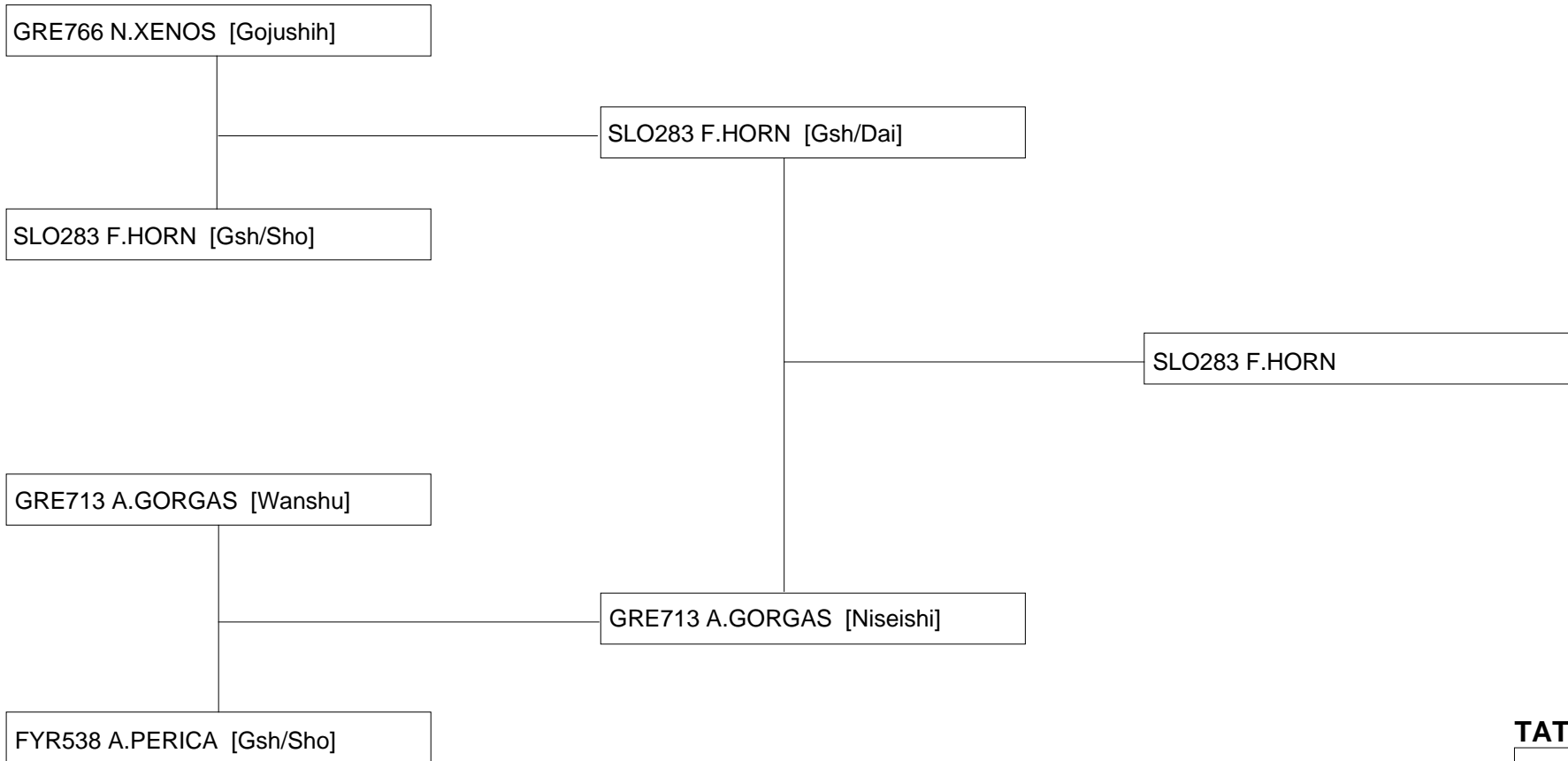
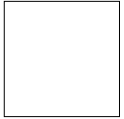

TATAMI



Veteran 40+ Kata Male



14th Balkan Cadet & Junior 3th U21 18th Children

SERBIA - Kragujevac

29/3/2013 - 31/3/2013

Veteran 40+ Kata Male

Repechage Pool 1

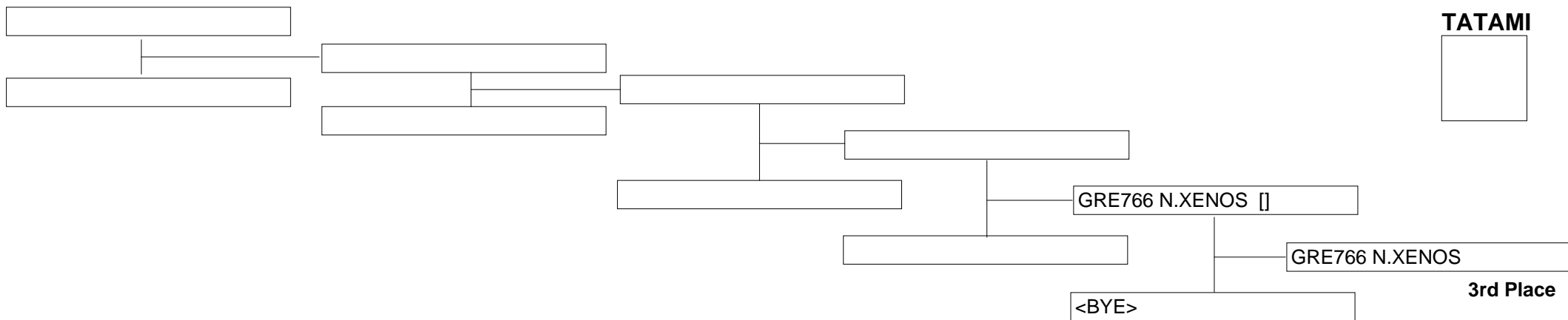

Repechage Pool 2

Veteran 40+ Kata Male

